



Education and Culture DG

Lifelong Learning Programme

LEONARDO DA VINCI – FRACOF+
INNOVATION TRANSFER ON FIRE RESISTANCE ASSESSMENT OF
PARTIALLY PROTECTED COMPOSITE FLOOR

Bazele metodei de proiectare la foc a planșeelor compuse

Conf. dr. ing. Raul Zaharia

Universitatea “Politehnica” Timisoara



PROGRAMUL DE INCERCARI LA FOC – CARDINGTON



Structura compusa otel-beton

P+7E

Dimensiuni in plan: 21m x 45m

Inaltime etaj: 4.2 m



Test 1: Grinda fixata lateral

Scop: investigarea comportamentului unei grinzi incalzite inconjurate de o structura neancalzita

- Grinda secundara (imbinari articulate) + structura adiacenta la nivelul 7
- Cuptor special pe gaz (8m x 3m): grinda incalzita 150 minute pe 8m (din cei 9m lungime), pastrand astfel imbinarile reci

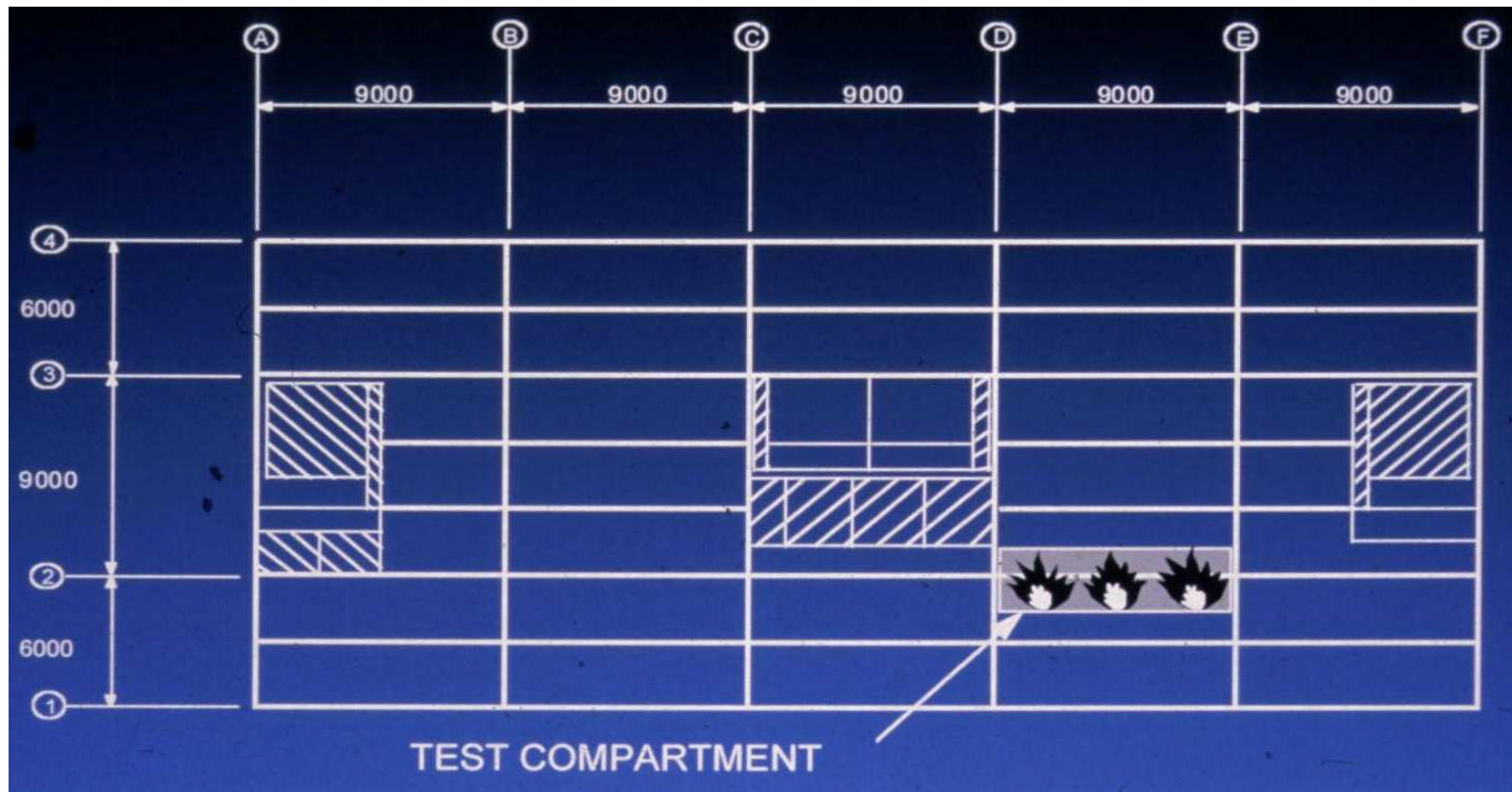

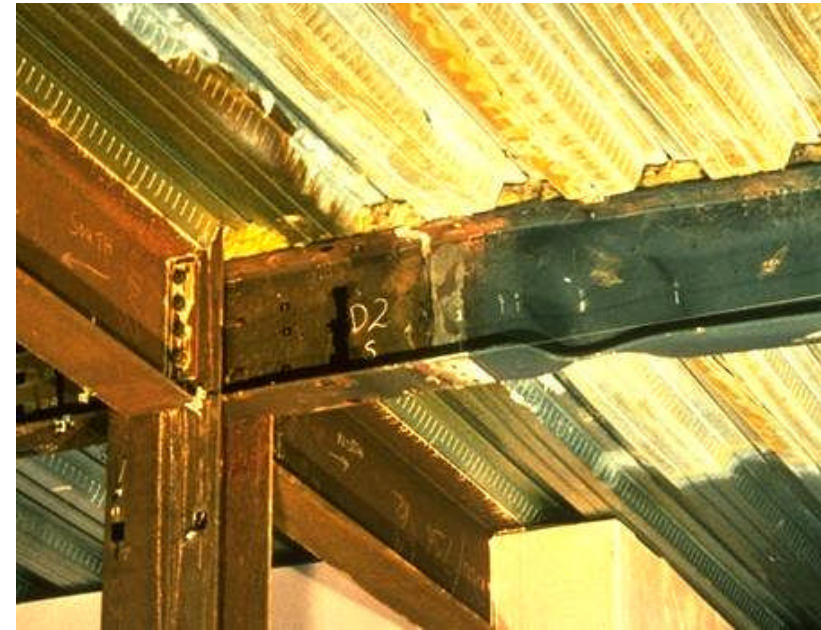
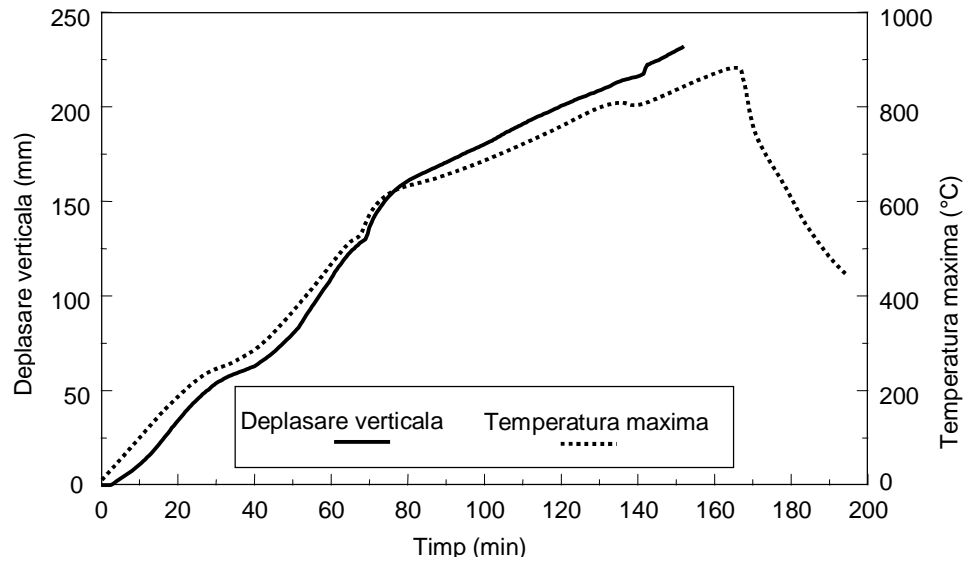

Sageata maxima 232 mm (L/39) la 150 minute

- nici un semn de cedare in timpul testului, doar o voalare locala a grinzii, in ambele capete, in interiorul zonei incalzite, in conditiile in care la 900°C oțelul pastreaza aproximativ 6% din limita de curgere initiala;
- grinda izolata simplu rezemata cu aceeasi sectiune compusa/ deschidere/ incarcare cedeaza la aproximativ 650°C

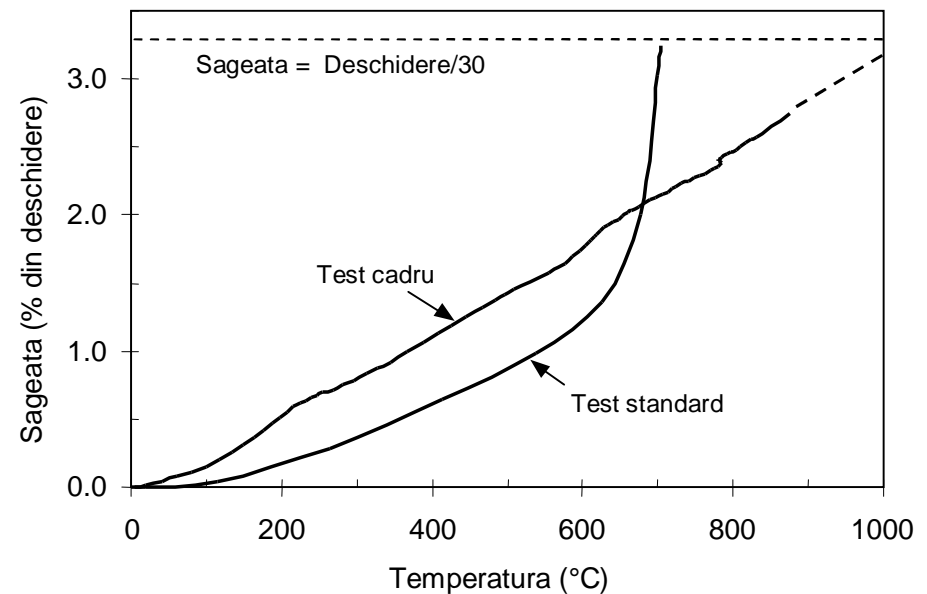

Test 2: Cadru plan

Scop: investigarea comportamentului unui cadru transversal, compus din 4 stalpi si 3 grinzi principale, complet incalzit

- Cuptor special pe gaz (21m x 2.5m): structura incalzita 150 minute
- Grinzile principale si secundare neprotejate; stalpii protejati pana la nivelul unui posibil tavan fals (zona de 800mm din partea superioara a stalpului, inclusiv imbinarile au ramas fara protectie)

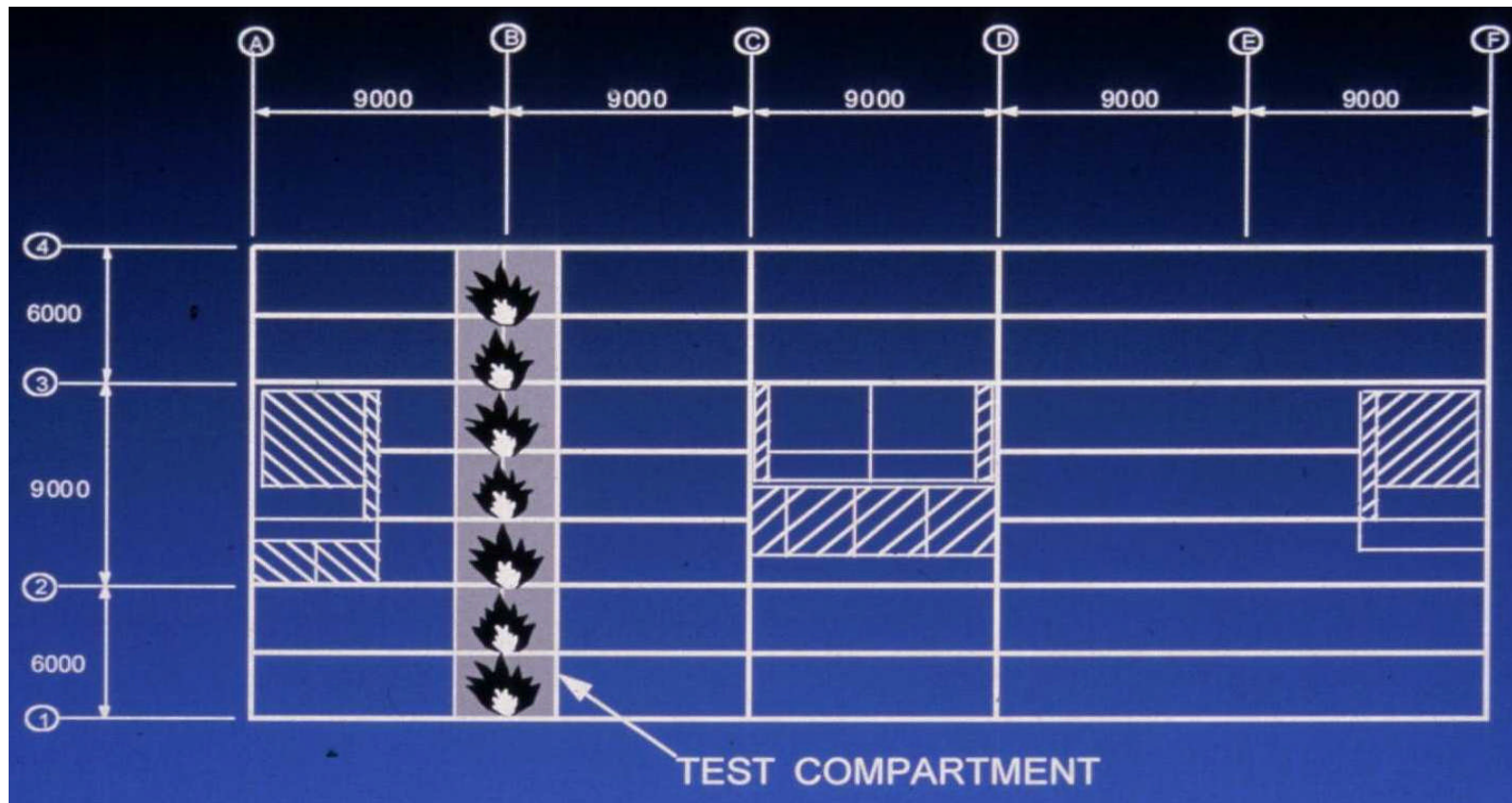

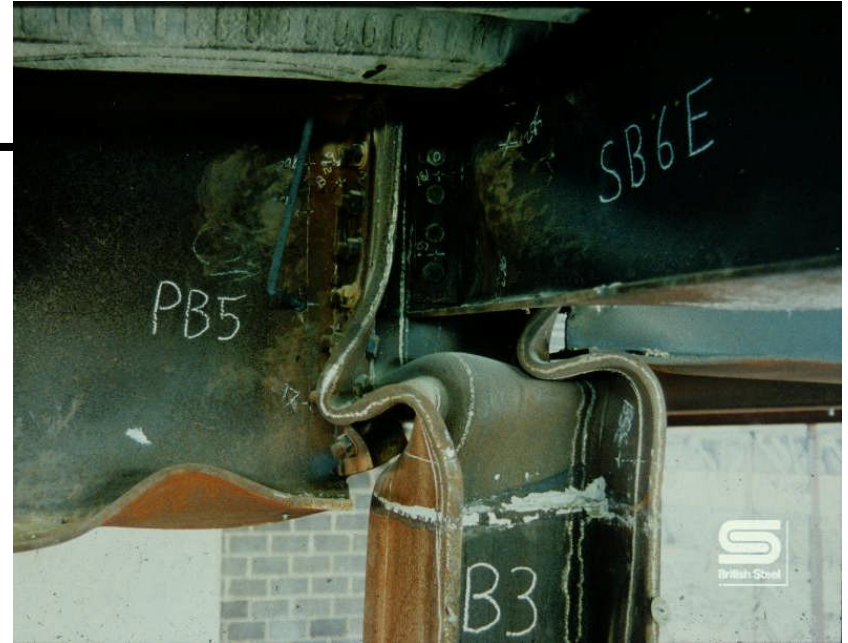

**Fara cedare la 150 minute,
desi s-a produs
voalarea zonei
neprotejate a stalpilor,
dupa 100minute**

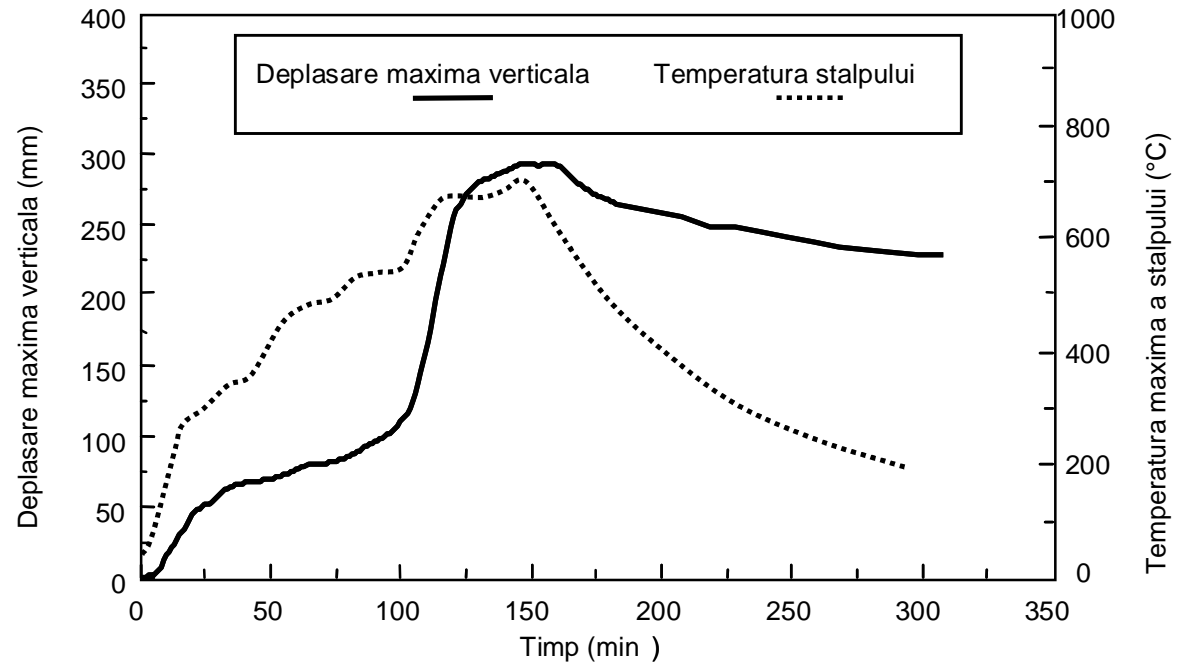



In faza de racire, cateva suruburi din imbinarile grinzilor secundare, de pe o parte a grinzii principale, au cedat

Suruburile au fost forfecate datorita contractiei termice a grinzilor secundare in timpul racirii

Contractia termica a generat forte de intindere importante, care s-au relaxat ca urmare a forfecarii suruburilor

Test 3: Compartiment in coltul cladirii (1)

Scop: investigarea posibilitatii redistribuirii eforturilor, in conditiile in care se lasa neprotejate grinzile secundare, complet expuse la foc

- Compartimentare zidarie 10m x 7.6m intr-un colt al primului etaj; sarcina termica 45kg lemn /mp distribuit pe suprafata pardoselii
- Stalpii, imbinarile grinda-stalp si grinzile marginale au fost protejate la foc; grinzile interioare au ramas neprotejate

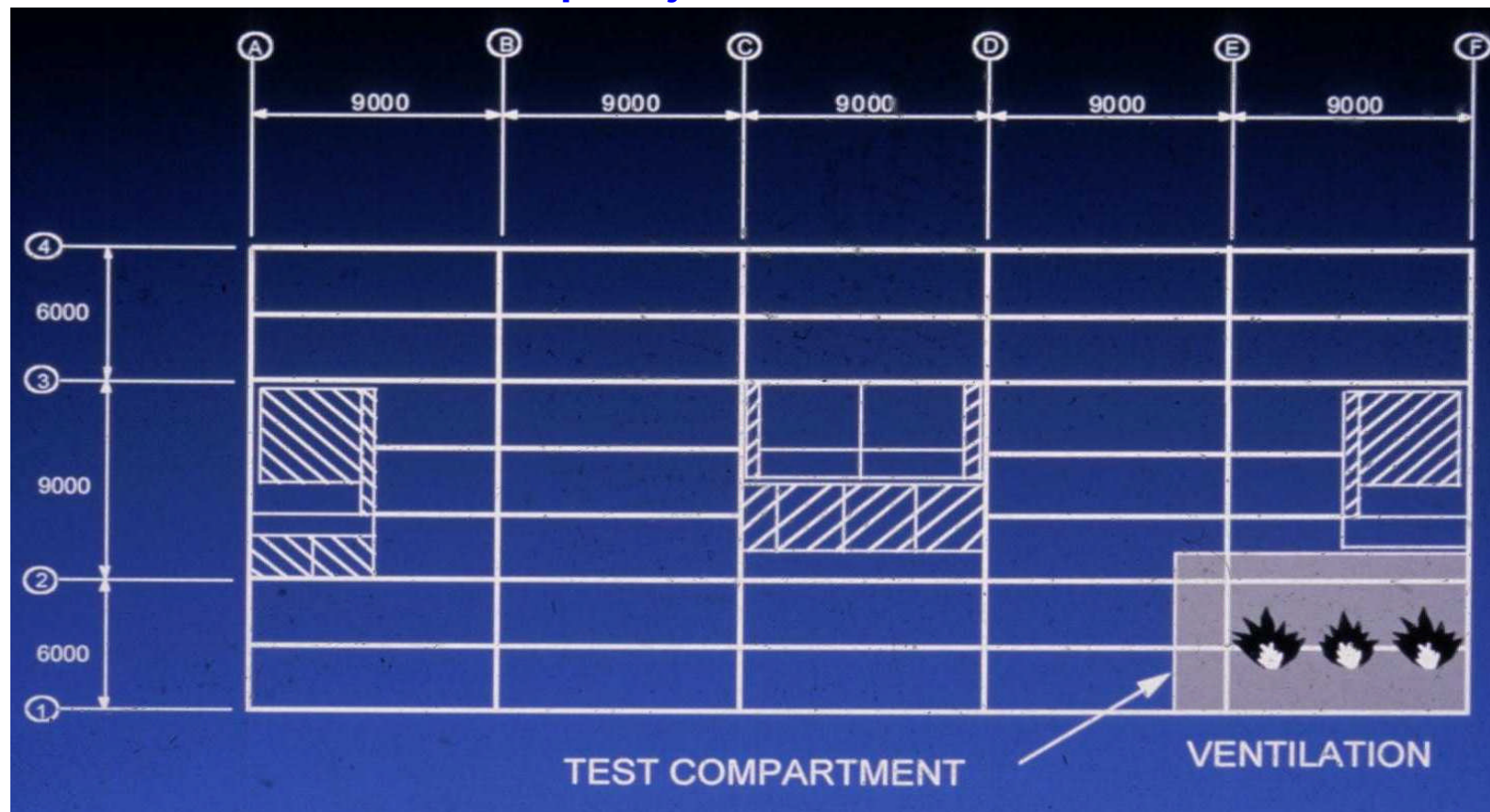



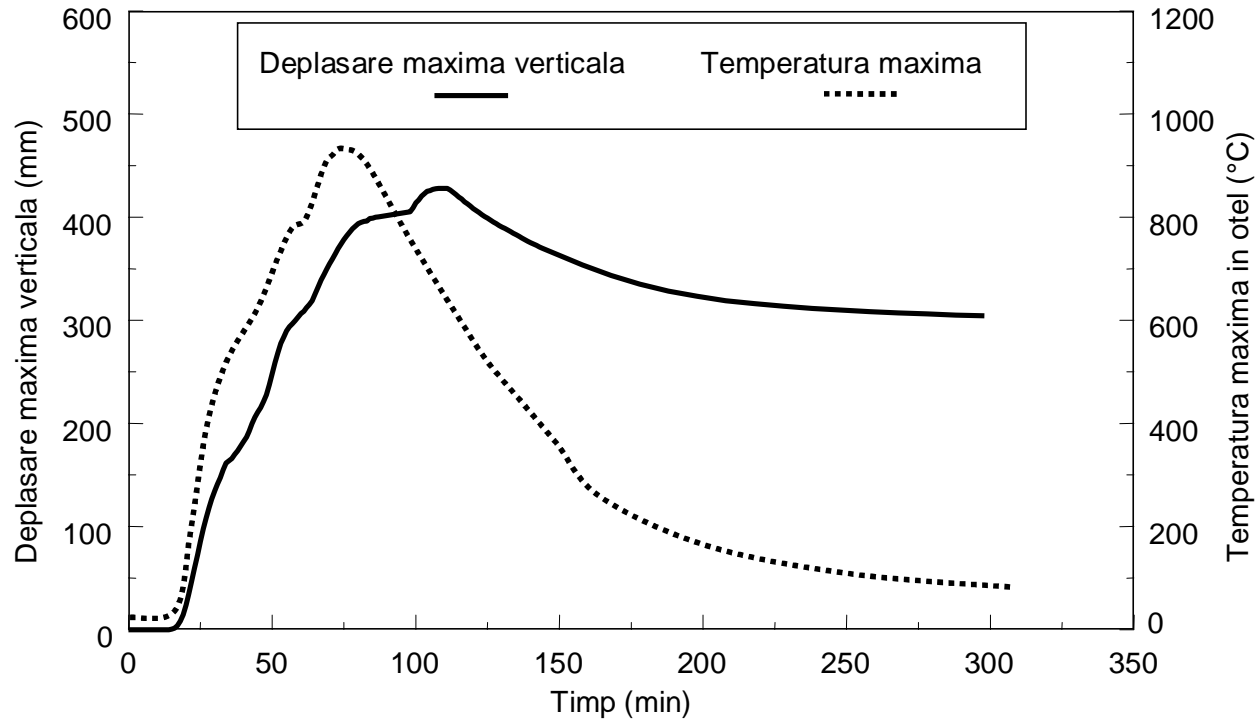

- **Fara cedare 75 minute (timp corespunzator temperaturii maxime), desi temperatura maxima in grinda a fost de 1014°C (otel la 4% din rezistenta initiala)**
- **Sageata maxima 428 mm (aproximativ L/20)**



Voalări locale au apărut în proximitatea unor îmbinări grindă-stâlp, dar, spre deosebire de Testul 2, șuruburile din îmbinare nu au cedat prin forfecare.

Test 4: Compartiment in coltul cladirii (2)

Scop: investigarea posibilitatii redistribuirii eforturilor, in conditiile in care se lasa neprotejate grinzile secundare, complet expuse la foc

- Compartimentare pe 54mp cu pereti usori REI120 intr-un colt al etajului 2; sarcina termica 40kg lemn /mp distribuit pe suprafata pardoselii
- Stalpii, imbinarile grinda-stalp si grinzile marginale au fost protejate la foc, cu exceptia grinzii marginale exterioare E4/F4; grinzile interioare neprotejate

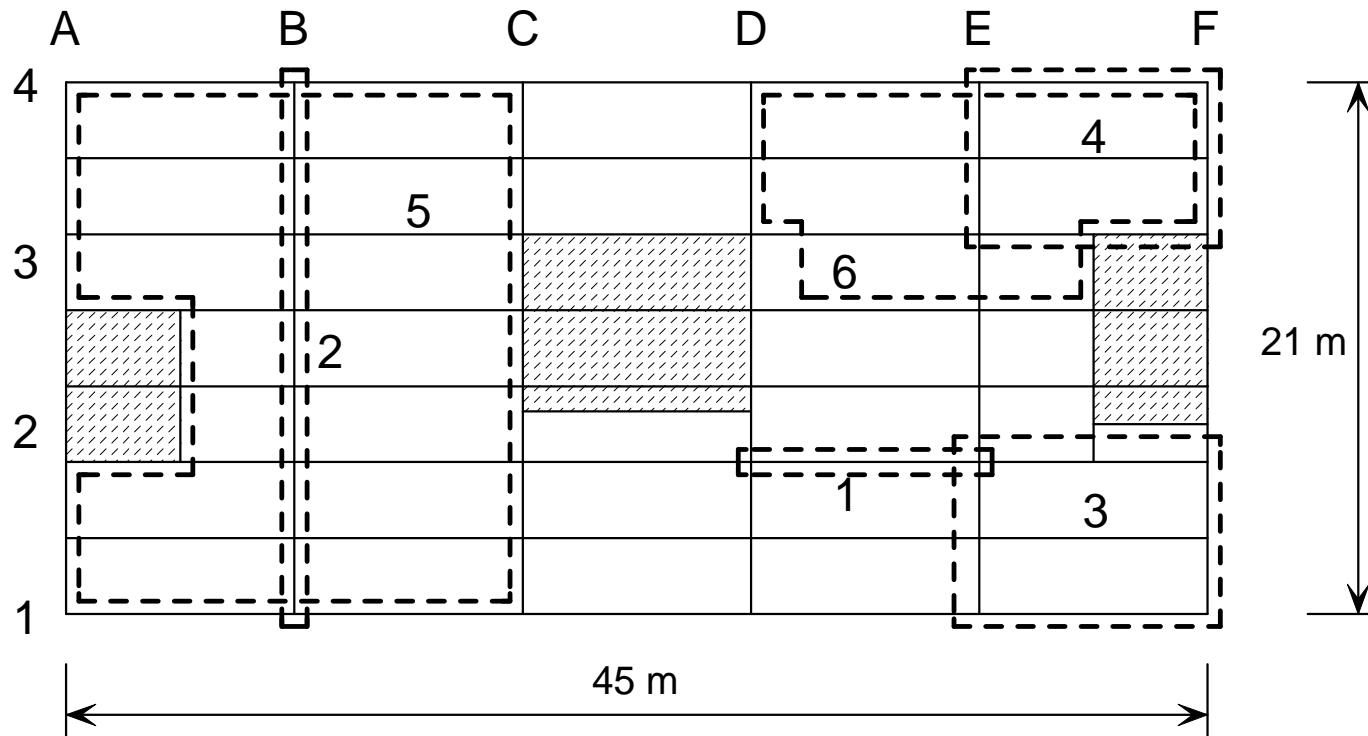

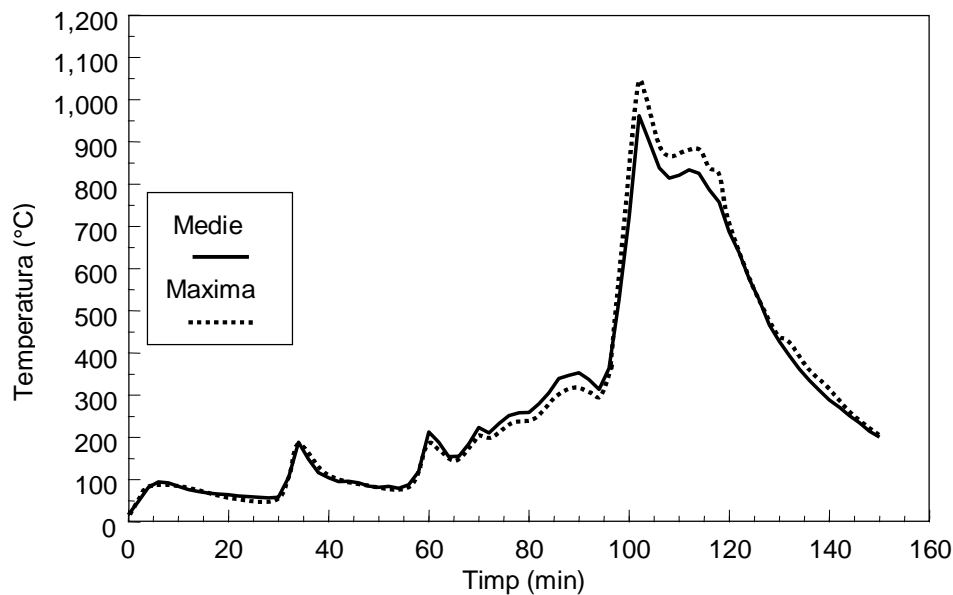

Compartimentul a fost complet închis, cu toate ușile și ferestrele închise. Pentru aportul de aer, după 55 și 64 minute, s-a demontat câte un panou de fereastră. Intre 94 și 100 minute toate ferestrele au fost distruse. Temperatura maxima a gazelor fierbinti a fost de 1051°C după 102 minute.

Temperatura maxima a oțelului a fost de 903°C, în talpa inferioară a grinzii secundare centrale. Grinda de capăt a avut temperaturi relativ reduse.

Nici una din grinzi nu a prezentat voalari locale și nu au existat cedări locale în îmbinări.

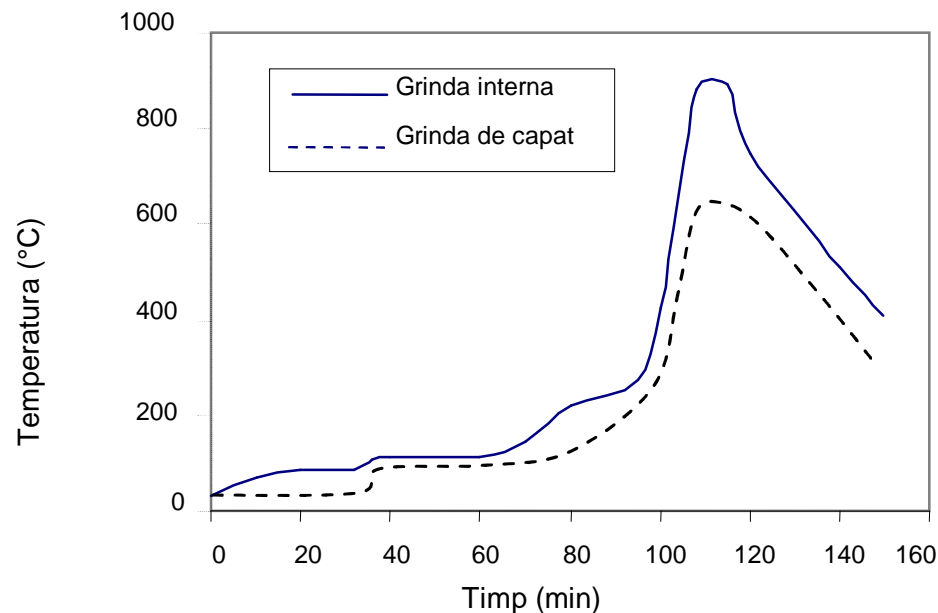

Test 5: Compartiment interior (1)

Scop: investigarea posibilitatii redistribuirii eforturilor, in conditiile in care se lasa neprotejate toate grinzile

- Compartimentare pe 340mp cu pereti usori REI120 pe toata latimea cladirii; sarcina termica 40kg lemn /mp distribuit pe suprafata pardoselii
- Stalpii interiori si exteriori protejati pe toata inaltimea, inclusiv imbinarile; toate grinzile, inclusiv cele marginale au ramas neprotejate

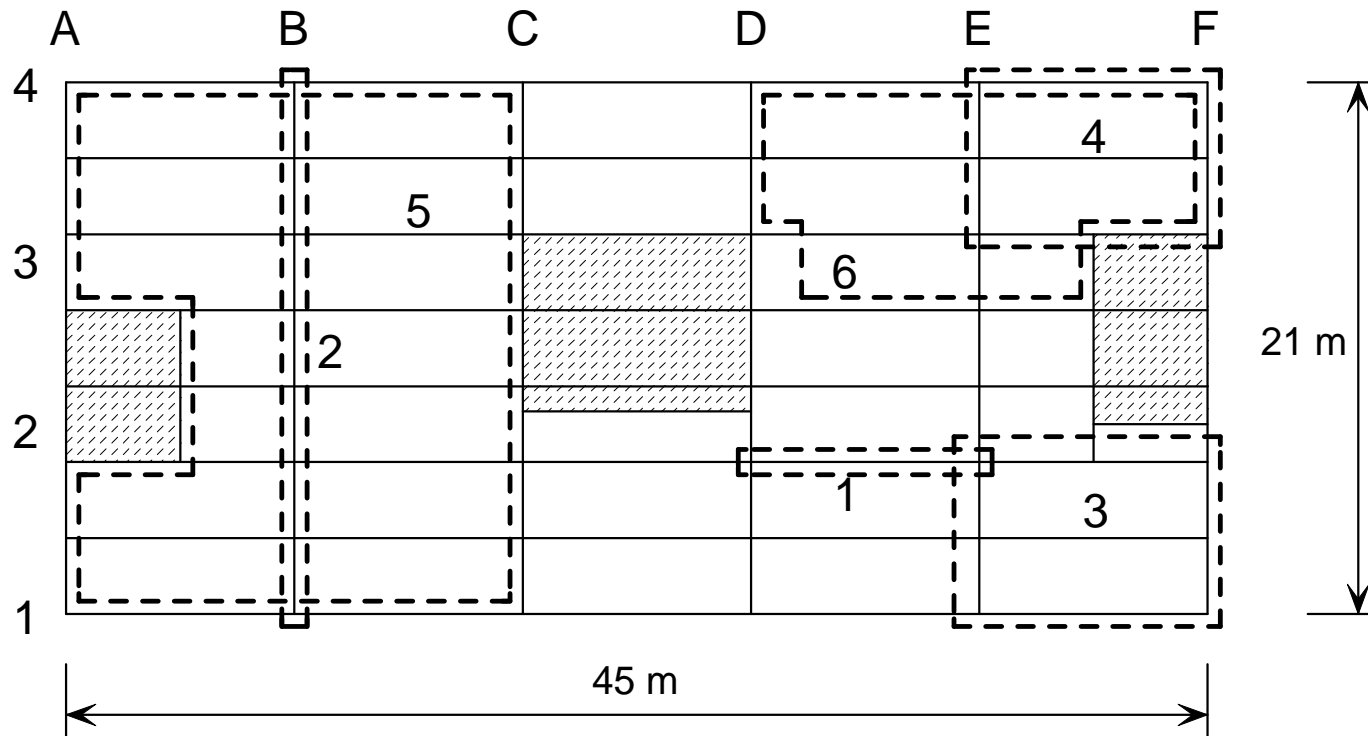

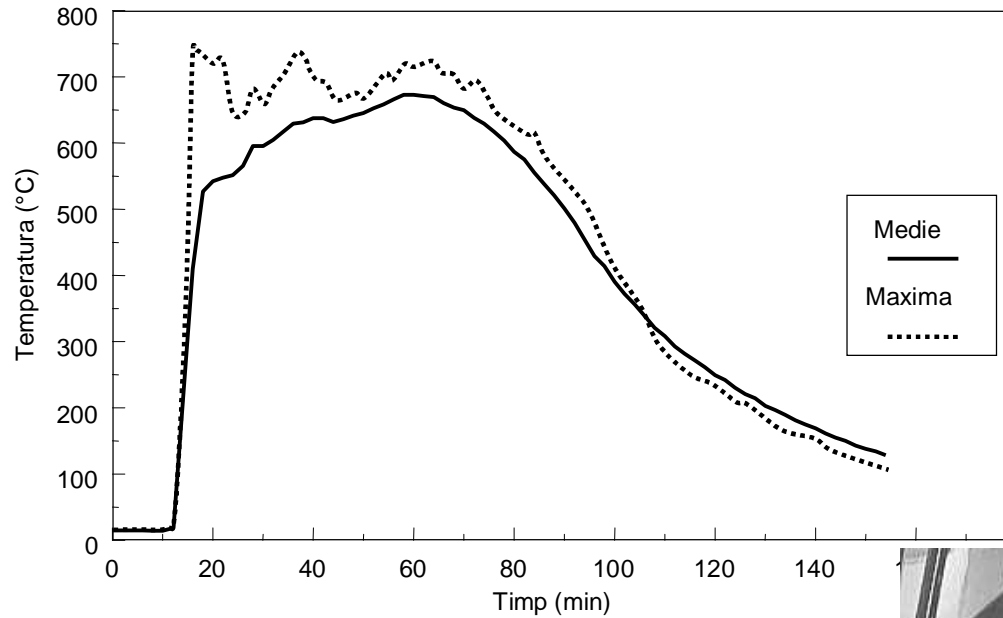

Temperatura maxima a gazelor fierbinti a fost 746°C iar temperatura maxima in otel a fost 691°C.

Sageata maxima a planseului - 557mm.

Fara cedare, chiar daca au aparut voalari locale si fisuri in imbinari.



Test 6: Compartiment interior (2)

Scop: evaluarea comportarii structurii intr-un scenariu real de incendiu

- Compartimentare pe 154mp cu pereti zidarie intr-un colt al etajului 2; suprafata deschideri limitata la minimul permis; sarcina termica provenita din mobilare obisnuita pentru birouri, echivalent 46kg lemn /mp;
- Stalpii si imbinarile grinda-stalp cu protectie foc; toate grinzile principale si secundare, inclusiv imbinarile intre acestea, au ramas neprotejate

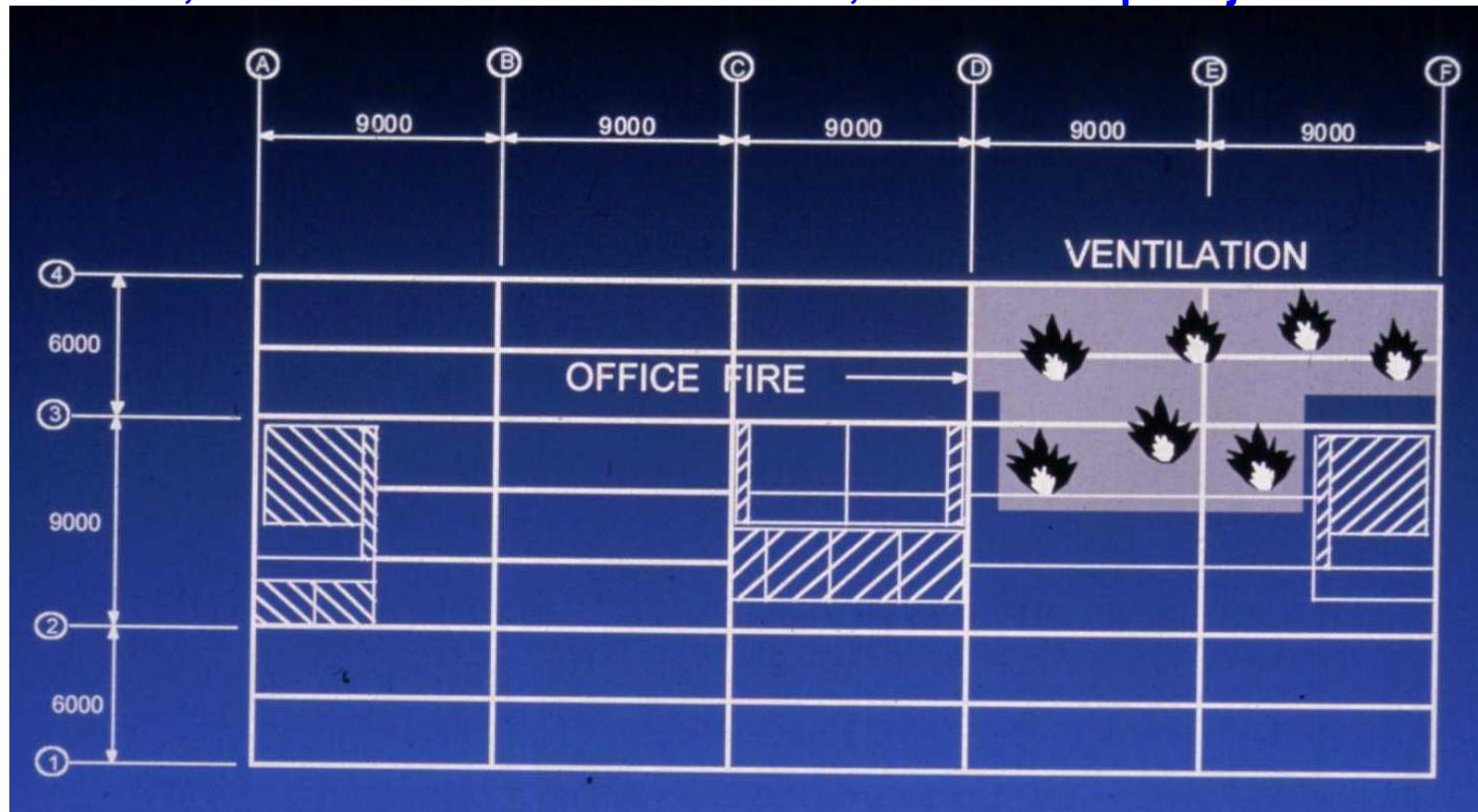



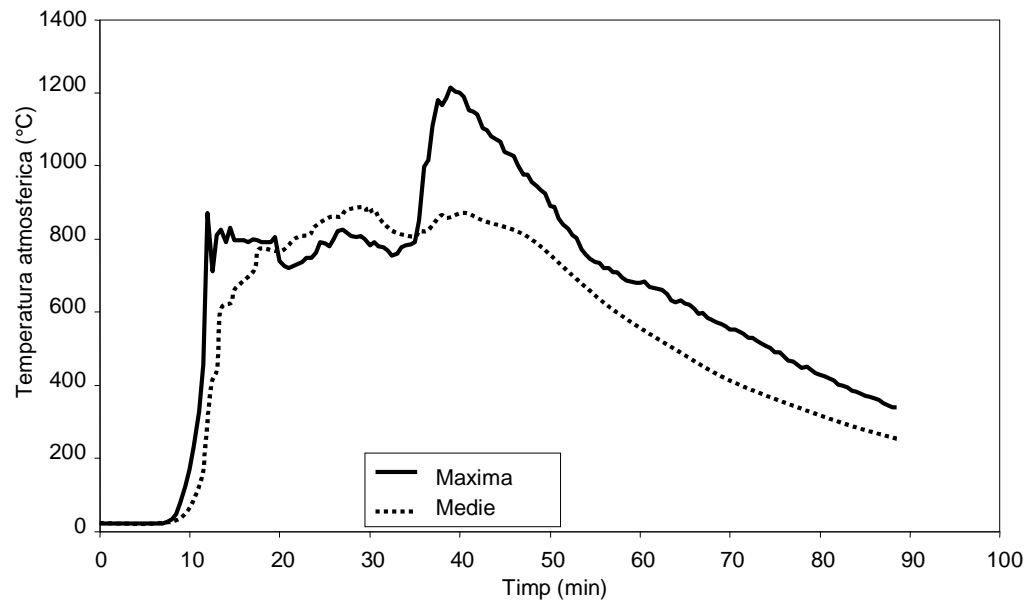

Fara cedare, desi s-au produs deplasari verticale importante (sageata maxima 640mm)

Temperatura maxima gaze fierbinti - 1213 °C

Temperatura maxima otel - 1150°C

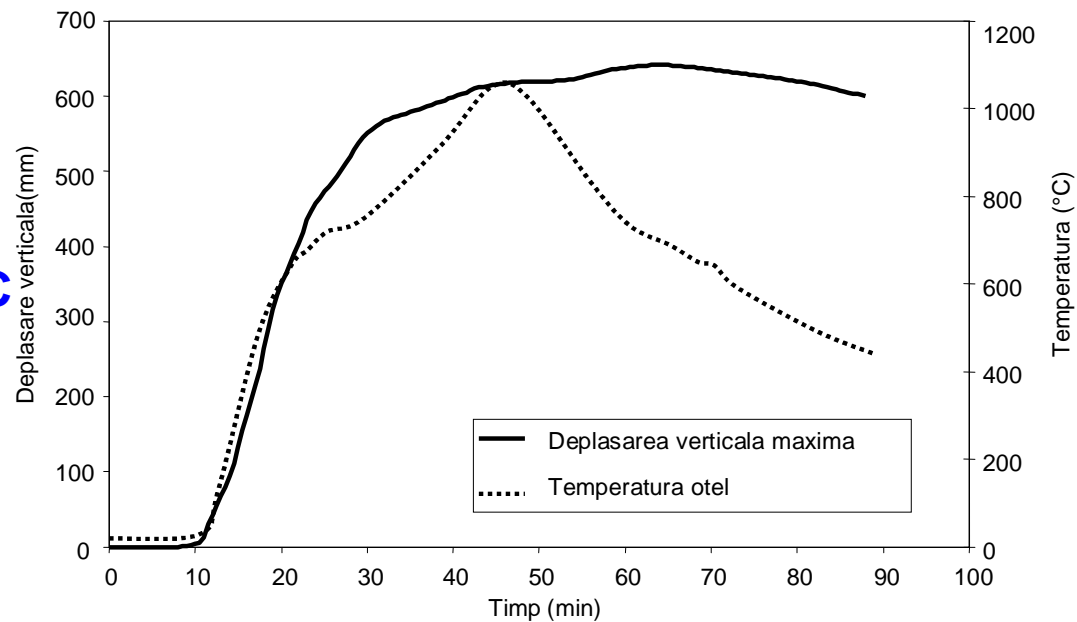



**Structura nu a prezentat
semne de cedare, doar
voalari locale ale grinzilor
in zona imbinarilor.**



-
- **Concluzii in urma testelor efectuate la Cardington pe cladirea cu structura compusa otel-beton**
 - **In nici unul din testele la foc efectuate nu s-a produs colapsul structurii;**
 - **Comportare globala corespunzatoare a planseului compus, chiar in conditiile incalzirii grinzilor din otel la peste 1000°C;**
 - **Robustete mare a sistemului structural prin redistribuirea eforturilor;**
 - **Comportare la foc mai buna a elementelor in structura, fata de situatia considerarii elementelor izolate.**

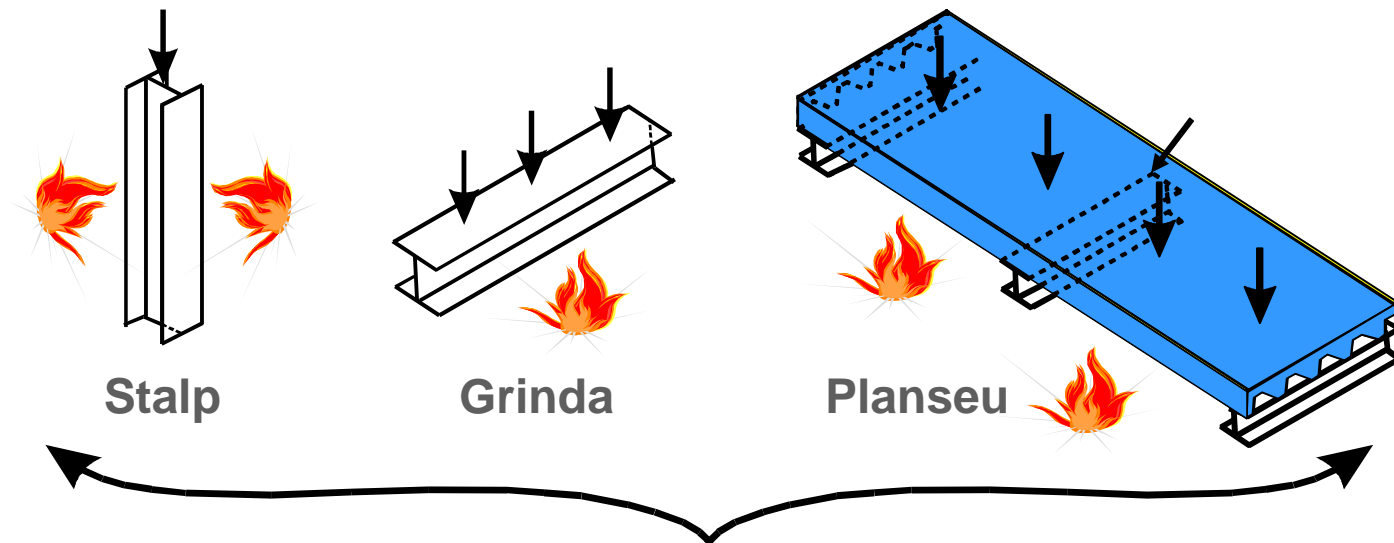

Metoda uzuala de proiectare la foc considera ca elementele considerate izolat (analiza pe elemente) au un comportament similar in structura

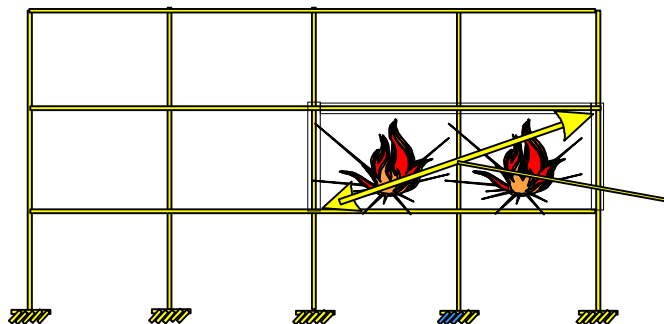

Comportamentul real al planseelor compuse

Cresterea temperaturii in timpul incendiului

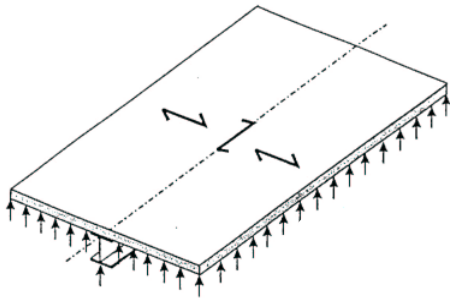

(a)

Incovoiere

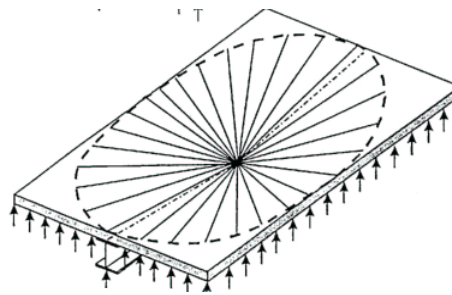

(b)

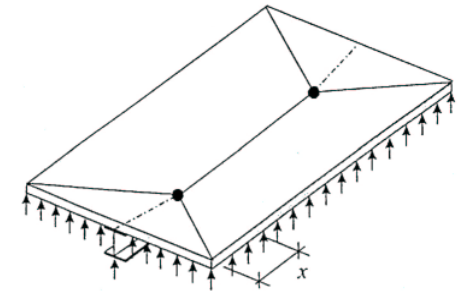

(c)

Efect membrana



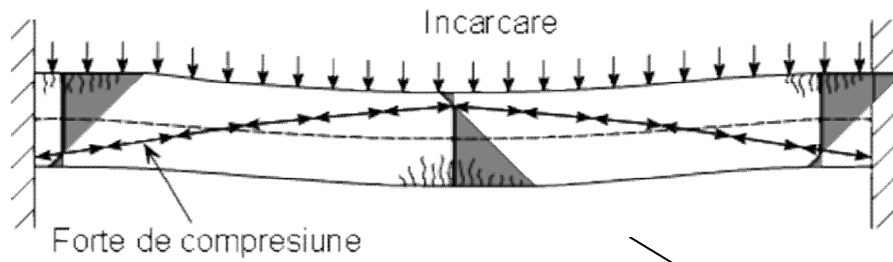

Efect de membrana

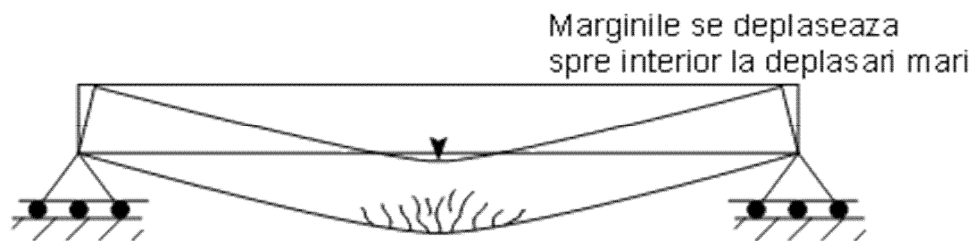
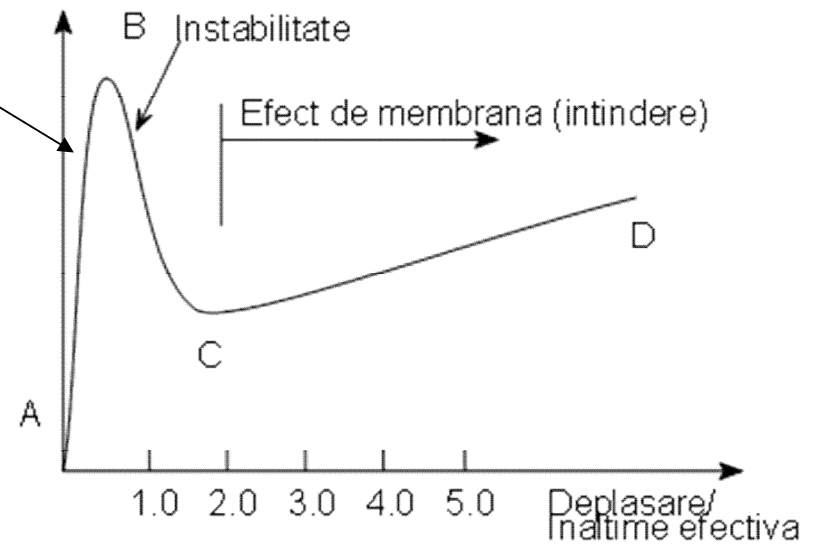

Fara efect de membrana

Efect de membrana

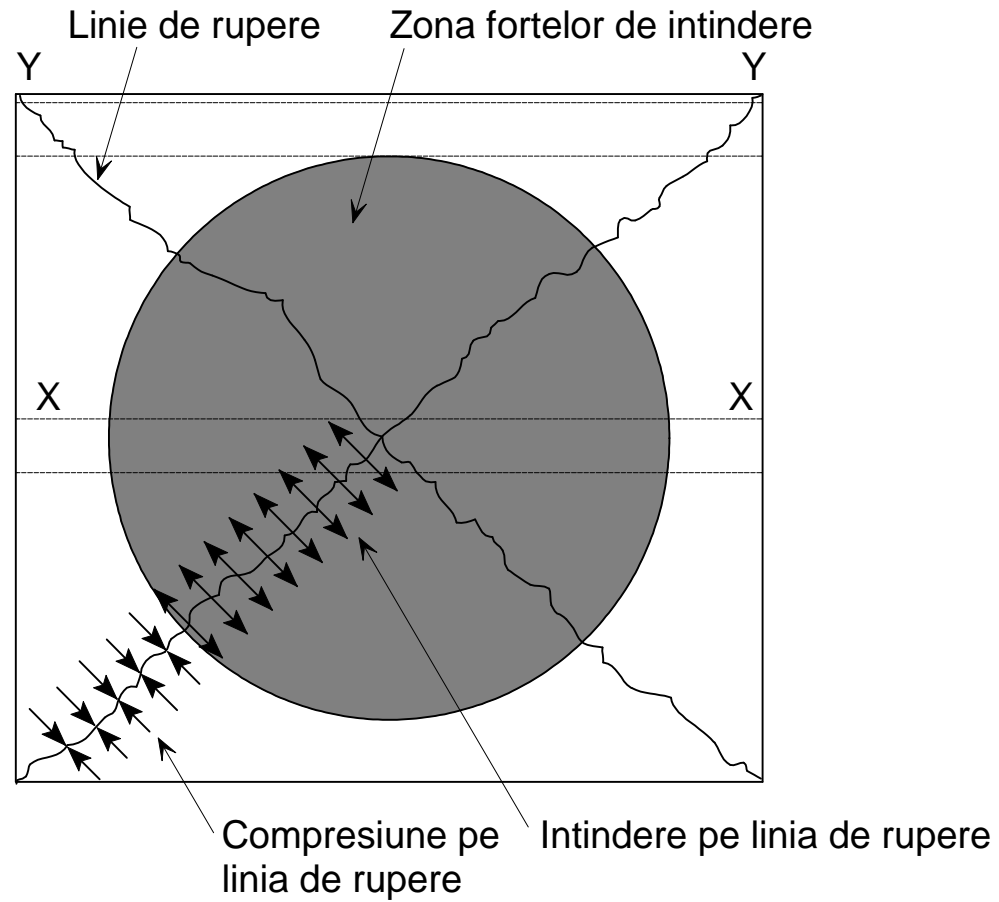

PROGRAM DE INCERCARI LA FOC PE O PARCARE DESCHISA – CTICM FRANTA

Scop: evaluarea comportarii unei structuri compuse otel-beton pentru parcare deschisa, intr-un scenariu real de incendiu

- 3 teste: primele doua au inclus 3 masini incendiate, al treilea a analizat raspandirea focului intre 2 masini asezate fata in fata
- Stalpi si grinzi din otel fara protectie la foc

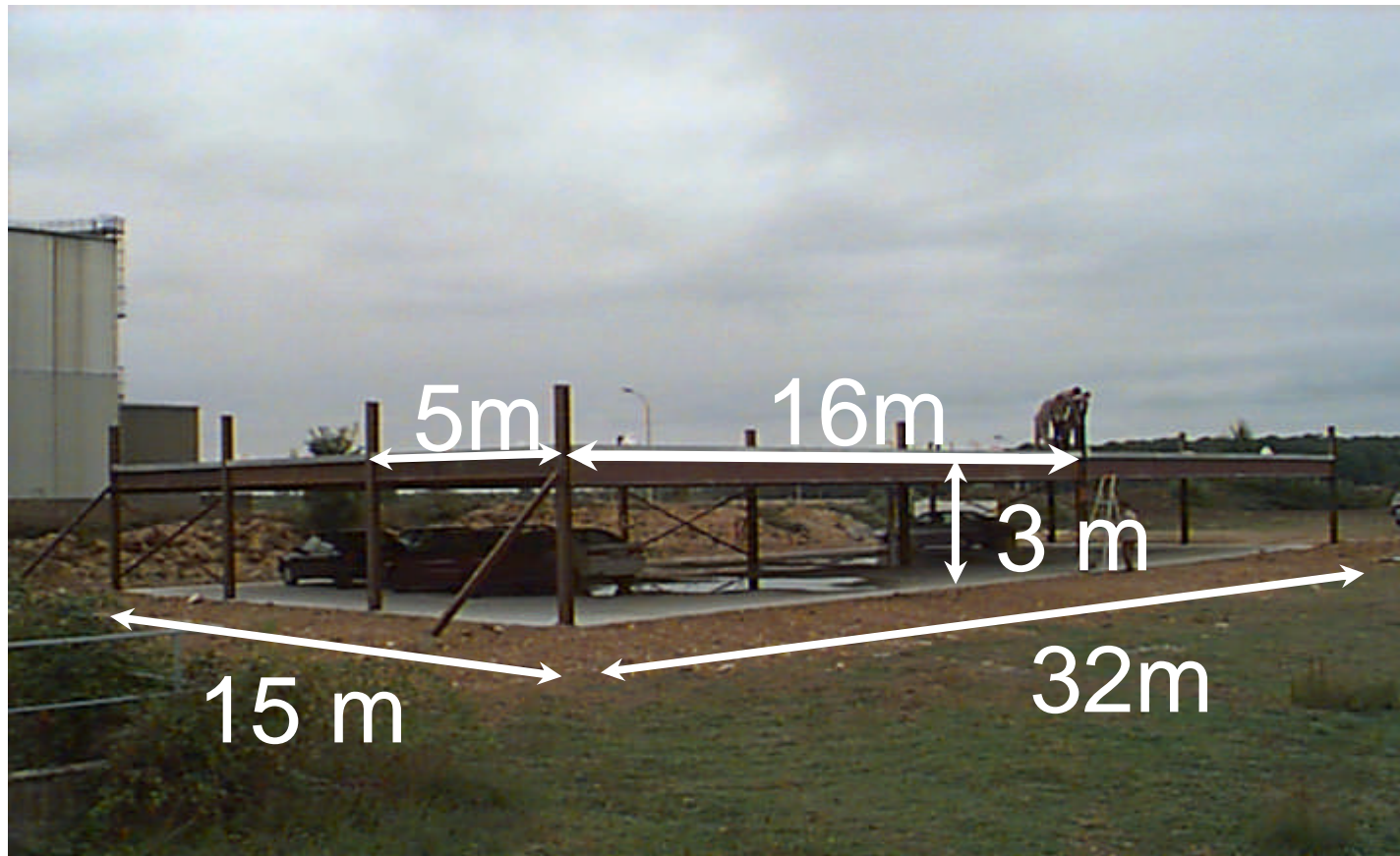

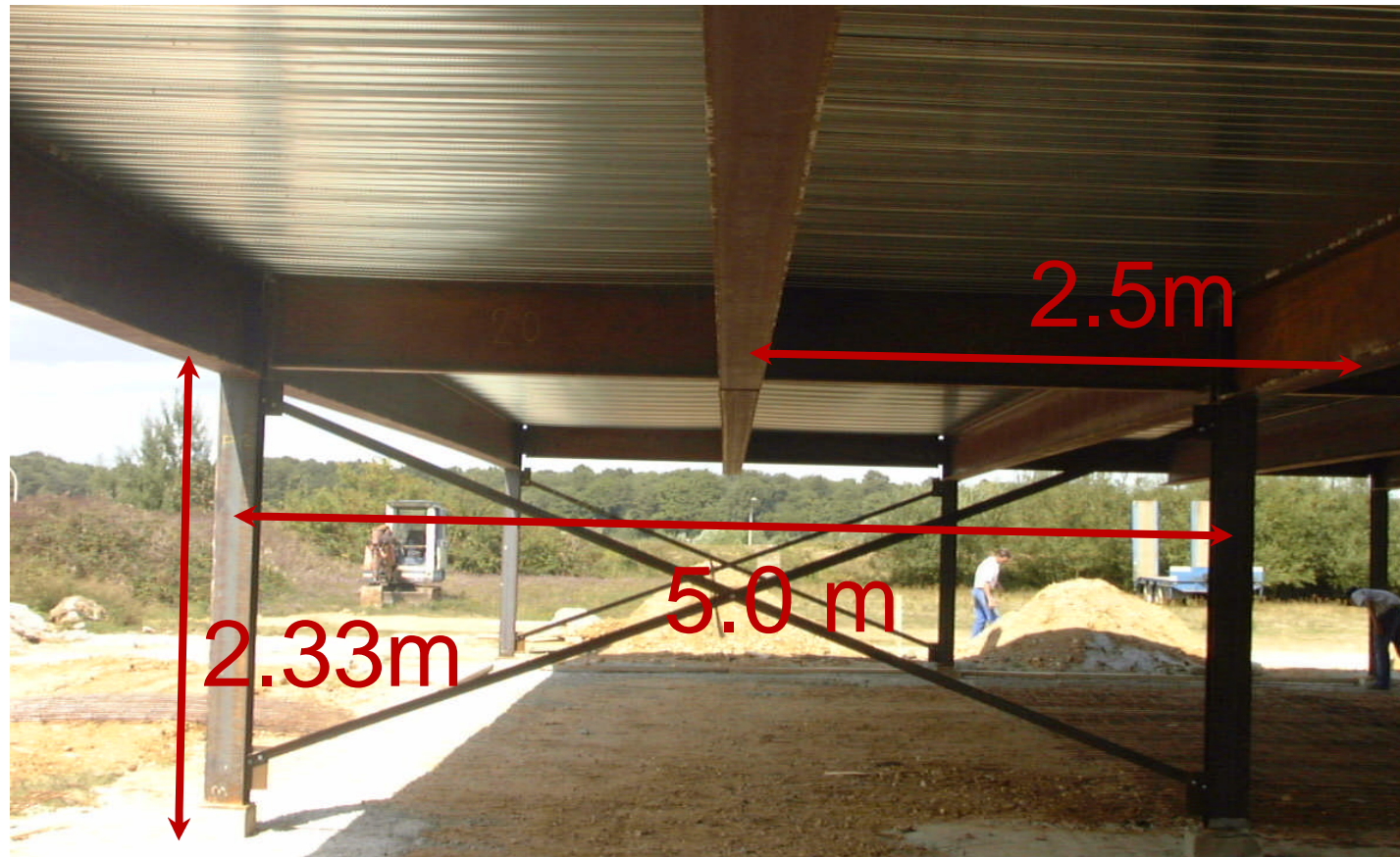

0 min



Test 1



Test 2

10 min



Test 1



Test 2

Test 1



33 min



62 min

Test 2



25 min



44 min

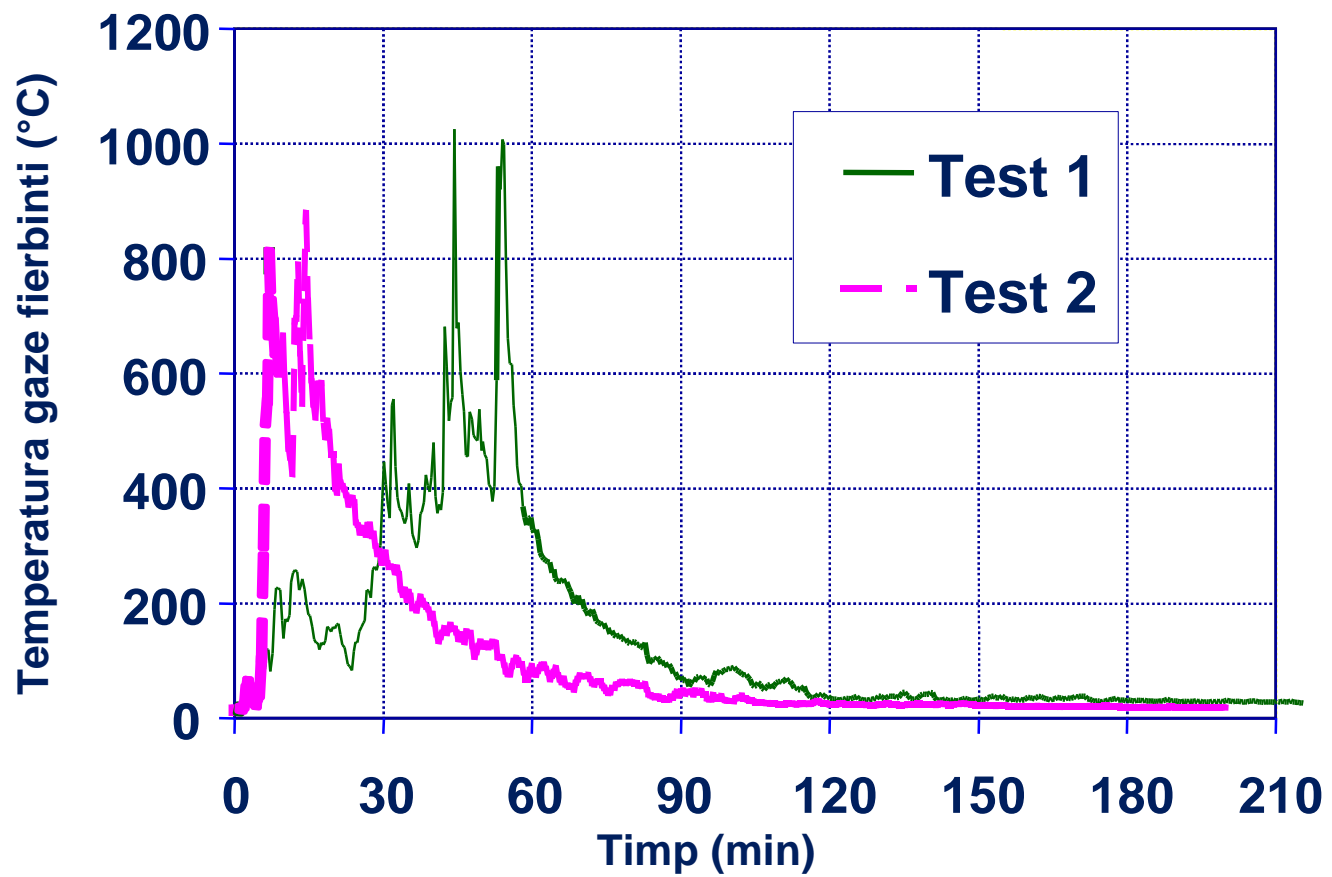

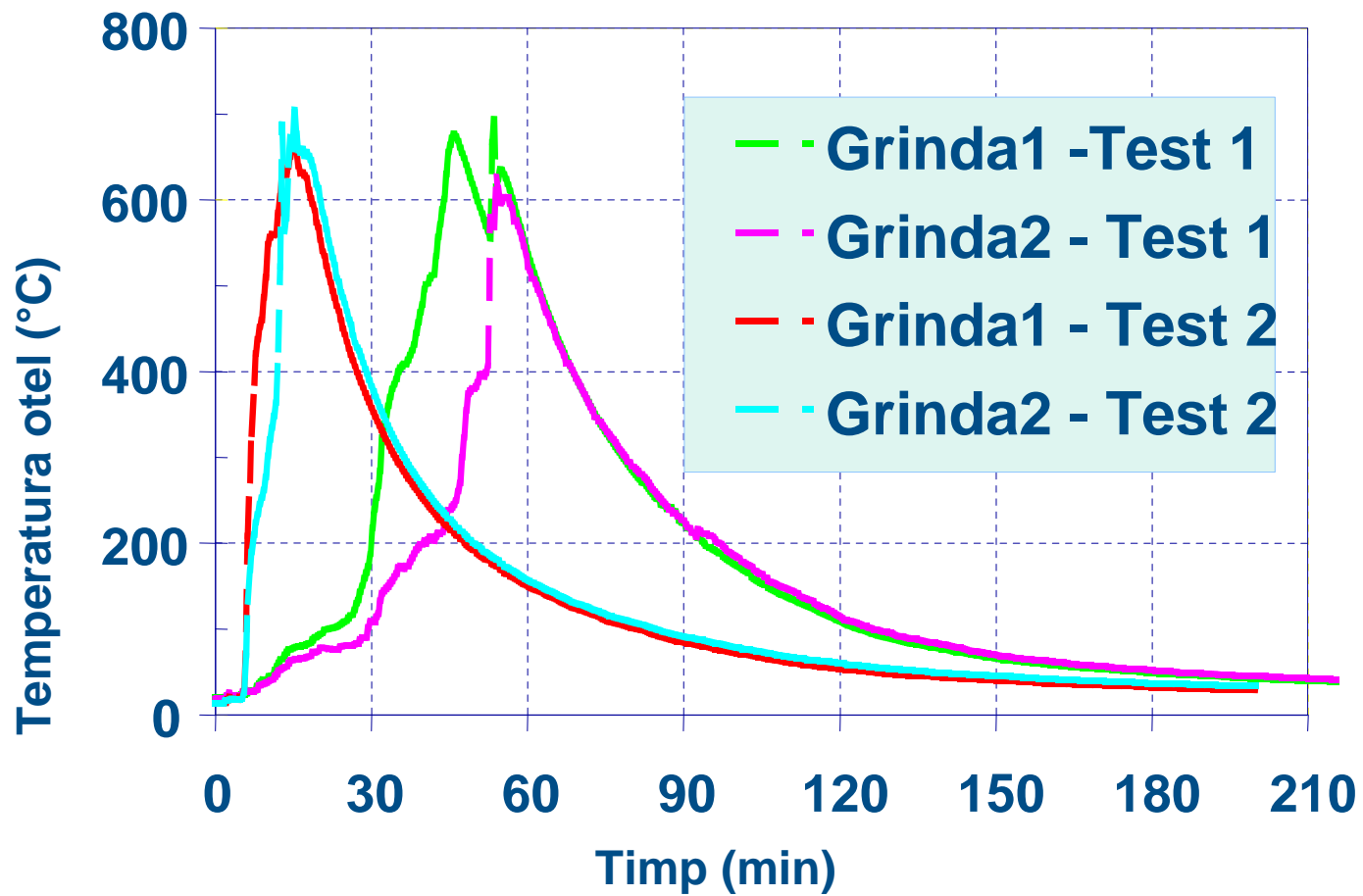

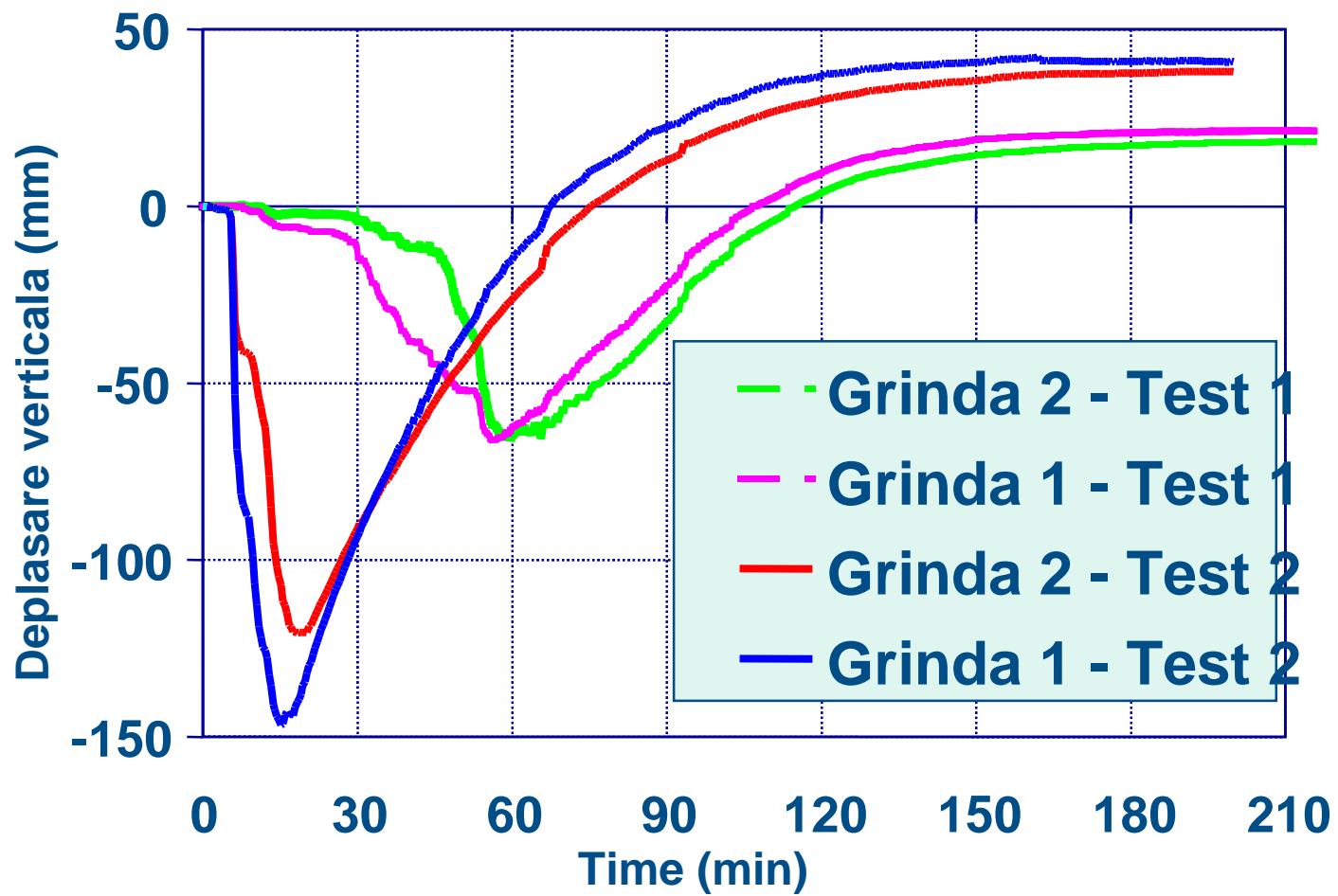

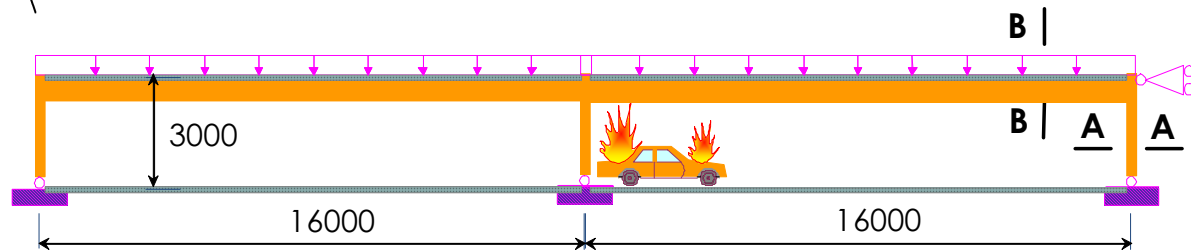
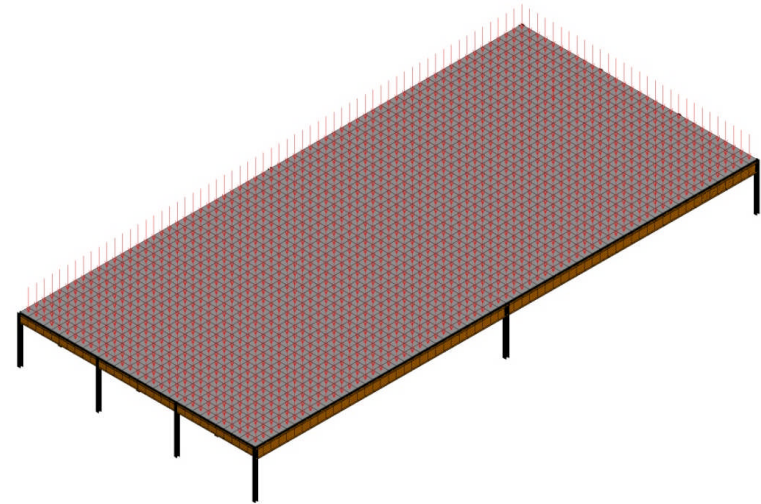
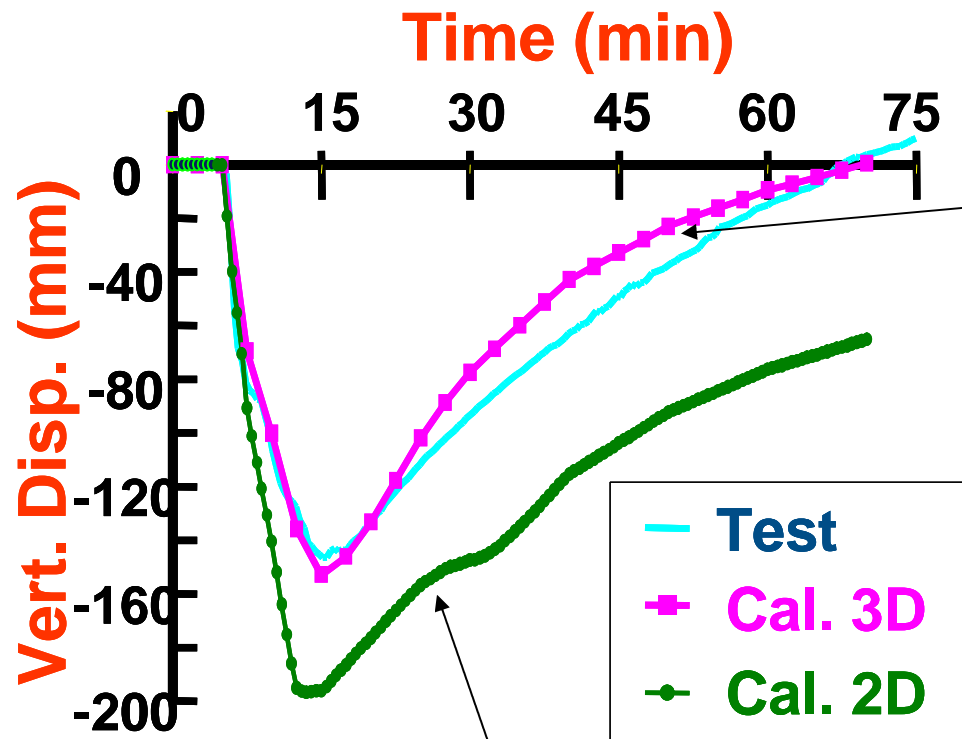

INCENDIUL DIN CLADIREA BROADGATE – LONDRA, 1990

Cladire birouri P+14E, in constructie, sistemul de masuri active contra incendiului nu era operational

Incendiul a inceput din interiorul unei baraci amplasate la etajul I

Grinzi I, grinzi cu zabrele, in conlucrare cu planseul de beton, fara protectie la foc

Stalpi partial protejati

Temperaturile maxime ale gazelor fierbinti estimate la 1000°C; temperatura maxima a elementelor de otel neprotejate nu a depasit 600°C

Fara cedare, desi planseul a suferit deplasari importante (peste 600mm)



INCERCARI LA FOC PE PLANSEE COMPUSE LA SCARA REALA SUB FOC ISO

Metoda de calcul a planșeelor compuse ținând cont de efectul de membrană a fost realizată în principal pe baza încercărilor la foc natural.

Conceptul de proiectare poate fi de asemenea aplicat folosind curba standard temperatură – timp.

Câteva aspecte necesită investigații suplimentare, precum:

- incendiile de lunga durată (90 - 120 minute);**
- diverse detalii de execuție.**

In acest scop au fost realizate doua programe experimentale, in cadrul proiectelor europene FRACOF si COSSFIRE, finantate de Comisia Europeana prin RFCS

Specimene experimentale

- FRACOF (proiectat REI120)

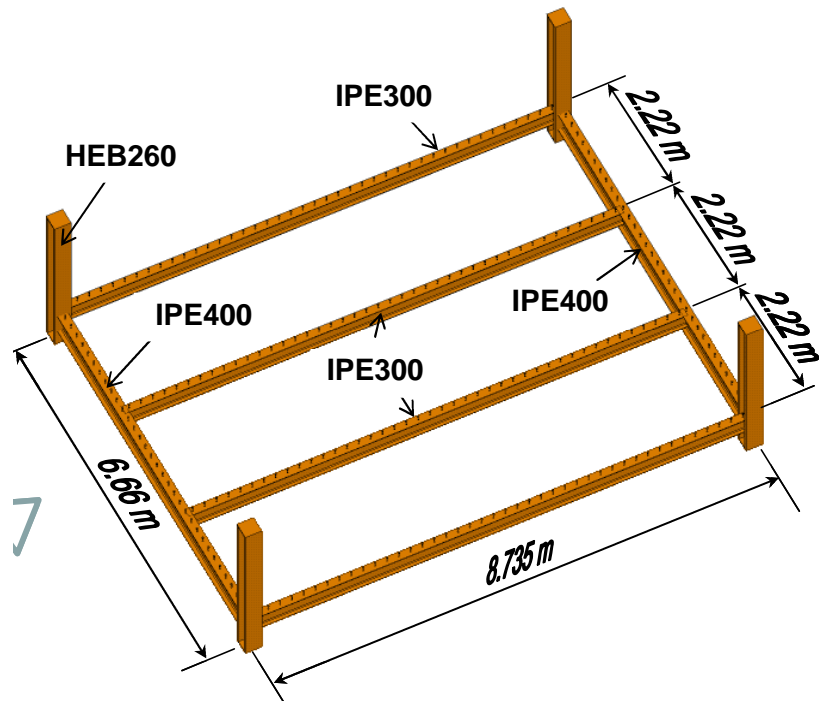

- COSSFIRE (proiectat REI90)

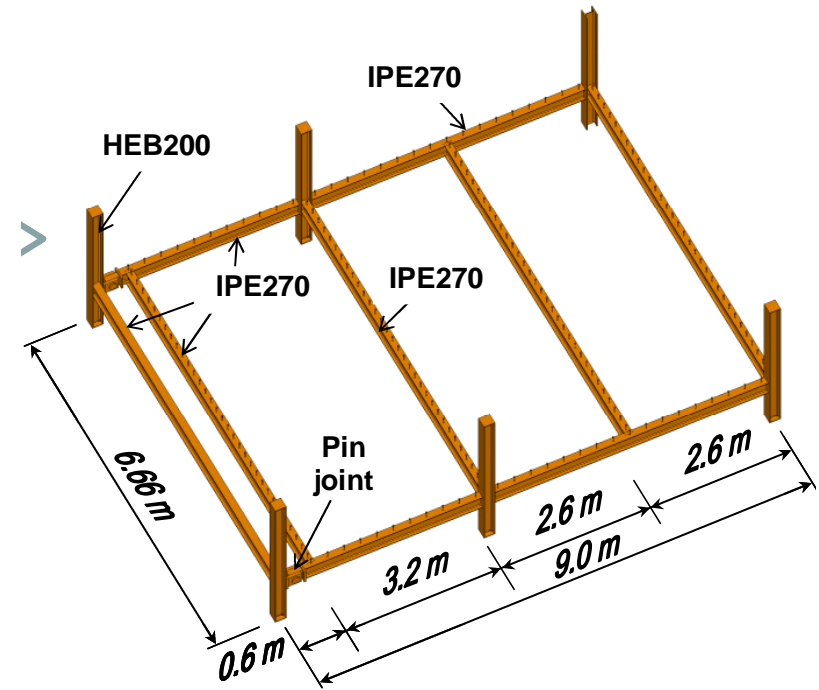

FRACOF

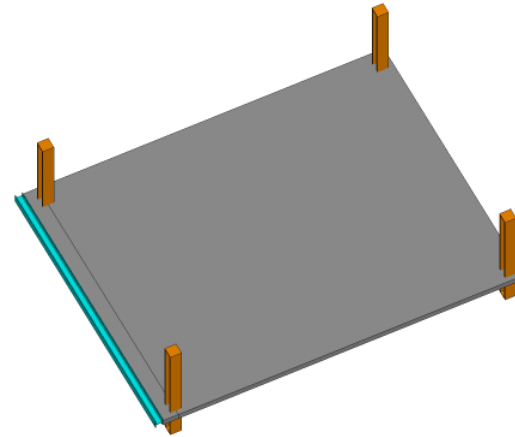
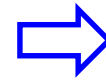
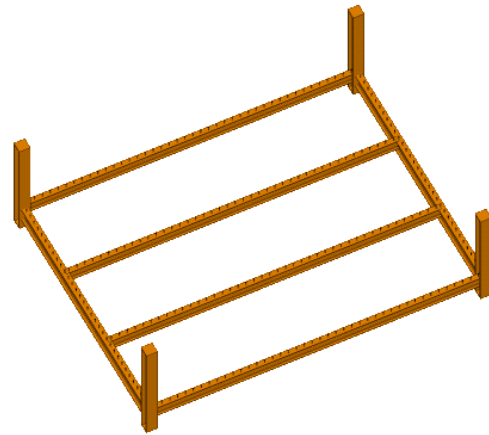

COSSFIRE

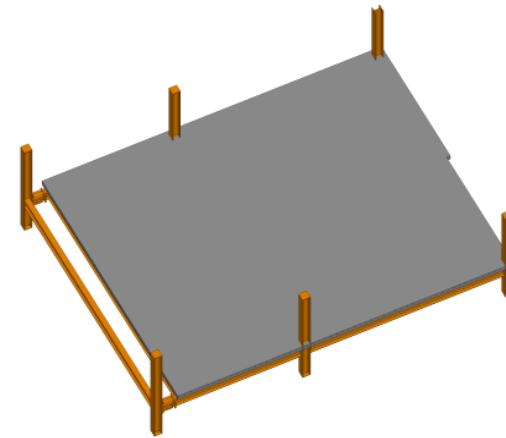
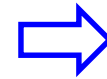
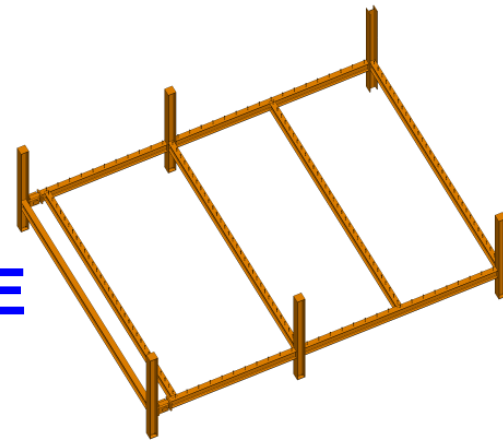

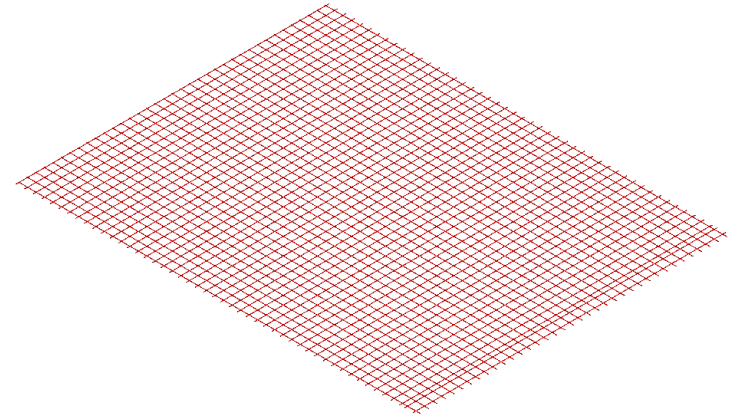
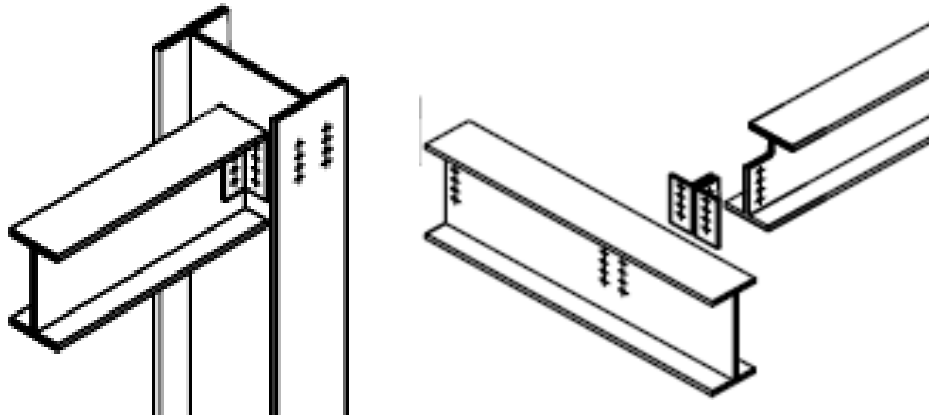

Plasa armatura

150x150mm

Diametru: 7 mm

Otel: S500

Distanța de la partea
superioară a
planșei:

- 50 mm FRACOF
- 35 mm COSSFIRE



Tabla cutată: COFRAPLUS60 – 0.75 mm

Beton: C30/37

Incarcare

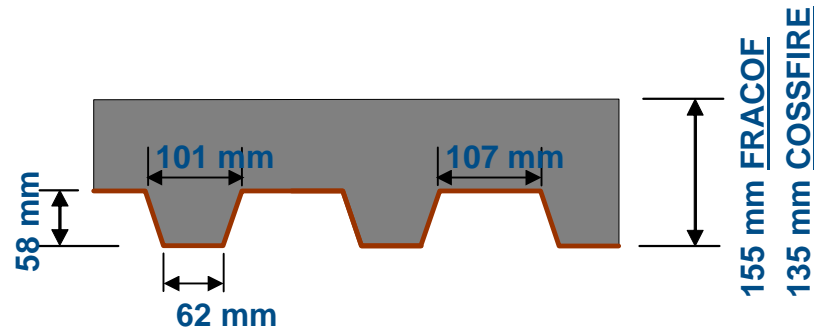
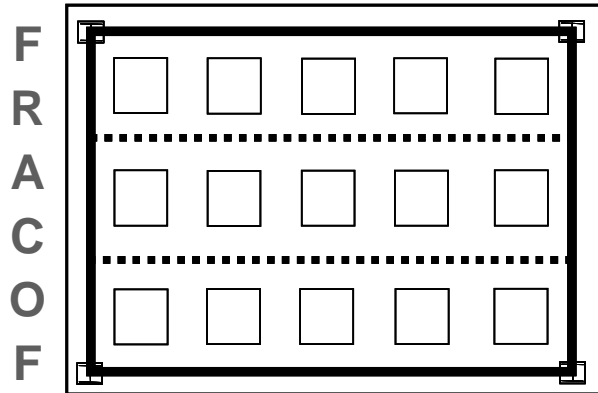

**15 saci nisip
de 1512 kg
Incarcare
uniforma
echivalenta:
390 kg/m²**

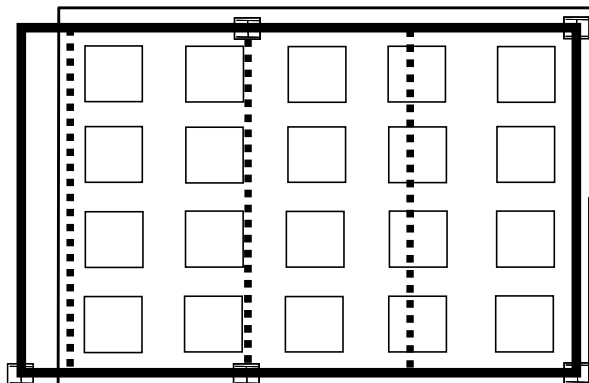

COSSFIRE



**20 saci nisip
de 1098 kg
Incarcare
uniforma
echivalenta :
393 kg/m²**

Pregatirea testului FRACOF

1



2



3



4



Evolutia temperaturii gazelor fierbinti

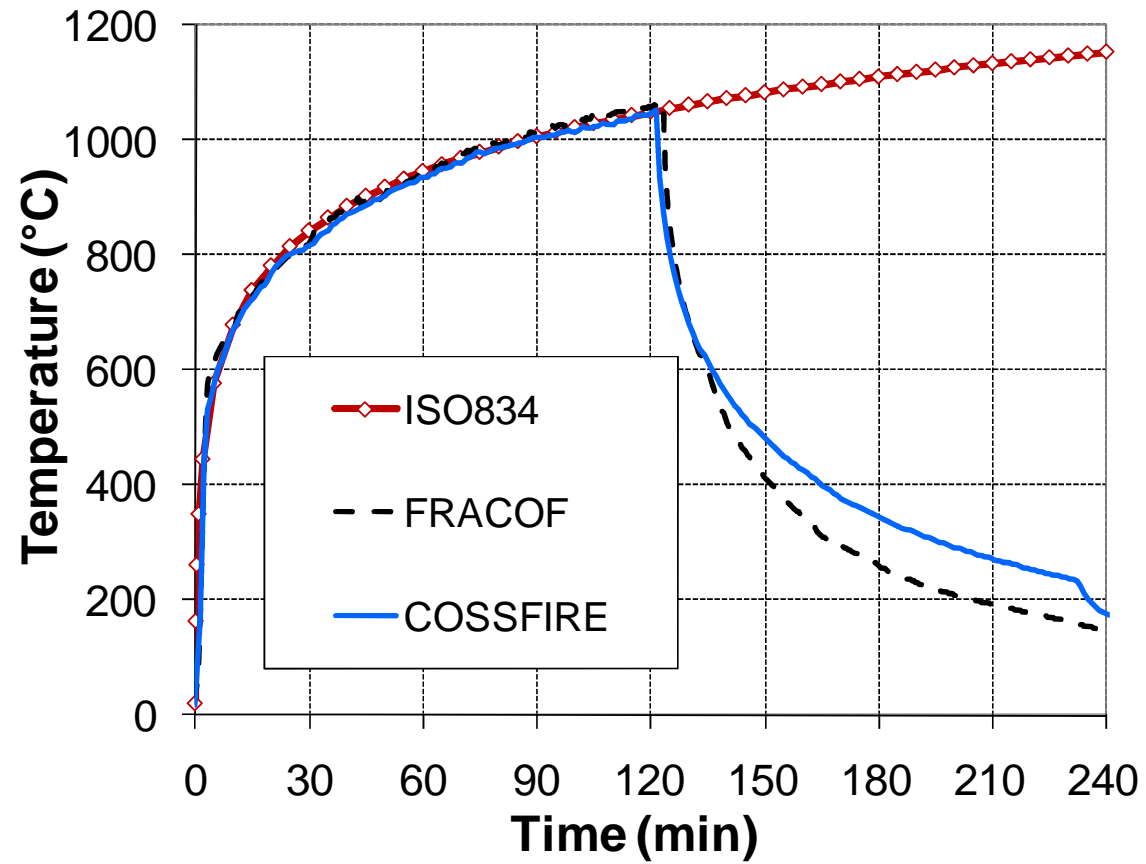

Evolutia temperaturii in grinzile neprotejate

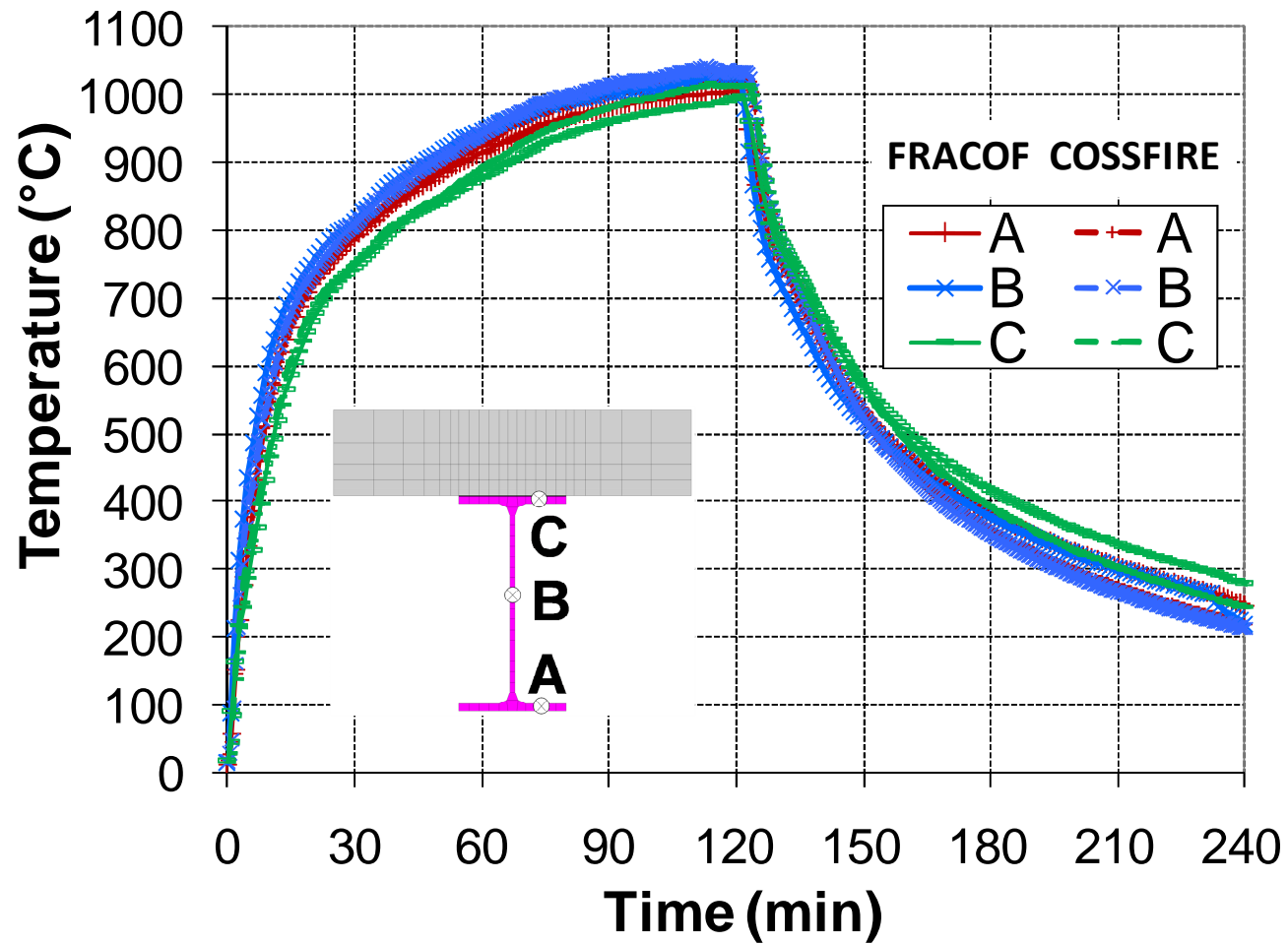

Evolutia temperaturii in grinzile protejate

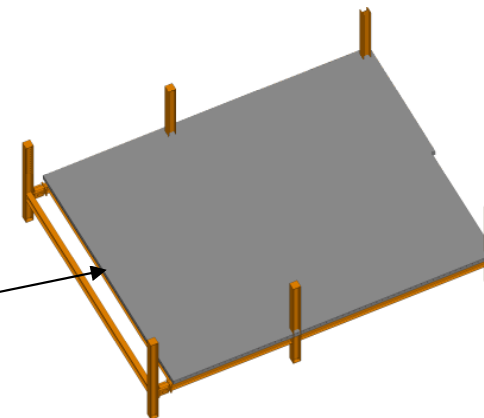
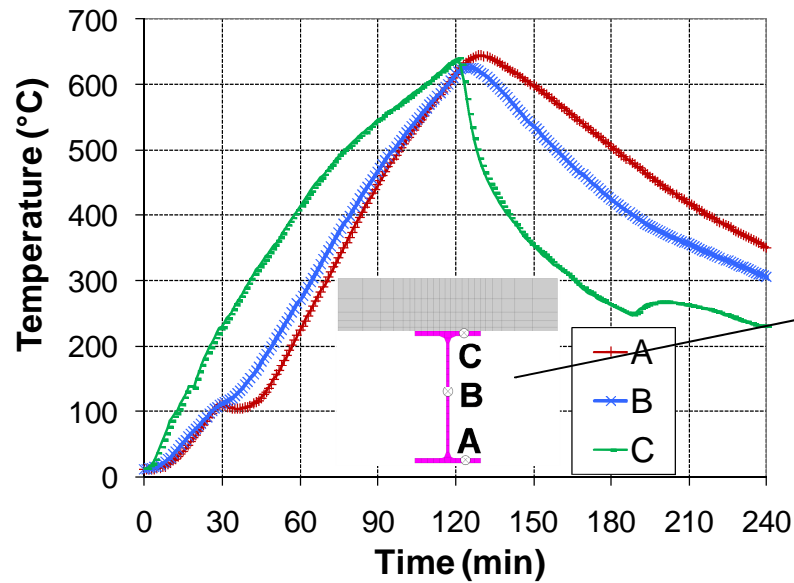
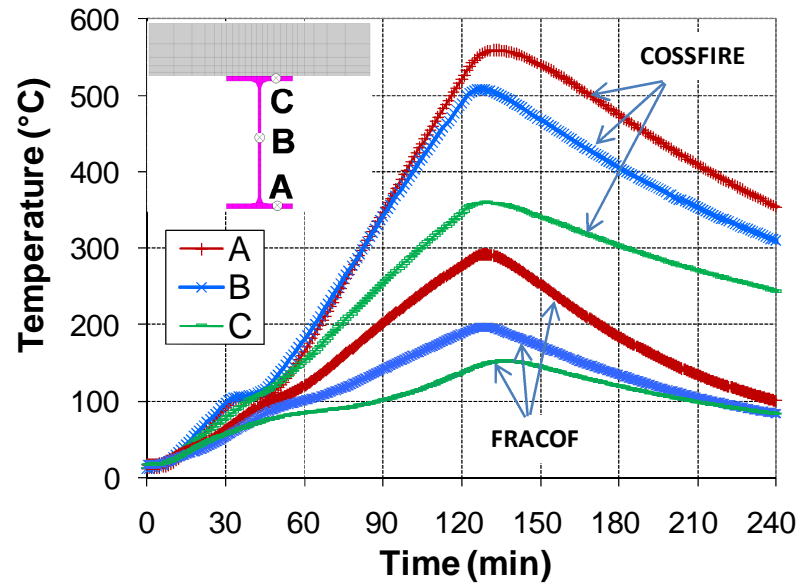

Evolutia temperaturii in planseu

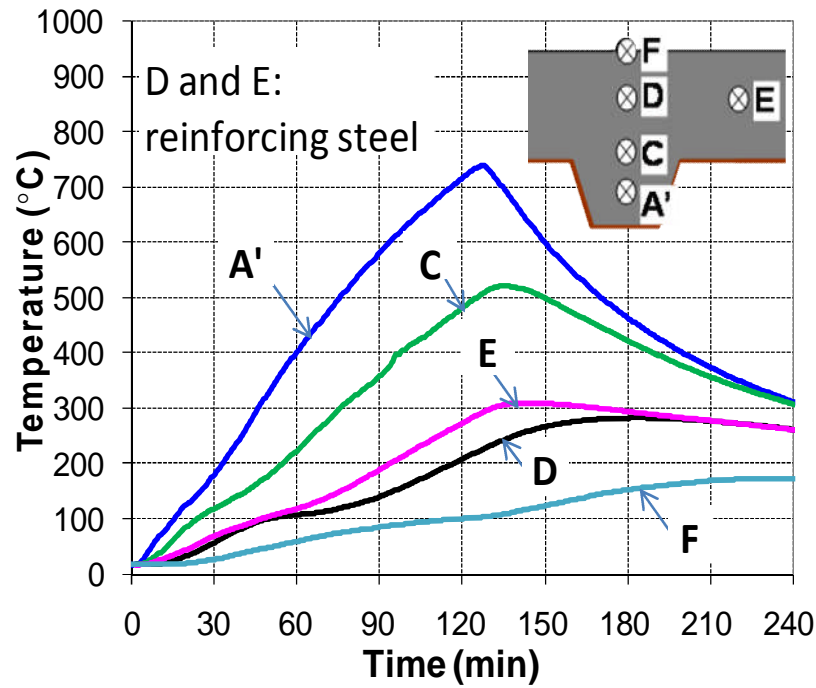

FRACOF

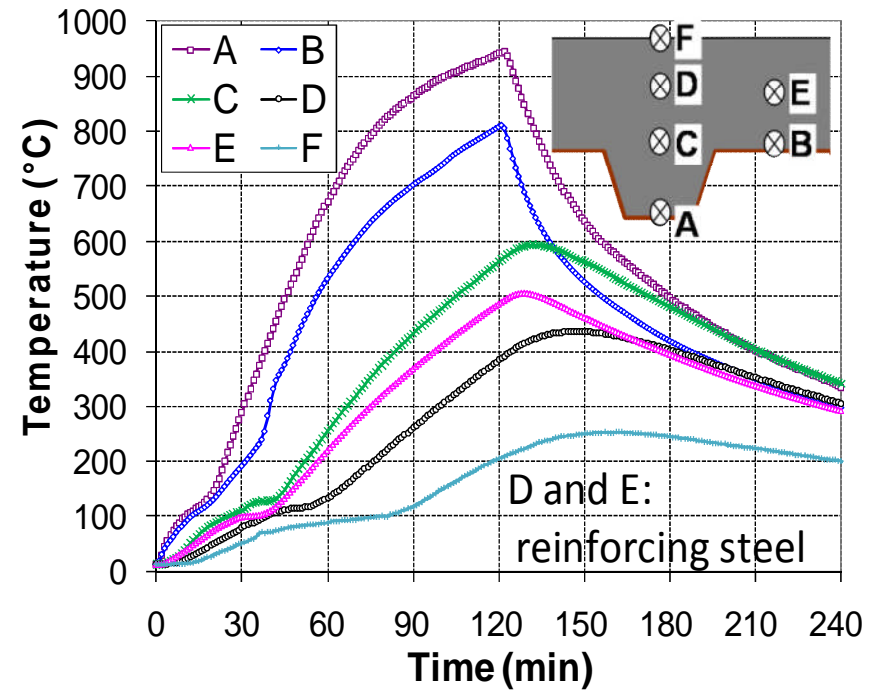

COSSFIRE

Evolutia deplasarii verticale

FRACOF

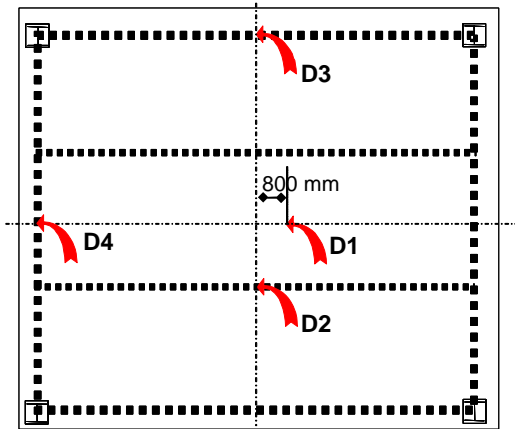

COSFIRE

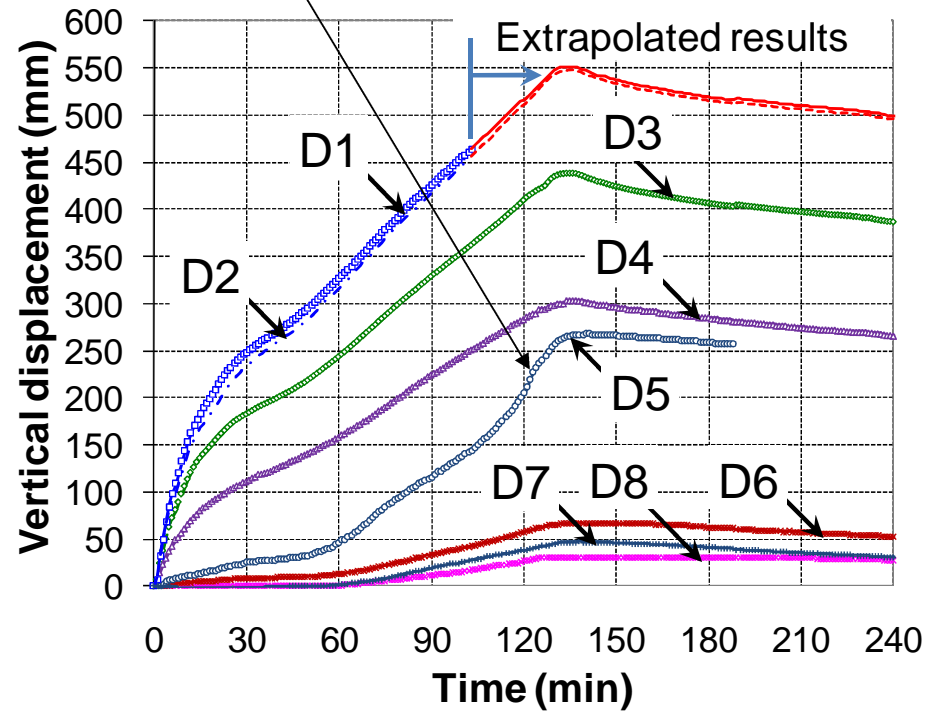
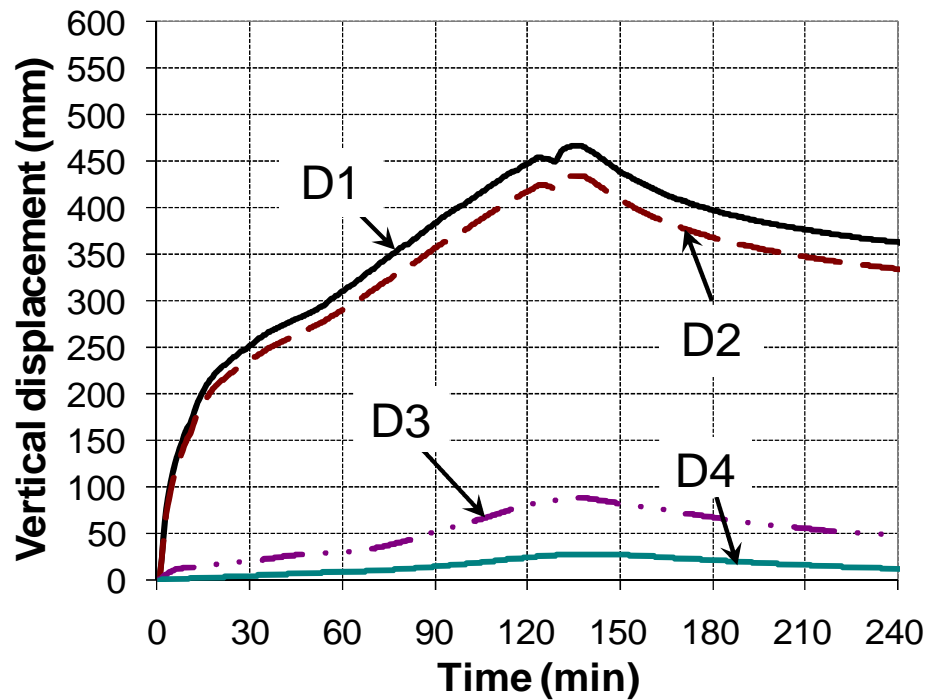
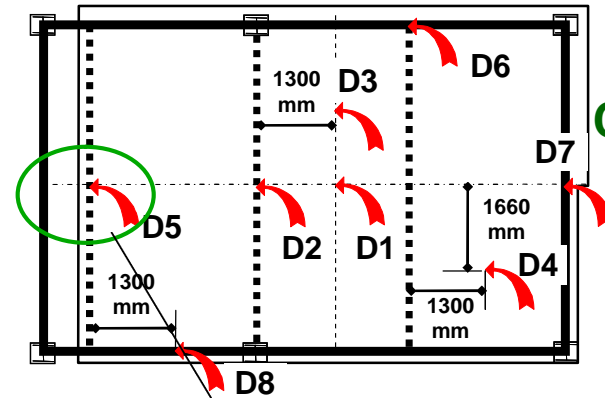

COSSFIRE – strivirea betonului

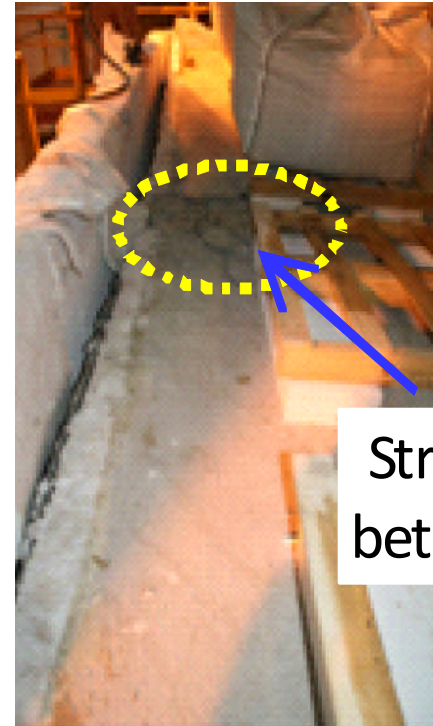

Strivirea
betonului

Fara cedare dupa 120 minute, chiar daca la o grinda de capat, din cauza protectiei la foc deteriorate au aparut deplasari excesive, care au cauzat strivirea betonului la partea superioara

FRACOF - Cedarea imbinarii sudate intre plasele de armatura

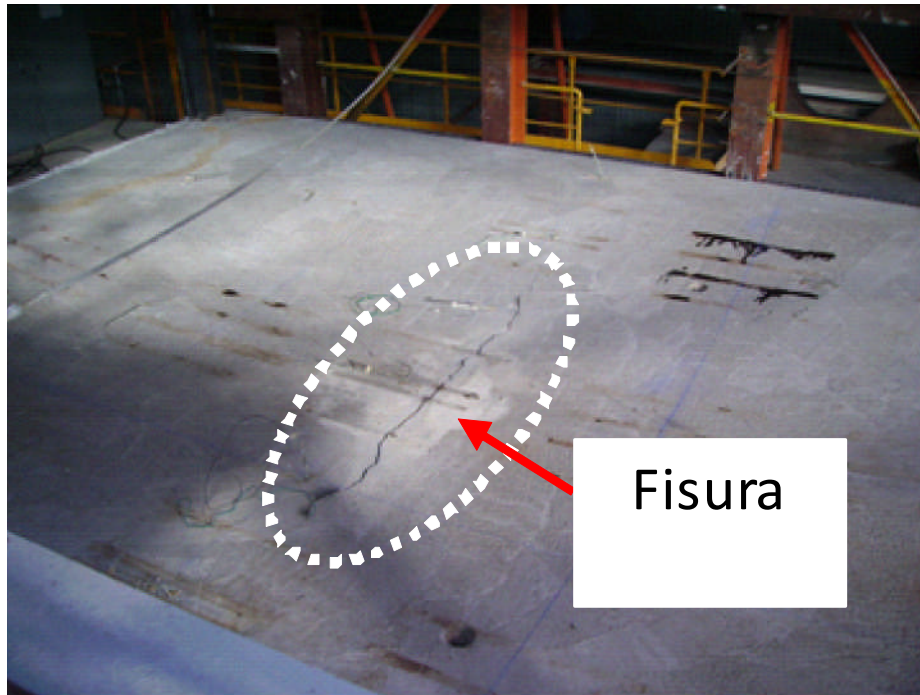

Fara cedare dupa 120 minute, chiar daca la 105 minute a aparut o fisura centrala, cauzata de cedarea imbinarii intre plasele de armatura, realizata necorespunzator

Comparatie cu metoda de proiectare

	FRACOF		COSSFIRE	
	Test	Metoda de proiectare	Test	Metoda de proiectare
Rezistenta la foc - R (min)	> 123	120	> 123	90
Sageata (mm)	450	$(L+I)/30=513$	527	$(L+I)/30=522$

- **Observatie!**
 - Testele au fost oprite dupa 123 minute de foc ISO, fara a se produce cedarea planseelor

Concluzii in urma testelor sub foc ISO – FRACOF si COSSFIRE

- **Comportare la foc corespunzatoare a planseelor compuse protejate partial, sub foc ISO de lunga durata (> 120 minute) datorita efectului de membrana**
- **Robustete mare a sistemului structural, in prezenta unor cedari locale**
- **Metoda de proiectare ofera rezultate securitare in comparatie cu rezultatele experimentale**

Utilizarea unui model avansat de calcul – FRACOF

