



PART 2
THERMAL RESPONSE

Resistance to fire - Chain of events



1: Ignition



2: Thermal action

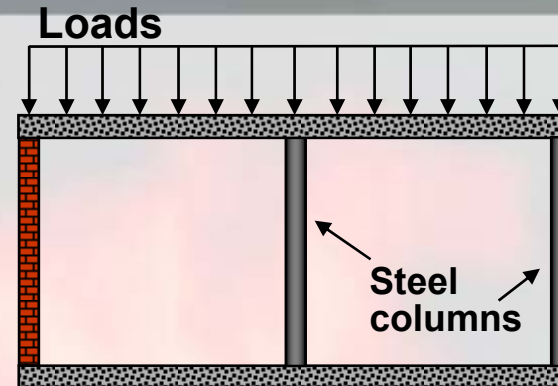

3: Mechanical actions

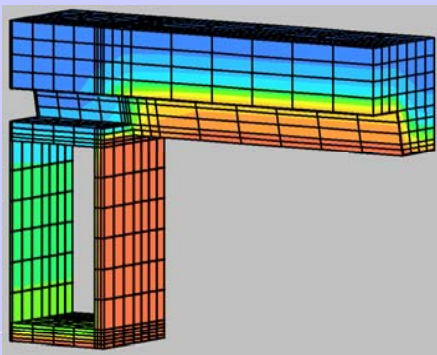

4: Thermal response

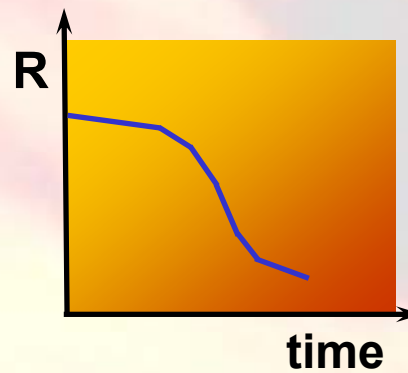

5: Mechanical response

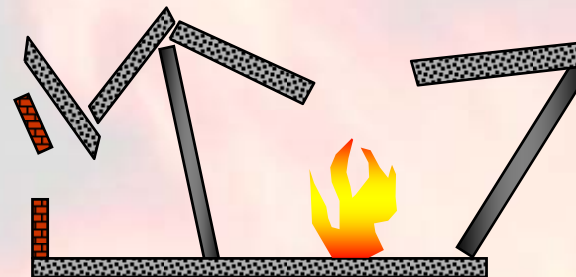

6: Possible collapse

Contents

- 1. Introduction
- 2. Basics & illustrations
- 3. Calculation rules for steel elements
- 4. Calculation rules for composite elements

- Annexes
 - ✧ Fourier's differential equation
 - ✧ Thermal response of steel elements
 - ✧ Tabulated data & simple models according to ČSN EN 1994-1-2
 - ✧ EC rules for FR w.r.t. insulation of composite slabs
 - ✧ EC rules for temperature sagging reinforcement in composite slabs

Thermal response

Basics

- Thermal conduction ($= \lambda$)
- Thermal capacity ($= \rho \cdot c_p$)

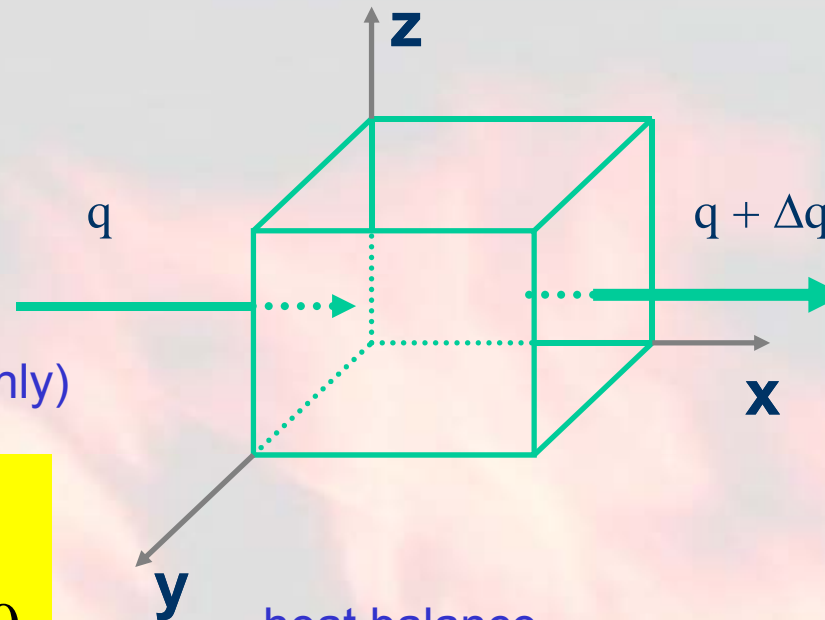

DV: (shown for 1 direction only)

$$\frac{\partial(\rho c_p \Theta)}{\partial t} + \frac{\partial(\lambda \frac{\partial \Theta}{\partial x})}{\partial x} = 0$$

heat balance

$$\Delta q / \Delta x + \Delta(\rho c_p \Theta) / \Delta t = 0$$

boundary condition: incoming/outgoing flux at surface: $h_{\text{net,tot}}$
 initial condition: room temperature conditions

Fourier's law

$$q = \lambda \Delta \Theta / \Delta x$$

Thermal conductivity

Concrete vs. steel

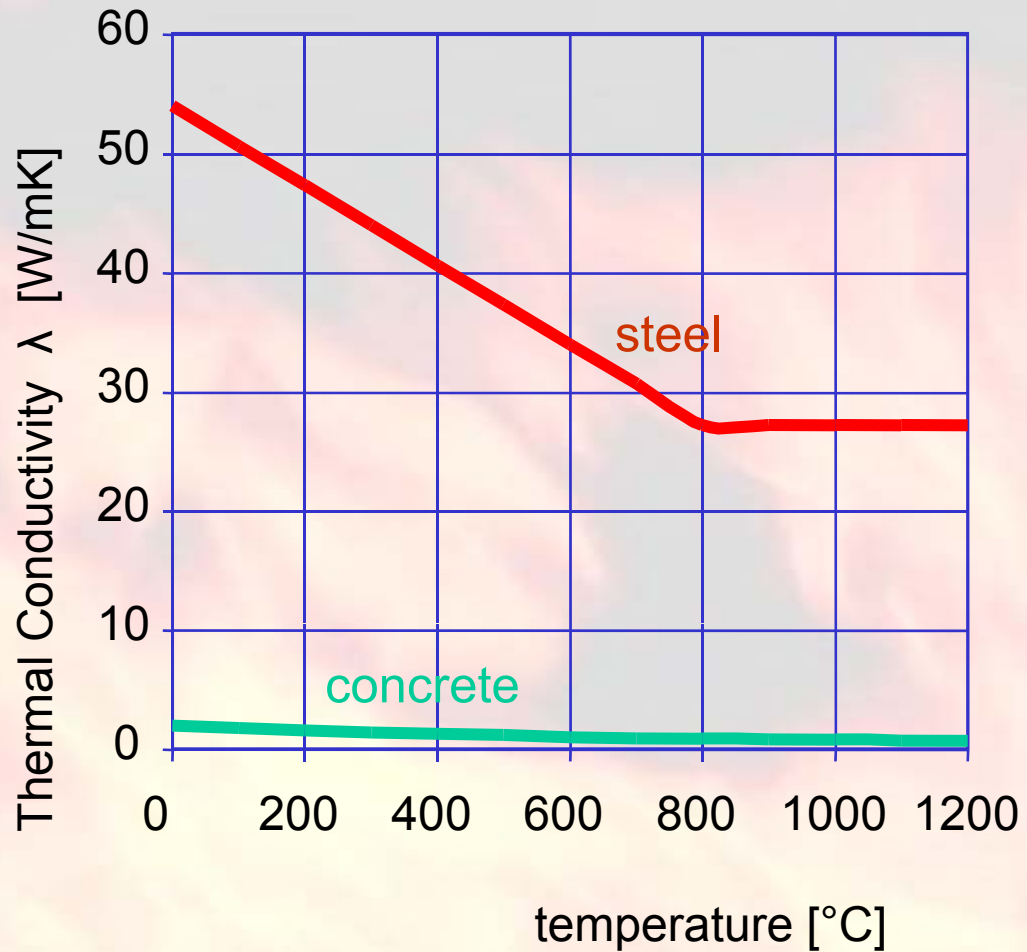

Thermal capacity Concrete vs. steel

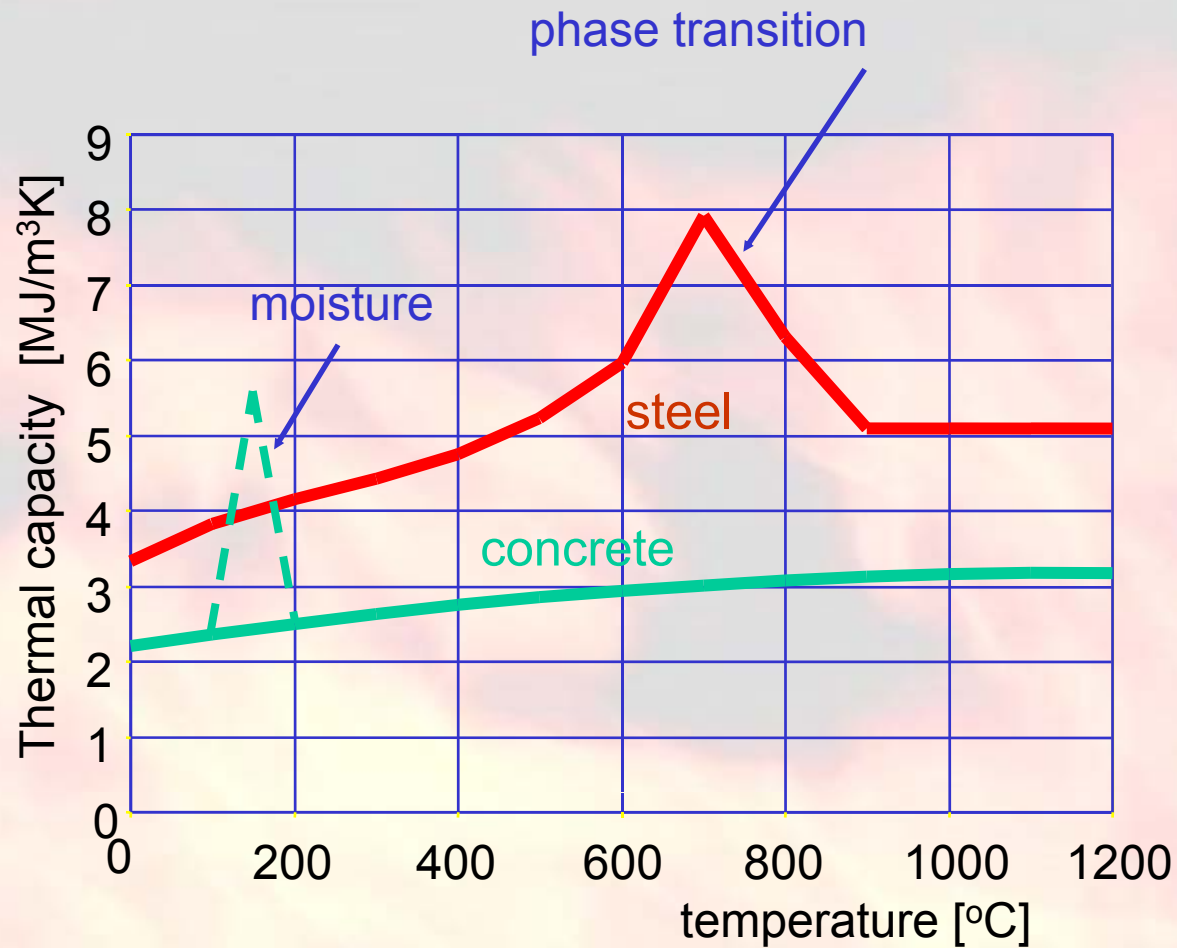

Thermal response

Steel beam/concrete slab (2D)

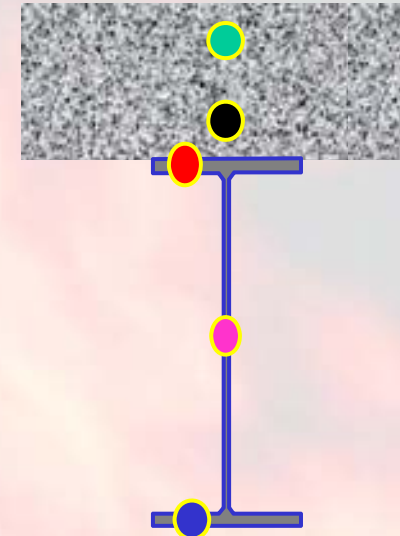
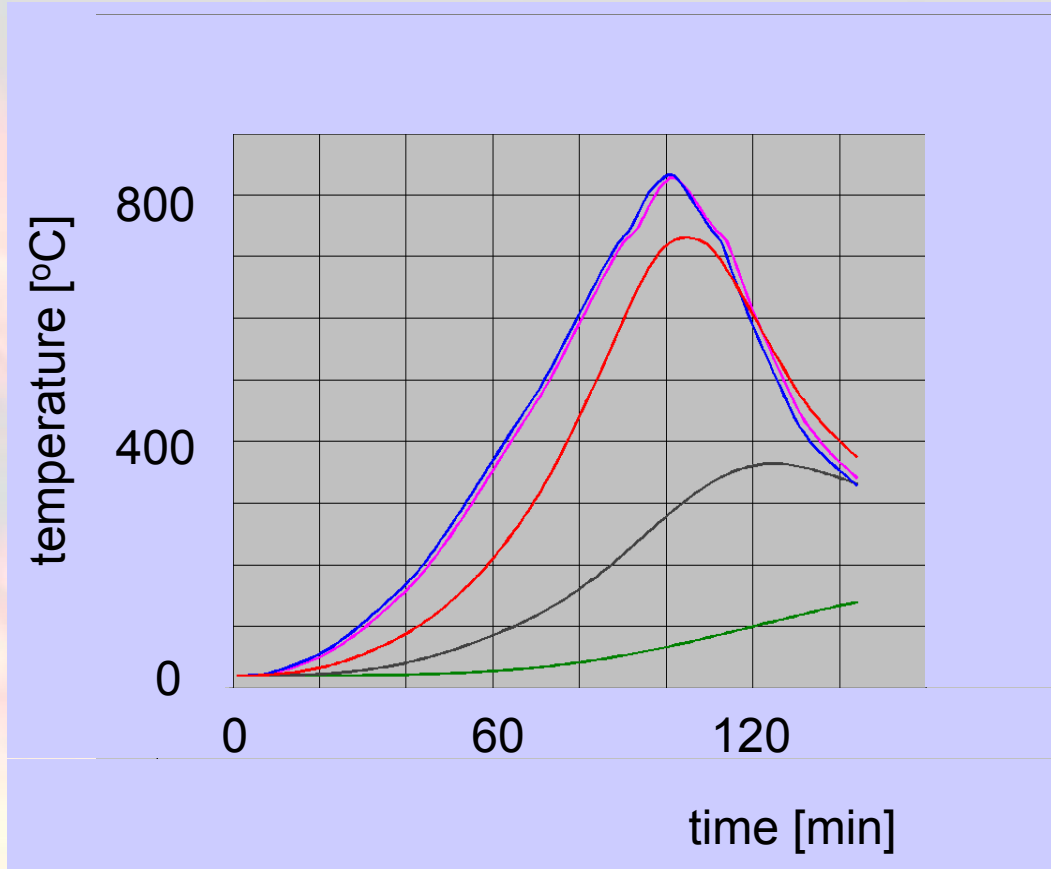

Thermal response Composite slab (2D)

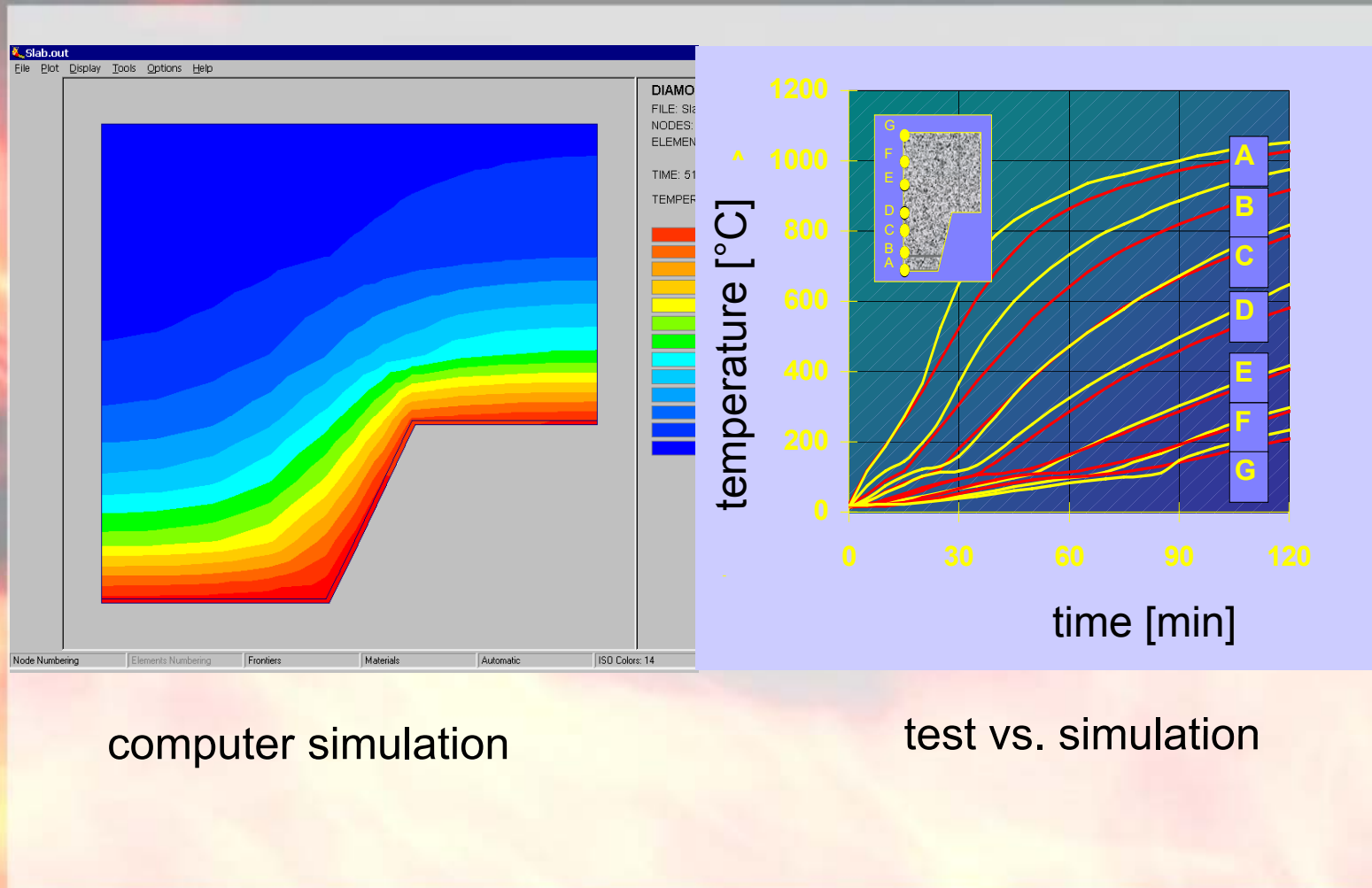

computer simulation

test vs. simulation

Thermal response Composite edge beam (3D)

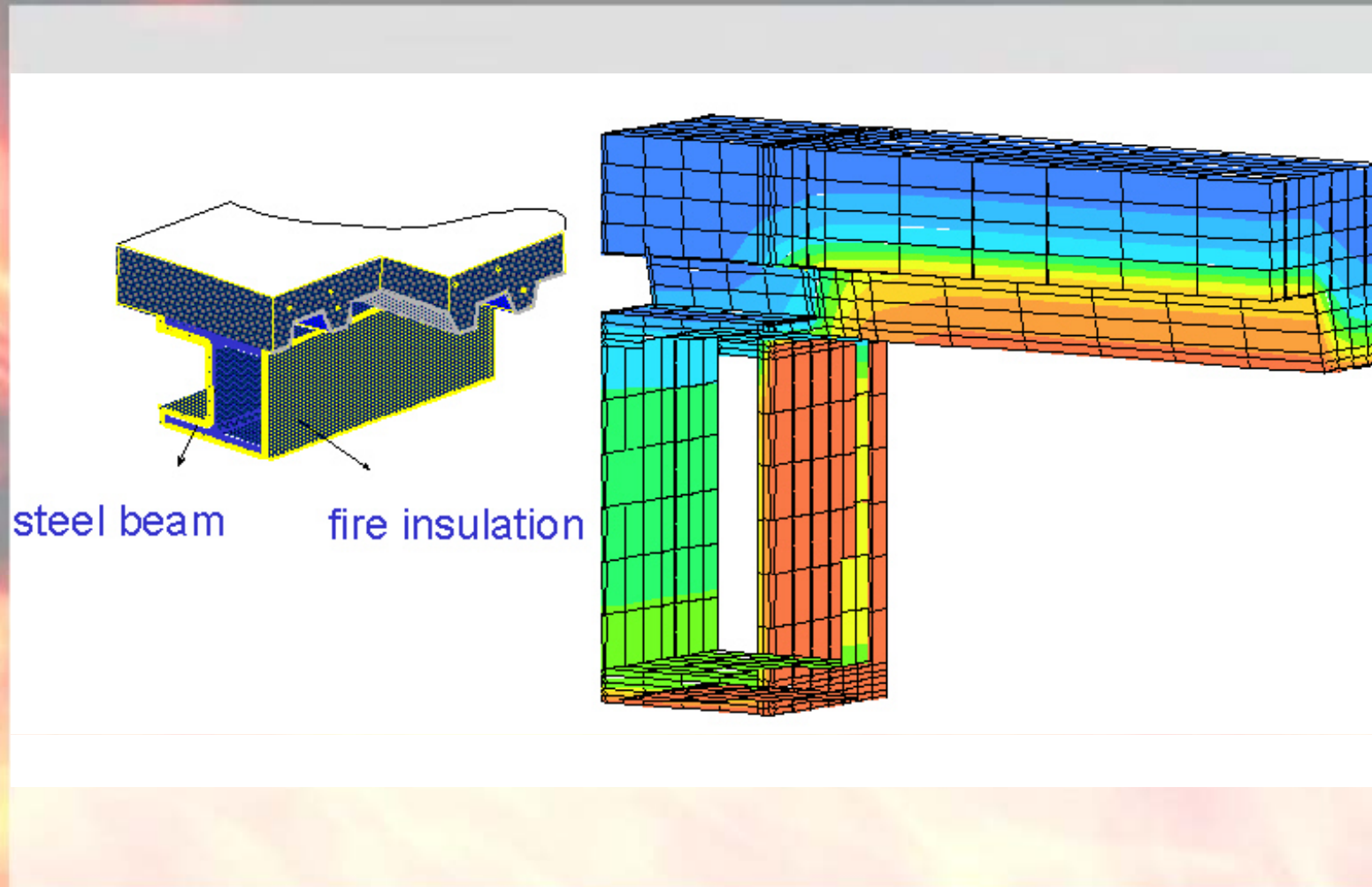

Calculation rules for steel elements

- Scope
- Bare steelwork
- Insulated steelwork
- Design parameters for the temperature development
 - ✧ General
 - ✧ Section Factor
 - ✧ Characteristics fire protection
 - ✧ Non-standard fire conditions

Resistance-to-Fire of Steel Elements

Principles

- Load bearing function only
 - ⇒ Load bearing capacity
- Uniform temperature distribution
 - ⇒ Critical steel temperature concept

Note: refer to ČSN EN 1993-1-2 (simple calculation models)

Resistance-to-Fire “Steel elements” Calculation procedure

- Step 1: determine mechanical response $\mu_a \Rightarrow \Theta_{crit}$
- Step 2: determine thermal response $\Rightarrow \Theta_a$
- Step 3: determine fire resistance \Rightarrow fire res.

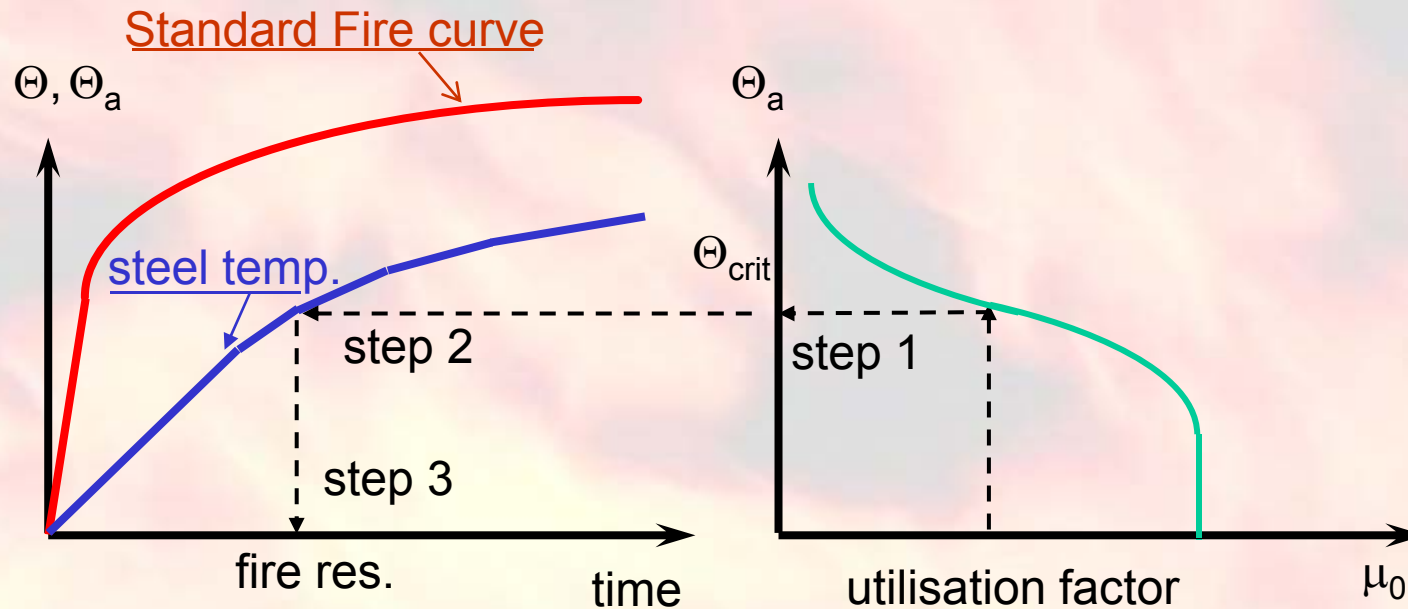

Thermal actions

Heat transfer exposed side

- Radiative heat transfer:

$$\dot{h}_{net,r} = \Phi \cdot \varepsilon_m \cdot \sigma \cdot [(\Theta_r + 273)^4 - (\Theta_m + 273)^4]$$

- Convective heat transfer:

$$\dot{h}_{net,c} = \alpha_m \cdot (\Theta_g - \Theta_m)$$

with:

Θ_{rad} is radiation temperature [°C] $\Rightarrow \Theta_{rad} \rightarrow \Theta_g \rightarrow$ fire curve

Θ_m is surface temperature [°C] \Rightarrow thermal response

ε_m is surface emissivity [-] \Rightarrow steel: 0.7

α_c is coefficient convection \Rightarrow 25 - 50 W/m²K
(depending on fire model)

Φ is configuration factor [-] $\leq 1.0 \Rightarrow$ safe: 1.0

ρ is Stephan Boltzmann constant $= 5.67 \cdot 10^{-8}$ W/m²K⁴

Note: simplified!; for details: see ČSN EN 1991-1-2

Thermal response Steel profiles

$$\frac{\partial(\rho c \Theta)}{\partial t} + \frac{\partial(\lambda \frac{\partial \Theta}{\partial x})}{\partial x} = 0$$

boundary & initial
conditions

$$\frac{d \cup_d}{dt} = \frac{\dot{h}_{tot} A_m}{\rho_a c_a V}$$

with

A_m is exposed surface area member [m²/m]

V is volume member [m³/m]

Note: key is uniform temperature distribution

Temperature rise bare steelwork

Basic equation

$$\frac{d\Theta_a}{dt} = k_{sh} \frac{A_m/V}{\rho_a c_a} \cdot \dot{h}_{net,tot} \quad \dots (1)$$

Legend:

$\Delta\Theta_a$: increase steel temp.

Δt : time step

A_m/V section factor

K_{bare} : heat transfer coef.

k_{sh} : corr. coef. shadow effect



$$\Delta\Theta_a = k_{sh} \frac{K_{bare}}{\rho_a c_a} \cdot \frac{A_m}{V} \cdot (\Theta_g - \Theta_a) \cdot \Delta t \quad \dots (2)$$

with

$$K_{bare} = \alpha_c + \frac{\varepsilon_m \sigma \left[(\Theta_g + 273)^4 - (\Theta_a + 273)^4 \right]}{\Theta_g - \Theta_a} \quad \dots (3)$$

Shadow effect

Basics

- Shadow effect caused by local shielding of radiative heat transfer, due to shape of steel profile, i.e.:
 - ✧  profiles, shadow effect: yes
 - ✧  profiles, shadow effect: no

- Without thermal radiation, no shadow effect; hence:
 - ✧ bare members, shadow effect: yes
 - ✧ insulated members, shadow effect: no

Shadow effect Consequences

➤ Unprotected members:

$$\Delta \Theta_a = k_{sh} \frac{A_m/V}{c_a \rho_a} \dot{h}_{net} \Delta t$$

with:

✧ for I – sections:

$$k_{sh} = 0.9 [A_m/V]_{box} / [A_m/V]$$

✧ for “all” other sections:

$$k_{sh} = [A_m/V]_{box} / [A_m/V]$$

➤ Protected members: no effect

Temperature rise insulated steelwork

Basic equations

$$\Delta \Theta_a = \frac{K_{ins}}{\rho_a c_a} \cdot \frac{A_m}{V} \cdot (\Theta_g - \Theta_a) \cdot \Delta t \quad \dots (a)$$

with

$$K_{ins} = K_{ins} \left(\frac{\lambda}{d}, \rho_p, c_p, \rho_a, c_a \right) \quad \dots (b)$$

Notes: (a) $\Theta_g - \Theta_m \ll \Theta_m - \Theta_a$
 (b) for light weight insulation:
 $K_{ins} \approx \lambda/d$

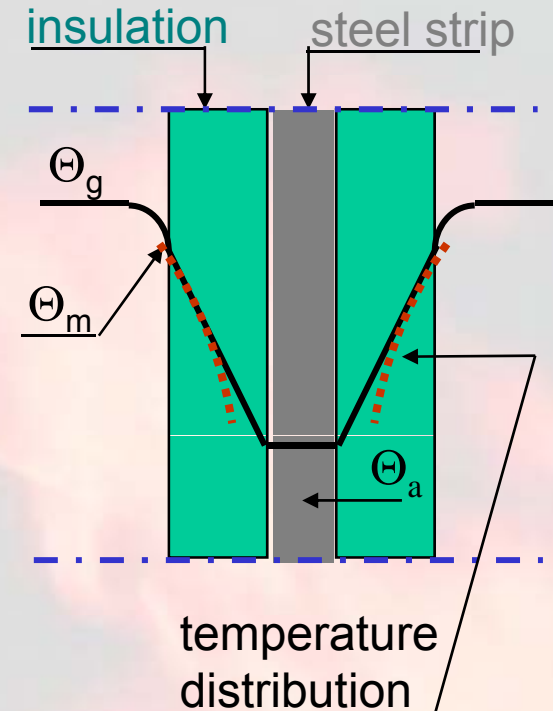

Temperature development in steel profiles

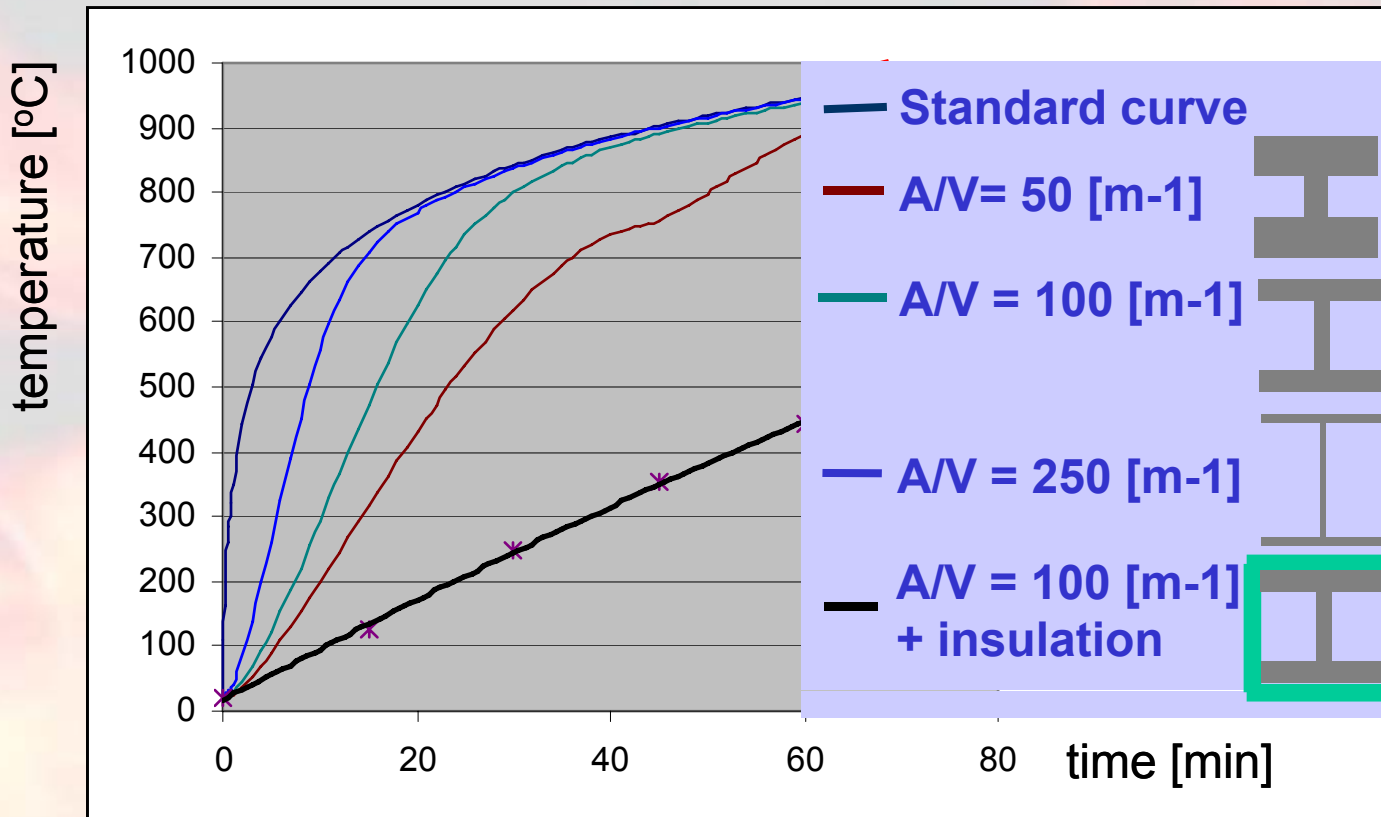

Steel temperature as function of Section Sector

Bare steel profiles

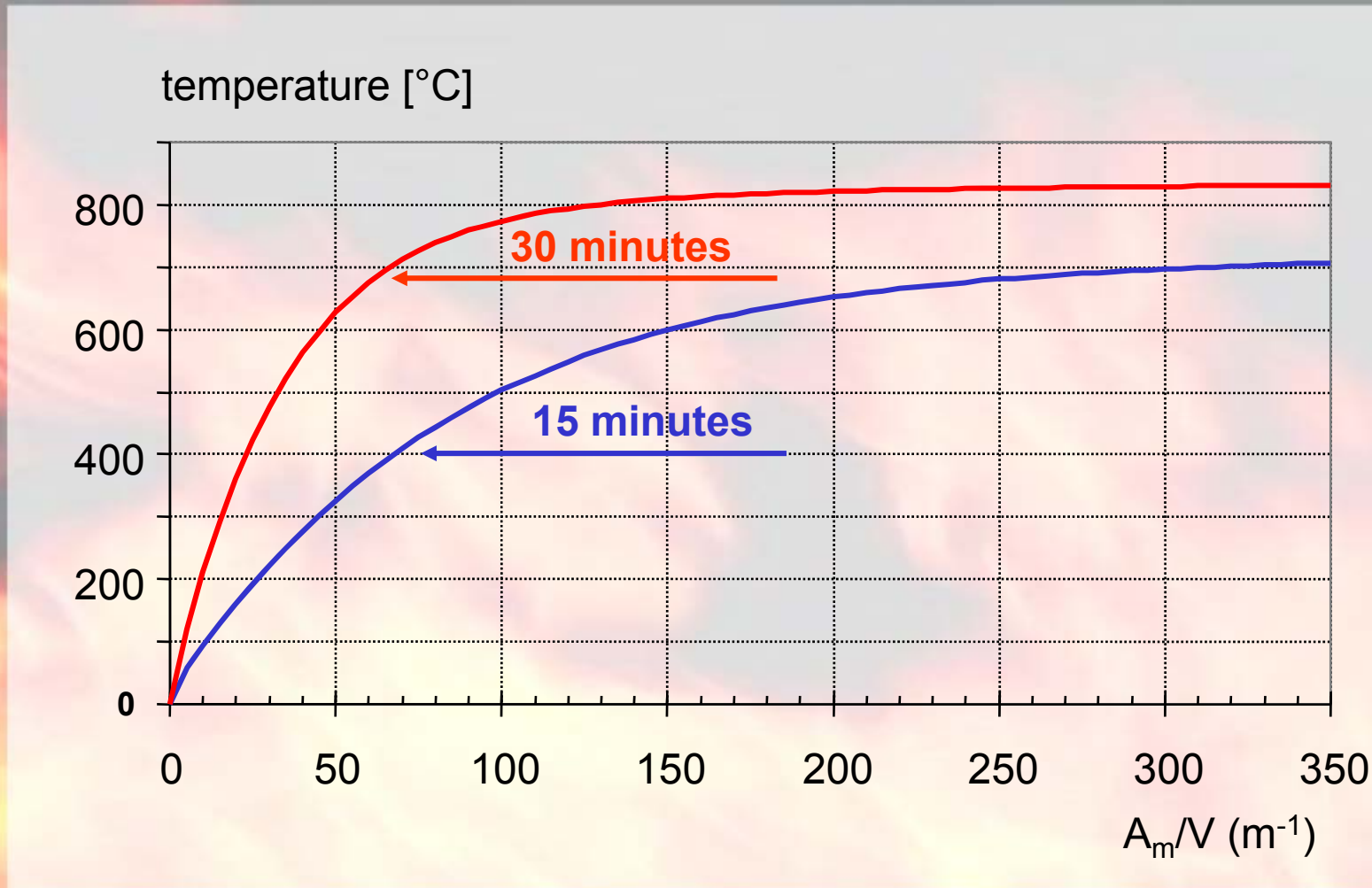

Steel temperature as function of Section Factor Insulated steel profiles

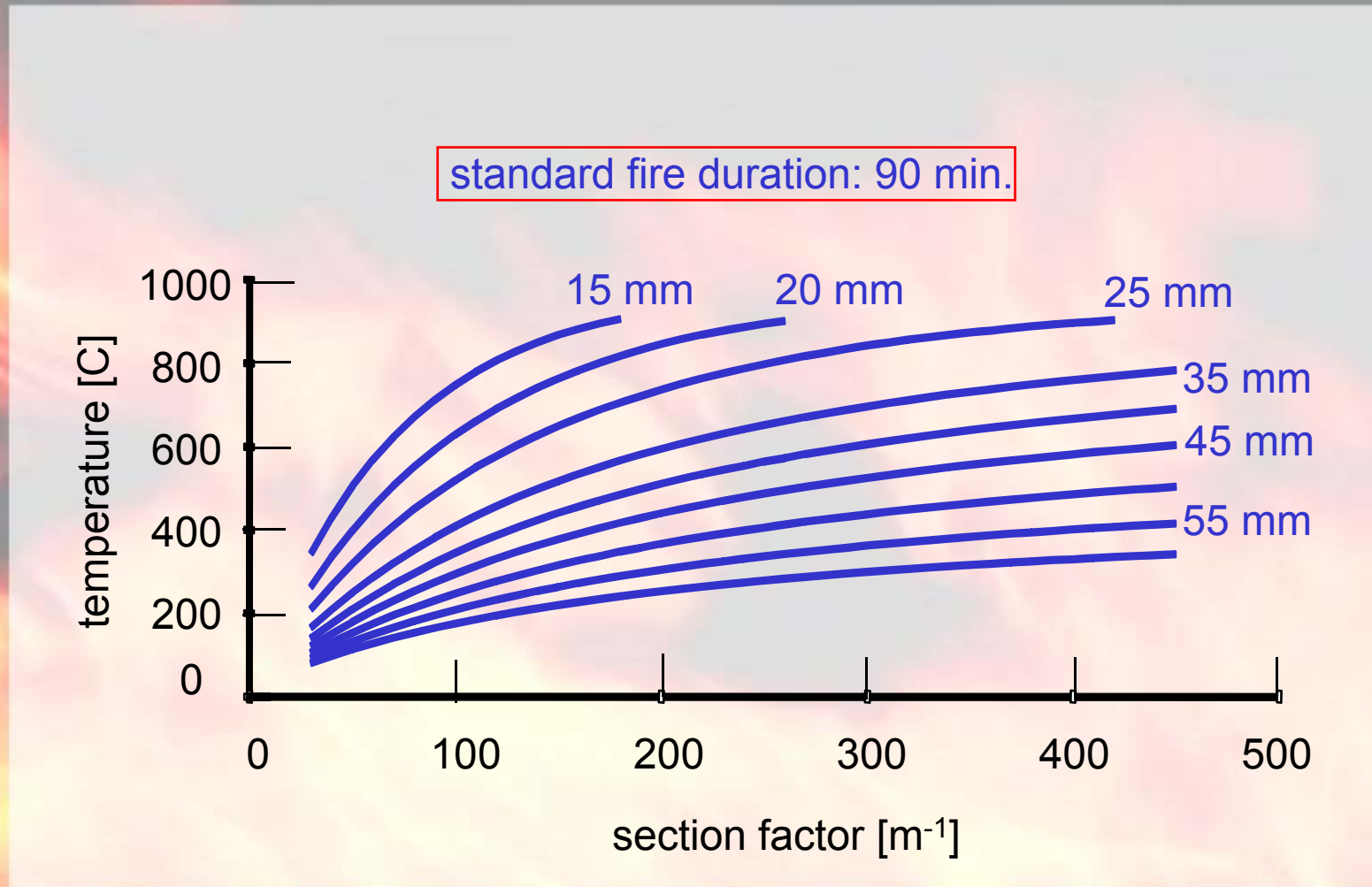

Section Factor steel profile Concept

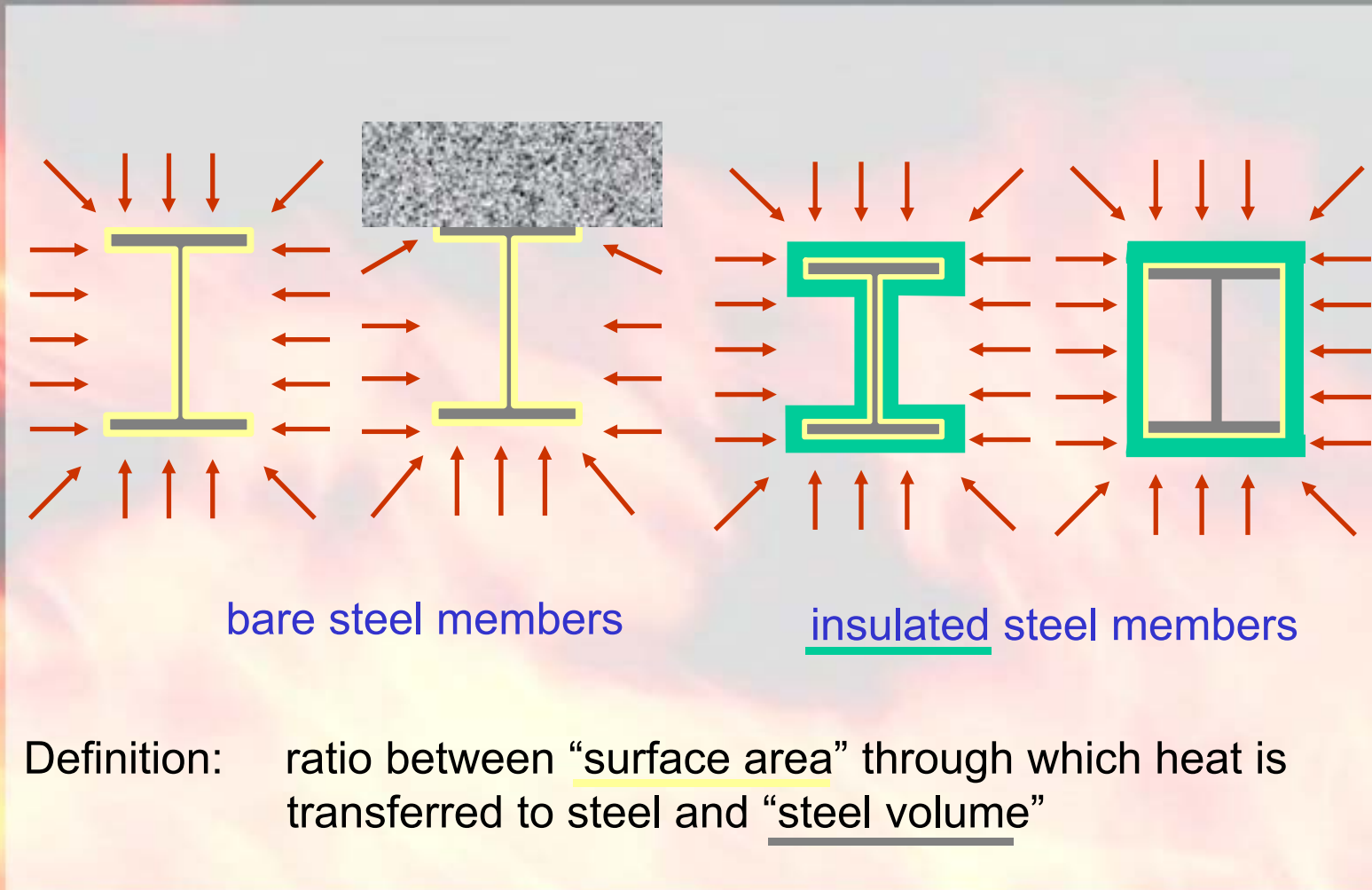

Section Factor (A/V) Numerical values

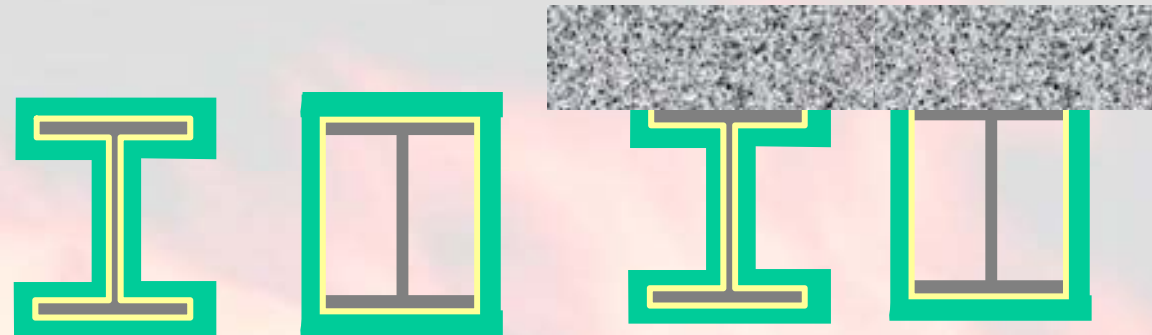

IPE100	387	300	334	247
HE280A	165	113	136	84
HE320B	110	77	91	58

Note: range: $\approx 50 - 400 \text{ [m}^{-1}\text{]}$

Heat transfer coefficient Insulated steel members

- Approximation: $K_{\text{ins}} \approx \lambda/d$ (for light weight insulation)
with: d is thickness insulation material
 λ is coefficient of thermal insulation
- Determination: semi-empirical approach
⇒ ENV 13381, p. 4

Note: Do not use “room temperature handbook values” for λ in fire design calculations!

Characterisation tests

Fire insulation steel elements

- Aim: insulation characteristics fire protection steelwork
- Complication: “Stickability”
- Methodology:
 - ✧ loaded & unloaded beam (2 pairs)
 - ✧ unloaded columns (10 x)
- Ref.: EN 13381-4



beam before fire test

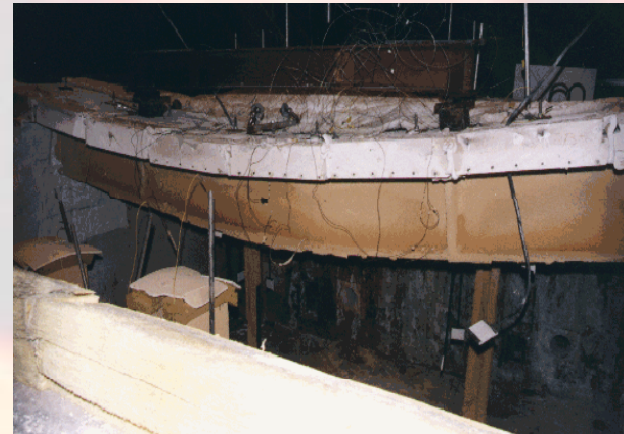

beam after fire test

Fire insulation systems

Options

- Boards
- Sprays
- Intumescent

- Screens
 - ✧ to protect horizontal elements (→ floor construction)
(EN 13381-1)
 - ✧ to protect vertical elements (→ partitions)
(EN 13381-2)

Note: for details on insulation characteristics refer to:
(a) test reports fire labs
(b) information manufacturers

Euronomograms

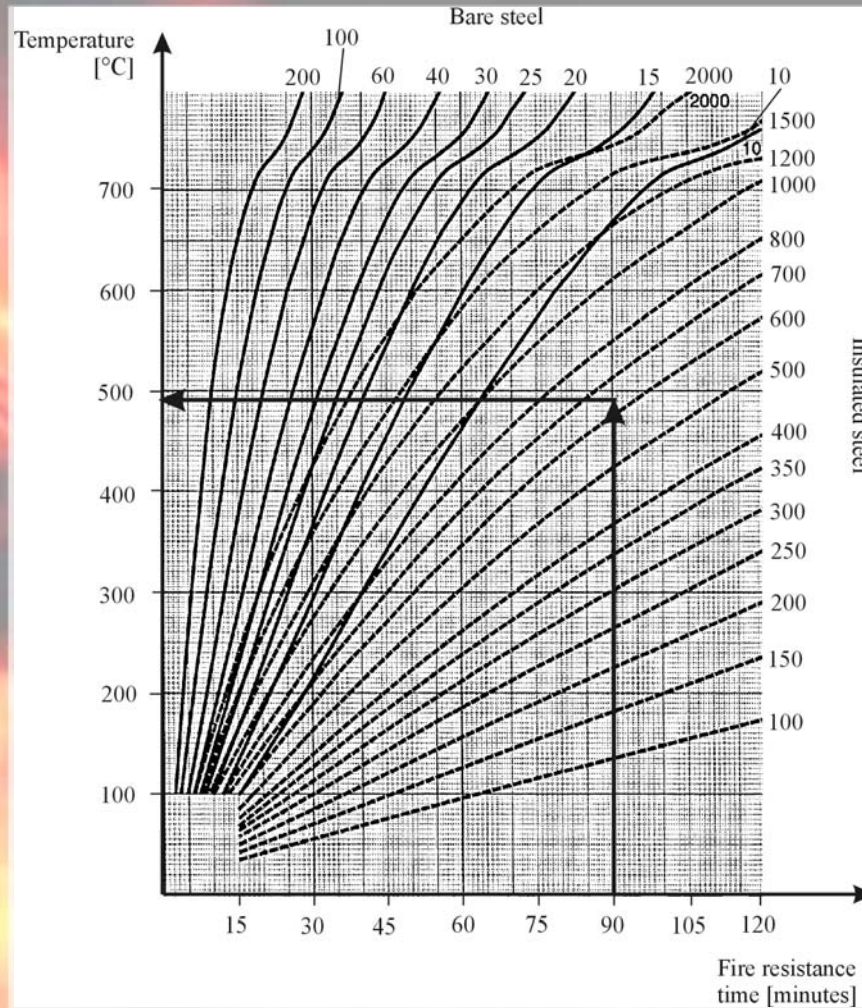

for insulated steelwork;
to be used as first
approximation

Calculation rules for composite elements

- Scope
- Thermal response steel columns with concrete between flanges
- Verification of the insulation criterion for composite slabs
- Temperature in additional reinforcement in composite slabs
- Thermal response of concrete filled SHS columns
- Evaluation

Composite slabs & beams

Options

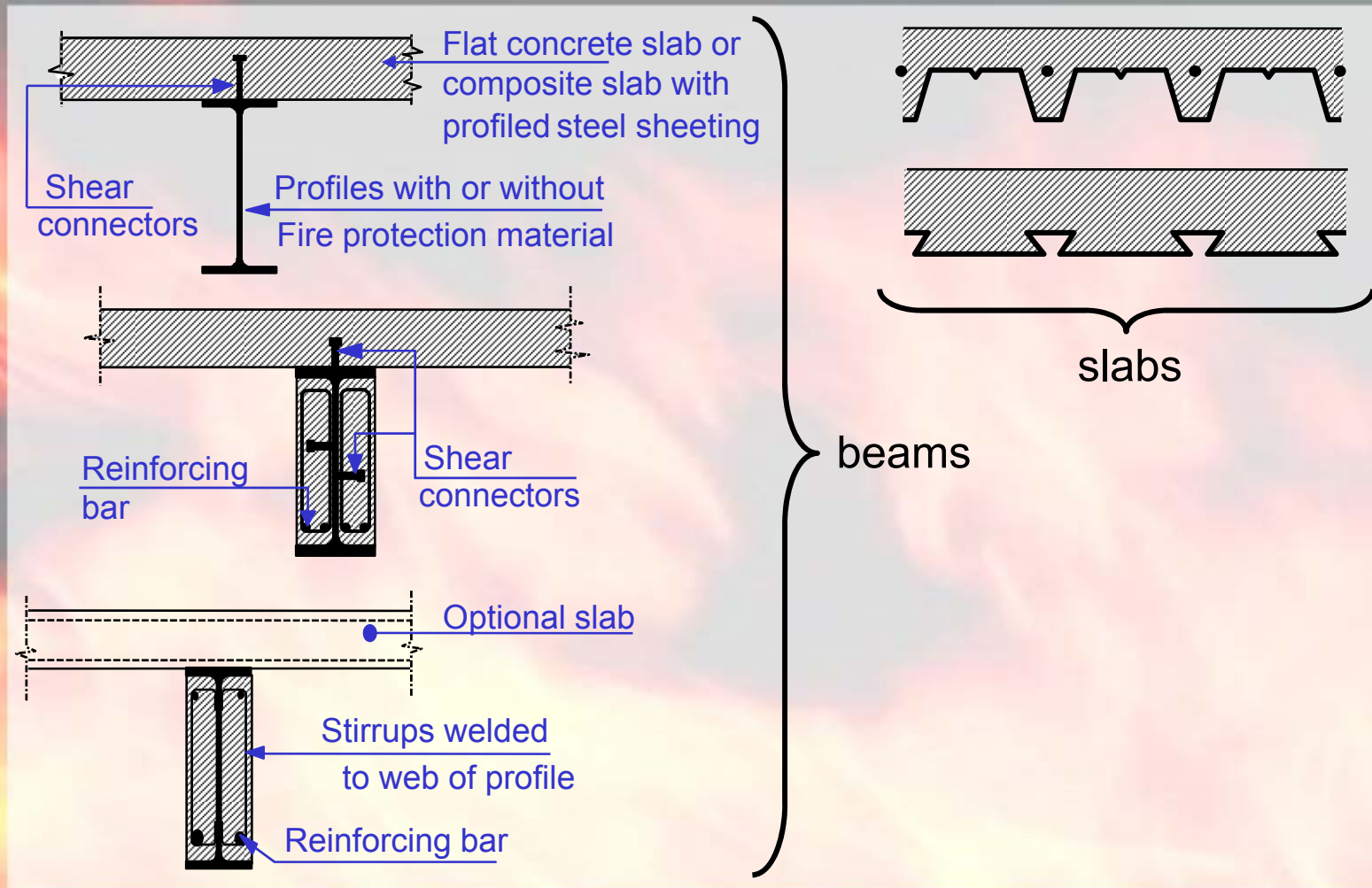

Composite columns

Options

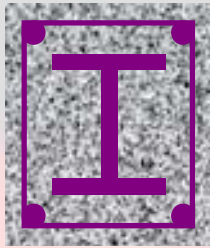

(a)



(b)

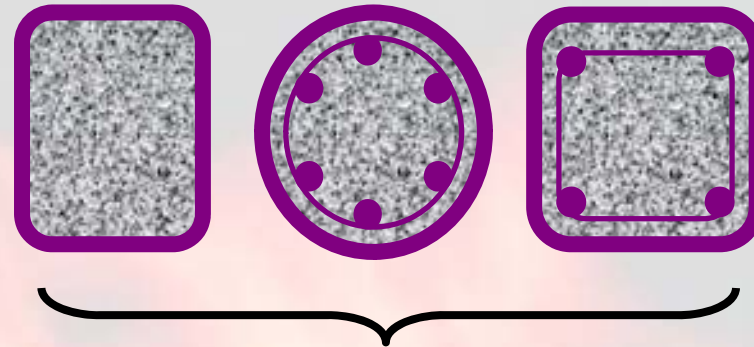

(c)

- a: steel embedded in concrete (traditional approach)
- b: concrete between flanges (f.r. dependent on reinforcement)
- c: concrete filled SHS
 - without reinforcement (f.r. ca. 30 minutes or less)
 - with reinforcement (f.r. dependent on reinforcement)

Calculation procedure thermal response Composite elements

- Non-uniform temperature distribution
- Load bearing and (possibly) separating function
 - ✧ Load bearing capacity
 - ✧ Thermal insulation
 - ✧ Integrity
- Options
 - ✧ tabulated data
 - ✧ simple calculation model
 - ✧ advanced calculation model

Note: Reference: ČSN EN 1994-1-2

Composite elements

Calculation rules thermal response

- Similar to concrete elements
- Complications due to shape
- Simple calculation rules available
 - ✧ variety of backgrounds
 - ✧ see ČSN EN 1994-1-2

Thermal response composite elements Advanced model (illustration)

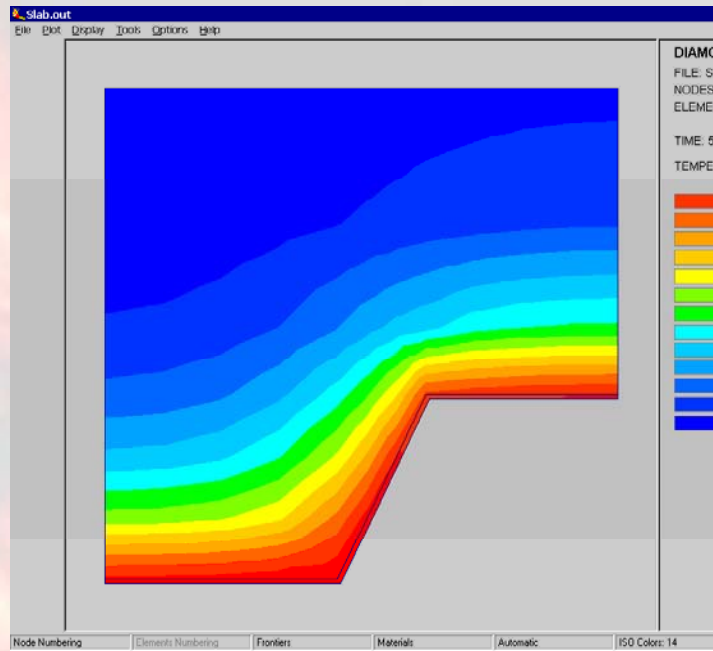

computer simulation

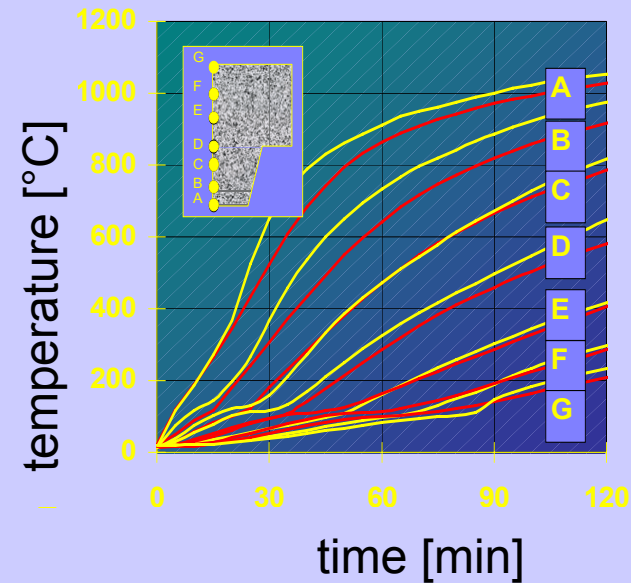

test vs. simulation

Composite elements

Simple calculation models thermal response

- Semi-empirical approach
- Parameter study based on systematic calculation with advanced calculation model
- Direct application of advanced calculation model

Simple calculation models

Semi-empirical approach

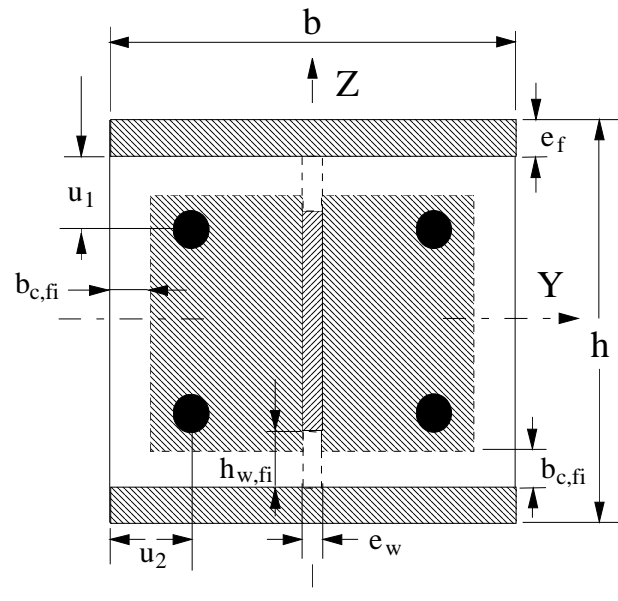

Reduced cross section

Components cross section:

- flanges steel section
- web steel section
- concrete
- re-bars

For each component:

- reduced strength
- and/or
- reduced area

For details: see ČSN EN 1994 -1-2

Simple calculation models

Parameter study approach

- Composite slabs with profiled steel sheet

Decking type	Concrete depth H_B [mm]	Concrete type
re-entrant (6x)	50, 60, 70, 80,	NCW and LWC ČSN EN 1994-1-1
trapezoidal (49x)	90, 100, 110, 120	

- standard fire conditions
- profiled shape deckings taken into account
- thermal properties according to EC
- average moisture content: 4% (NWC) and 5% (LWC)

Note: total number of simulations: 880

Typical temperature distribution at the unexposed side of a composite slab

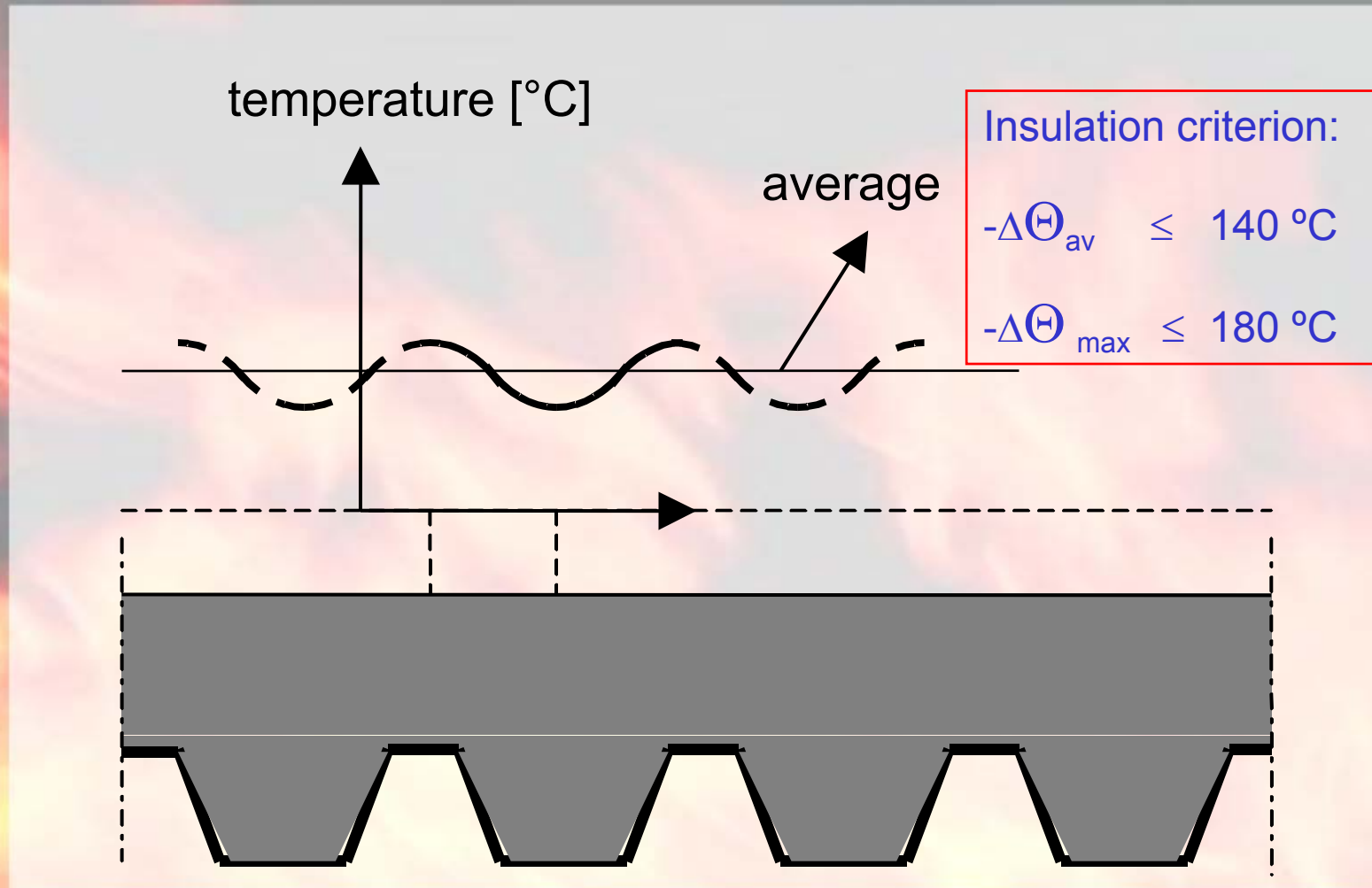

Composite slabs

Thermal insulation (illustration)

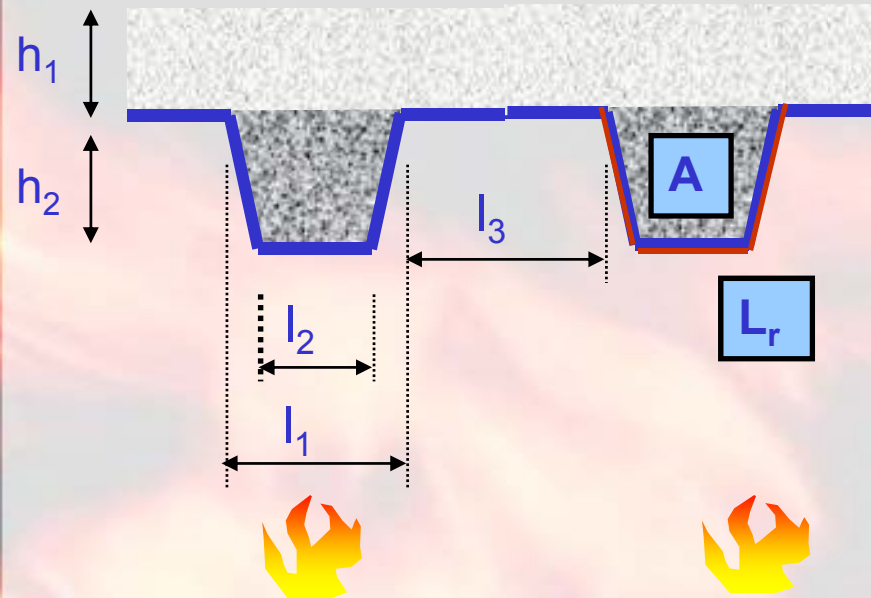

Issues:

$$t_f = t_f(l_1, l_2, \dots, A/L_r, \phi)$$

with:

l_1, l_2, \dots geometry slab
 A volume rib
 L_r exposed surface rib
 ϕ configuration factor

$$t_f = a_0 + a_1 \cdot h_1 + a_2 \cdot \phi + a_3 \cdot A/L_r + a_4 \cdot 1/L_3 + a_5 \cdot A/L_r \cdot 1/l_3 \quad [\text{min}]$$

with:

a_i coefficients, depending on duration of s.f.c. exposure

Thermal insulation composite slabs

Verification simple calculation rule

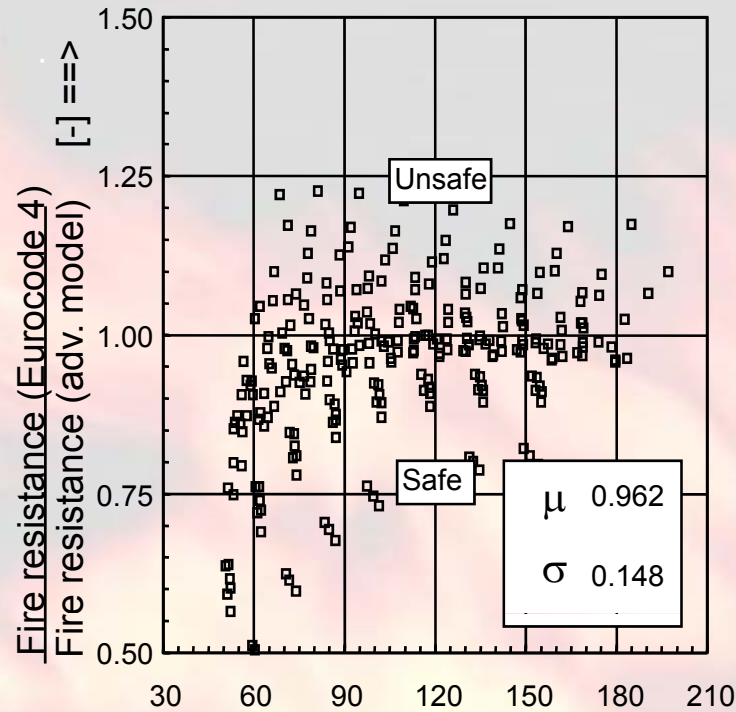

Fire resistance (adv. model) [min] ==>

(a) ČSN P ENV rule

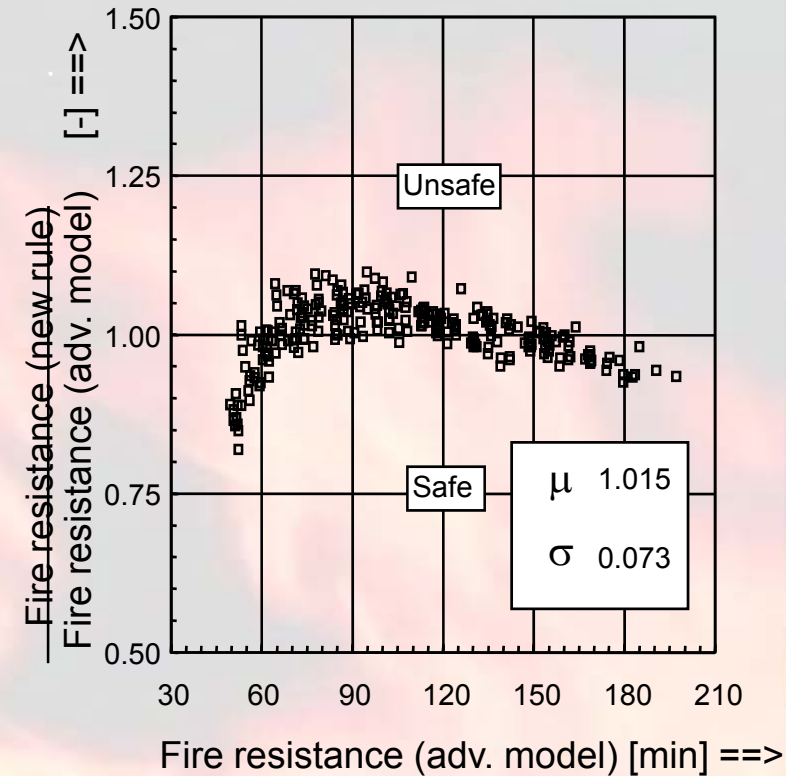

Fire resistance (adv. model) [min] ==>

(b) new rule

Composite slabs

Thermal response positive reinforcement

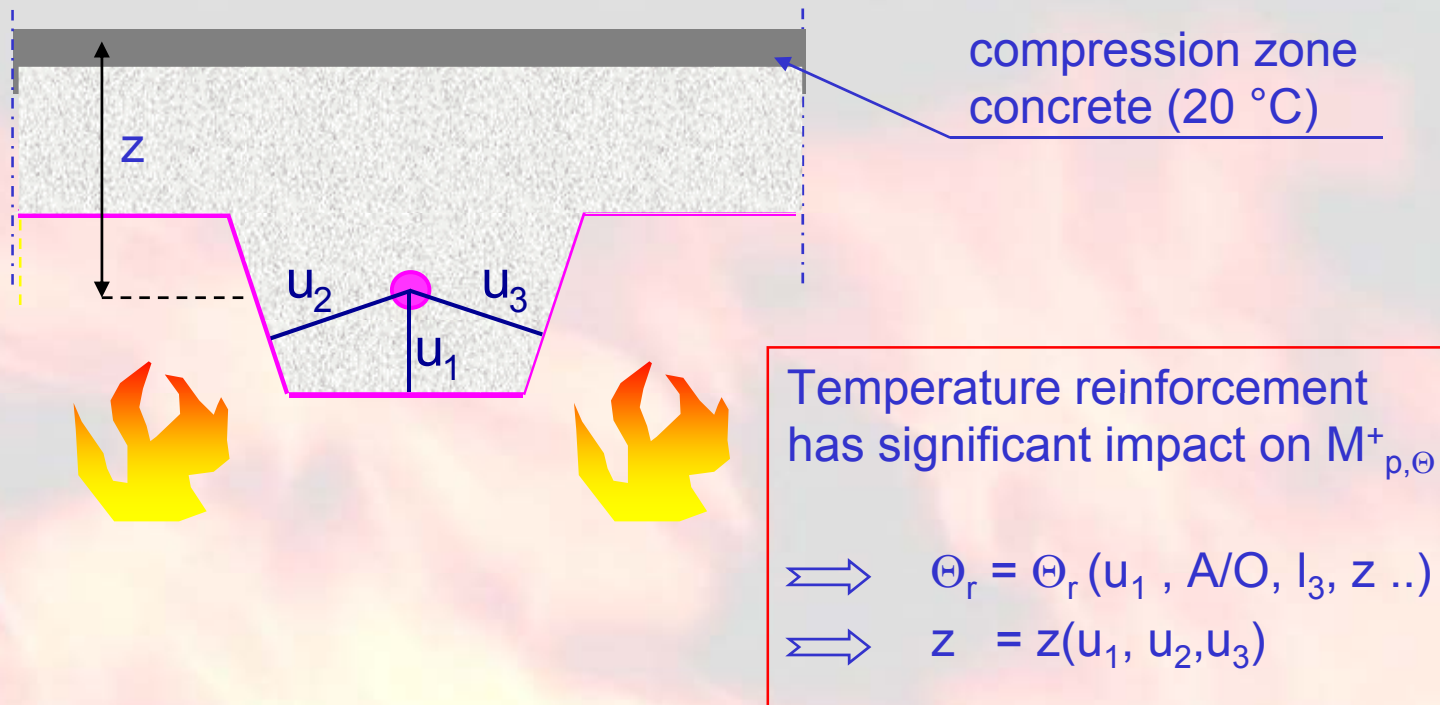

Note: steel sheet may significantly contribute to the load bearing capacity!

Thermal response positive reinforcement

Simple calculation rule

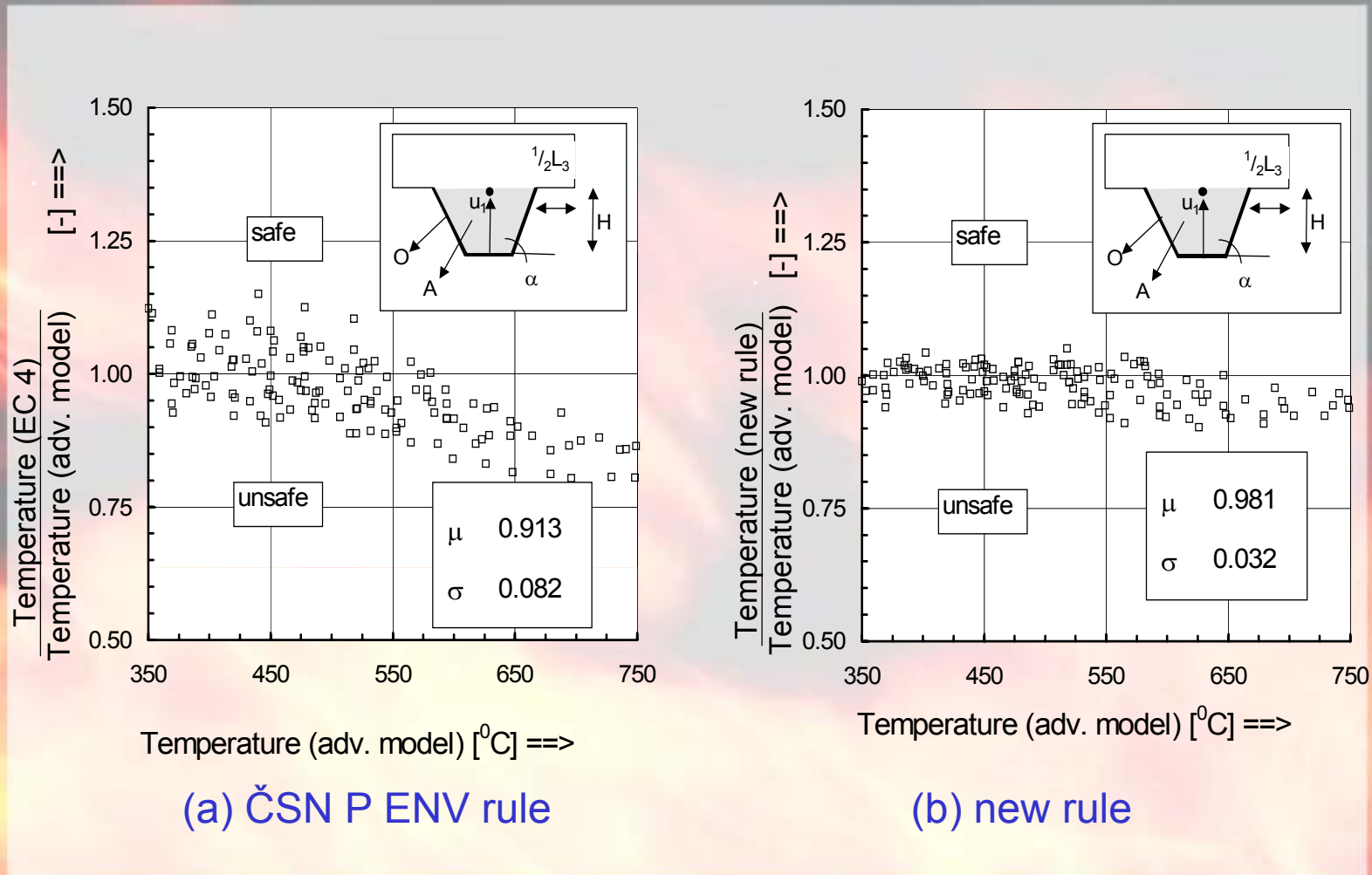

Concrete filled SHS columns

Resistance to fire (traditional approach)

- Design charts available
- Unpractical
- Need for “user friendly” design tool
- ⇒ e.g. POTFIRE

no.	concrete rebar quality	rebar %
1	C20	1.0
2	C20	2.5
3	C20	4.0
4	C30	1.0
5	C30	2.5
6	C30	4.0
7	C40	1.0
8	C40	2.5
9	C40	4.0

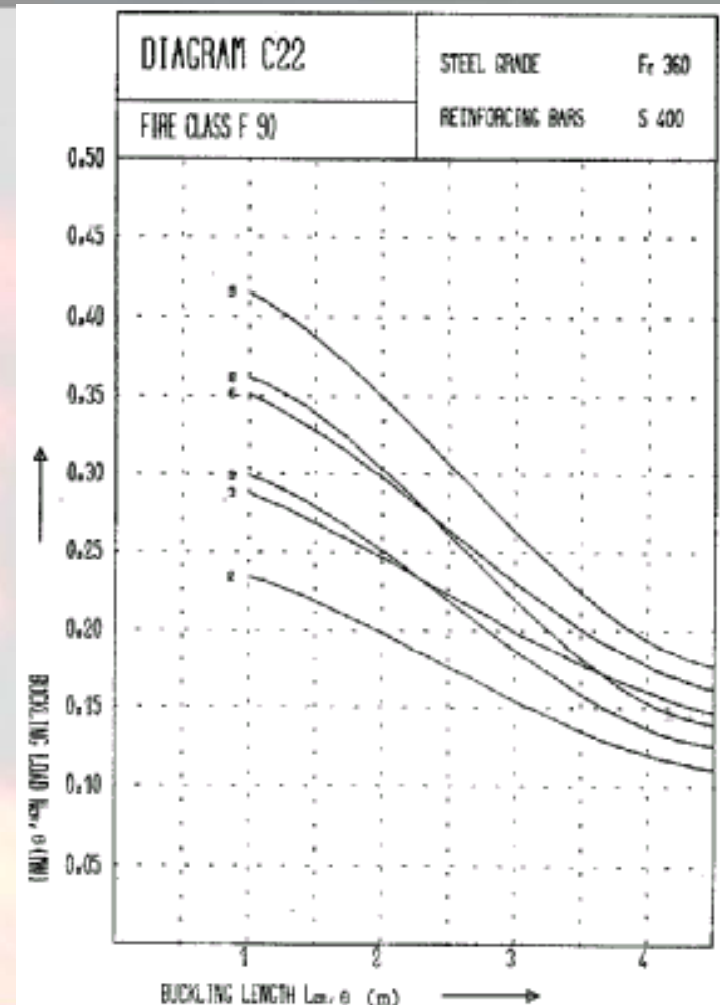
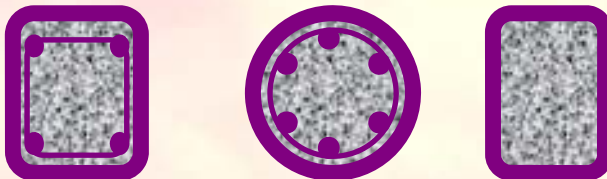

POTFIRE

In- & output

PotFire

Section

Type of section: Circular

Dimensions of steel section

Diameter: 323.9 mm

Wall thickness: 6 mm

Reinforcement bars

By nr of bars (selected) / By %

Re-bars: # 4 / 20 mm

Concrete covering from rebars axis: 30 mm

Equal to: 1.645 %

Buckling length

Buckling length: 3 m

Material characteristics

Yield strength of steel section: 355 N/mm²

Yield strength of re-bars: 500 N/mm²

Compressive strength of concrete (cylinder at 28 days): 30 N/mm²

Eccentricity of the load

Eccentricity \perp to buckling axis: 0 mm

Calculation of

Ultimate load (selected) / Fire resistance duration

Fire duration: 30 min

Result

Non-dimensional slenderness: 0.4185

Ultimate load: 2912 kN

input 

output 

pot1.txt - Notepad

Calculation nr 18

Section :

Type of Section : Square

Width : 240 mm

Wall thickness : 8 mm

Reinforcement bars :

Number of re-bars :

- In the corner : 4

Diameter : 24 mm

- In the mid-size : None

Percentage of re-bars : 3.739 %

Concrete covering : 40 mm

Buckling length : 1.8 m

Material characteristics :

Steel section : 275 N/mm²

Reinforcement bars : 500 N/mm²

Concrete : 30 N/mm²

Eccentricity

(perp. to buckling axis) : 0 mm

Calculation of : Ultimate load

Fire duration : 90 min

Result :

NON-DIMENSIONAL SLENDERNESS : .2718

ULTIMATE LOAD : 618 kN

Validation POTFIRE

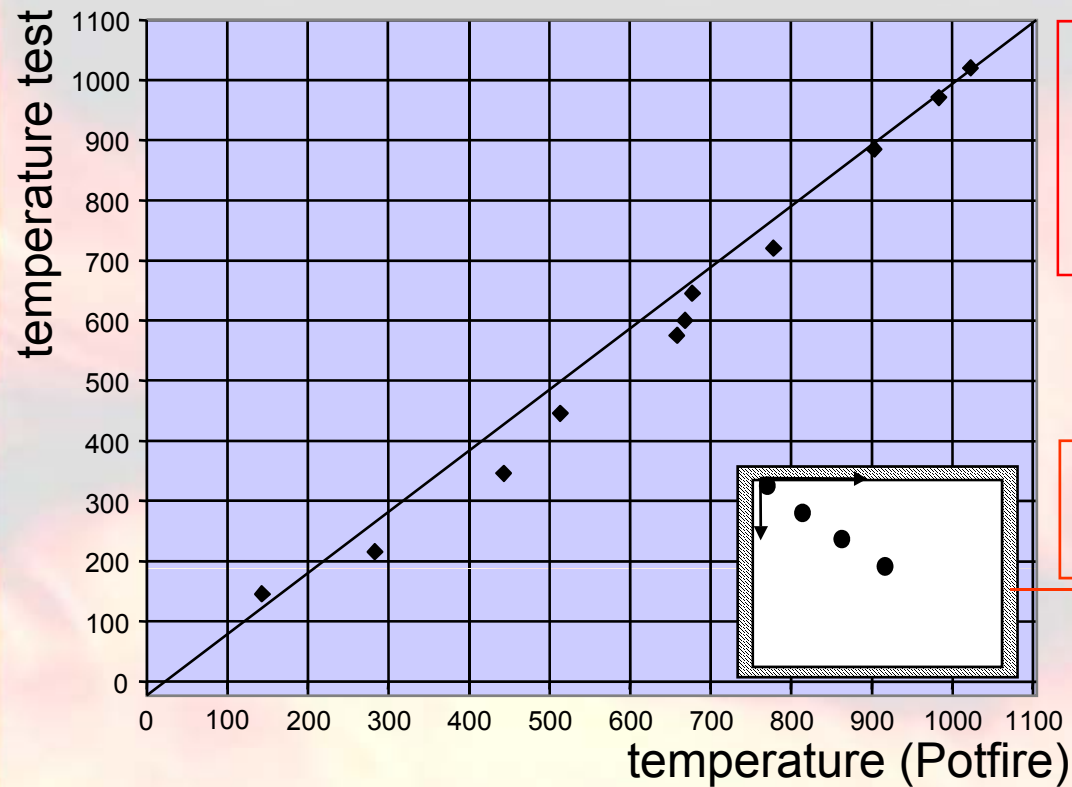

assumptions:

- $\alpha_{\text{conv}} = 25 \text{ W/m}^2\text{k}$

- $\epsilon_{\text{res}} = 0.7$

Concrete Filled Steel
Hollow Section

Composite elements

Evaluation thermal response

- Thermal response is relative complicated
- “Simple” verification rules are available*):
 - ✧ tabulated data
 - ✧ design graphs
 - ✧ special purpose computer programmes (e.g. POTFIRE)
- Alternative: “advanced” calculation models;
 - ✧ feasible for NFSC

*) “Simple rules” have a limited field of application!

National Annex to ČSN EN 1993-1-2 and ČSN EN 1994-1-2

ČSN EN 1993-1-2 (steel structures)

- Allows to choose parameters in 6 paragraphs
- The values from EN 1993-1-2 accepted without modification
- The only change is the critical temperature of thin-walled elements (see Part 3 for details)

ČSN EN 1994-1-2 (composite structures)

- Allows to choose parameters in 8 paragraphs
- The original values are accepted
- Allows to use European software without modifications

Thank you for your attention