

PART 1: Thermal & Mechanical Actions

O. Vassart, L.G. Cajot & M. Brasseur
ArcelorMittal, Esch/Alzette, Grand-Duchy of Luxembourg

M. Strejček
Czech Technical University in Prague, Czech Republic

ABSTRACT: The broad technical objective of this proposal is to disseminate effectively **Structural Fire Safety Engineering Knowledge**, gained in numerous ECSC funded projects during the last 25 years, into practical use. The aim is to this as widely as possible, in various countries and in the various national languages. The first part of this work is covered by Work Package 1, which describes the current tools for the determination of the **Thermal actions**, as they are implemented in the current the Eurocodes.

1 INTRODUCTION

In the sixties, a number of dramatic fires, such as the fire at the supermarket “Innovation” in Brussels which left more than 300 dead and the fire at the discotheque 'Le cinq Sept' in Saint-Laurent-du-Pont in France led to a lot of new regulations everywhere in Europe.

Current regulations deal with a number of areas, including:

- Means of escape
- Fire spread: including, "fire resistance" and "reaction to fire".
- The fire resistance of the structure in terms of resistance periods, R30, 60, 90 or 120.
- The smoke and heat exhaust ventilation system.
- Active fire fighting measures such as hand extinguishers, smoke detectors, sprinklers.
- Access for the Fire Brigade.

Even if the general context and general notions of fire safety are the same everywhere in Europe, the requirements are non-uniform. This was analysed in the frame of the project NFSC1 [11] and has been updated thanks to data gathered during the recent ECSC project “Risk Based Fire Requirements” [18]. For example for a single storey building, the fire resistance required is up to R120 in Spain but no fire resistance is required in Switzerland [18]. For a medium rise office building a Fire resistance R60 is required in the Netherlands compared to R120 in France [11]. The main parameters defining the requirements are the height of the building and the occupancy of the building related to the number of occupants and type of activities. Fire resistance requirements should be based on the parameters influencing fire growth and development. These include:

- Fire [probability of Fire occurrence, Fire spread, Fire duration, Fire load, Severity of fire...]
- Ventilation conditions
- Fire compartment (type, size, geometry)
- Type of the structural element
- Evacuation conditions
- Safety of the rescue teams
- Risk for the neighbouring buildings
- Active fire fighting measures

The current regulations do not take adequate account of the influence of sprinklers in suppressing or extinguishing the fire. The collected data in [11, 18] show that, except for very few cases, the present requirements are identical whether sprinklers are present or not. In order to consider all these physical factors in a systematic way, a more realistic and more credible approach to analyse structural safety in case of fire to include active fire fighting measures and real fire characteristics has been developed through different ECSC research projects and based on the “Natural Fire Safety Concept” [11, 12, 13, 18]. This methodology has been developed based on statistical, probabilistic and deterministic approaches and analysis. This method is applicable to all structural materials and buildings.

Figure 1.1 shows a comparison between the "natural" fire curves for different configurations (compartment size, fire loads, walls insulation, combustible characteristics,...) and the standard ISO-Fire curve.

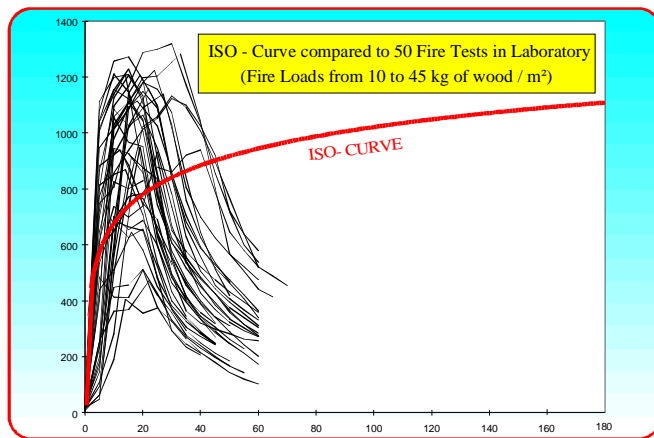

Figure 1.1 Temperature-time curves from natural fire and from ISO-Fire

This shows the difficulties to understand the behaviour of elements in case of real fires using data obtained according to the single ISO-Fire curve. A real fire has characteristics that are not taken into account in the standard ISO-Fire curve. The characteristics of a real fire are shown in Figure 1.2 and include:

- A smouldering phase: ignition and smouldering fire at very low temperature with a duration that is often difficult to estimate. This phase is not shown in Figure 1.2.
- A growing phase called pre-flashover (localised fire): the duration of this phase depends mainly on the characteristics of the compartment. The fire remains localised up to a possible flashover.
- A flashover: the flashover is a generalised fire. This phase is generally very short.
- A post flashover fire: this phase corresponds to a generalised fire for which the duration depends on the fire load and the ventilation.
- A decreasing phase: the fire begins to decrease until all the combustible materials have completely burnt.

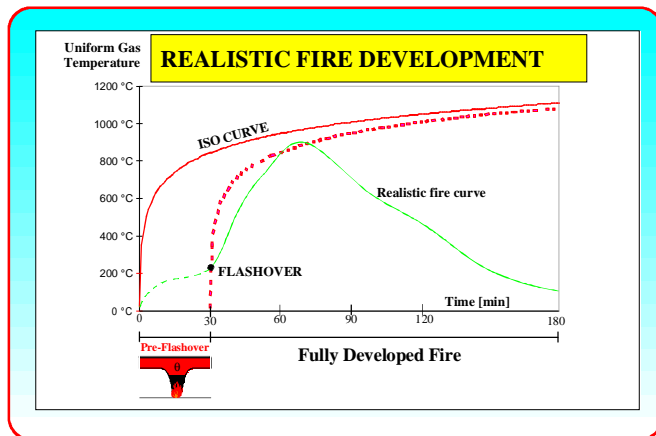

Figure 1.2 Natural fire phases

2 METHODOLOGY

2.1 Introduction

The determination of the fire development in a fire compartment requires knowledge of a large number of parameters. A number of these parameters are fixed by the characteristics of the building. Nevertheless, the main characteristic, the "fire load" is generally a function of the activity and may not be a constant during the life of the building. The fire load can be defined as a statistical distribution. For structural design at ambient temperature, the mechanical loads such as self-weight, imposed load and wind are also defined by a statistical distribution.

In the same way, the fire safety in a building has been determined through a probabilistic approach. In the global natural fire safety concept, the objective is defined by a target value of failure. The objective is not to change the safety level actually existing through the prescriptive codes but to quantify it through corresponding realistic failure probability or safety index. The combination of active and passive measures can be used to reach an acceptable level of safety.

The general method of safety quantification is based on the method used for structural design at ambient temperature and defines a design fire load taking into account the probability of fire occurrence and the influence of active fire fighting measures.

The design fire load is then used in the fire calculation models to assess the structural fire behaviour. Models to determine the temperature within the compartment are described here.

2.2 Objectives

The objective is to reach an acceptable safety level. This acceptable safety level can be defined by comparison to the other existing risks in life including the structural collapse of the building in normal conditions. The target probability to have a structural collapse in normal conditions is $7,23 \cdot 10^{-5}$ per building life [10]. The objective is: $P_f(\text{probability of failure}) \leq P_t(\text{target probability})$

As it is defined in the Eurocodes, the fire is an accidental action. A large statistical study has been realised in order to determine the probability to have a fire occurrence. This ignition is a function of the activity of the building. A good correlation between statistics coming from different European countries has been found [11]. When the fire has started, a collapse can occur only if the fire reaches severe conditions. It is necessary to define the probability that the fire grows to a severe fire. In this phase, the active measures, the occupants and the firemen have an important role to play. It means that in a large number of cases, this fire will be stopped very quickly, and will never grow. According to statistics, the actions of active measures and fire brigade intervention considered in the building have been assessed to determine the probability to have a severe fire. So according to the active (sprinkler, detection, ...) and passive (compartmentation) measures used in the building, the activity in the building and the fire brigade intervention, a design fire load is calculated from the target probability. This procedure is developed and detailed in the chapter 5.

2.3 Fire development calculation method

Different levels of fire development calculation methods exist:

- simple models: mainly the parametric fires
- zone-models: these models take into account all the main parameters controlling the fire
- field models: too complex for use as a general design tool. However field models are the only tools valid for sophisticated geometry [19].

The assumptions of the one-zone model are related to a generalised fire with uniform temperature in the compartment while the two-zone models are related to a stratified smoke layer from a localised fire.

The main parameter of the fire development is the rate of heat release (RHR). This rate of heat release is a function of compartment size and activity and a function of time. The fire is initially a localised fire in the pre-flashover phase. The beginning of this phase is characterised by a fire growth that has been quantified according to a t^2 -fire assumption. This means that the rate of heat release is defined by a parabolic equation. The buildings are classified into 4 categories according to the fire-spread velocity: low, medium, fast and ultra-fast. The rate of heat release will reach a maximum value corresponding to a steady state defined by fuel or ventilation control conditions.

One of the assessments is to know the RHR evolution and to define whether the fire will grow to a flashover or will remain a localised fire. When the conditions of flashover or generalised fire are not reached, a fire remains localised. In this condition, a two-zone model is used to estimate the general effect of the smoke layer. The local effect near the fire is also studied by empirical models developed in a previous research 'natural fire in large compartments' [8]. Hasemi [17] performed experimental investigations to determine the localised thermal actions from a fire, from which a simplified method was developed. The combination of both models allows the determination of the temperature field near and far away the fire.

2.4 Structural fire behaviour

According to this thermal action, the thermal transfer to the structural elements has to be calculated. The models of different levels can be used. From the temperature field in the structure and from the combination of the mechanical loads in case of fire, the structural behaviour can be assessed with models also having different levels.

Simplified models using element/element calculations can be applied. Generally this model is based on the notion of critical temperature. If the heated temperature is below the critical temperature there is no failure and if the heated temperature is higher than the critical temperature there is failure. It is a 'pass or failure' criterion. The objective is then reached if the time to reach the failure is greater than the required natural fire exposure.

More sophisticated models, for example using finite element calculations, can be used. The results of the model are generally in terms of deformation during the whole fire duration. In some cases, the performance criteria (to measure at which level the objectives are fulfilled) can be given in terms of deformation.

Knowledge of the structural fire behaviour allows for an assessment against a range of performance criteria in terms of limited deformation or structural damage.

The choice of performance for design purposes will be dependent on the consequences of failure and the function of the building. For certain high-profile multi-storey buildings this may mean that no structural failure must take place during the whole duration of the fire.

The characteristics of these models will be developed in the Work Package 3.

2.5 Required data

In order to apply this methodology, the characteristics of the building have to be known. This methodology is applied compartment by compartment. The compartment has to be defined in terms not only of the geometry, but also the thermal characteristics of the walls that are able to accumulate and to transfer a large part of the energy released by the fire, and the openings which allow the air

exchange with the outside of the compartment. Some rules and tables will be given in chapter 3 in order to determine all these data.

3 CHARACTERISTICS OF THE FIRE COMPARTMENT

3.1 Introduction

In the “Natural Fire Safety” approach, the fire safety design is based on physically determined thermal actions. In contrast with conventional design, parameters like the amount of fire load, the rate of heat release and the amount of ventilation play an important role in the natural fire design. In most buildings, the number of possible fire scenarios is infinite and need to be reduced. Only "credible worst case fire scenarios" will be studied. If the design fire scenarios are chosen, a number of fire models are available to calculate the thermal actions.

3.2 Boundary elements of the compartment

In the Natural Fire Safety Concept, the fire development is described in the fire compartment. The assumption is that the fire will not spread to other compartments. Whether this is true, depends on the fire behaviour of the boundary constructions (floors, wall [including doors], etc.).

It is necessary to understand this behaviour in order to assess their capability to function as fire barriers. The following options are available:

- Ad-hoc tests: the element can be exposed to a temperature-time curve in a furnace as calculated with fire models based on the worst-case fire scenarios.
- Expert judgement: this approach makes use of the available test-data of ISO-resistance tests on separating elements
- Direct use of ISO-requirements: national rules define fire compartments with ISO-fire resistance for walls, ceilings, doors and floors, depending on the use and the geometry of the building.

The first two options can be used for a limited number of separating elements, and will lead to high costs. In practice, often the 3rd option has to be used.

3.3 Wall: thermal characteristics

The heat loss from the compartment is an important factor for the temperature determination. Heat losses to the compartment boundaries occur by convection and radiation. The thermal properties of the walls have to be known.

The three main parameters characterising the thermal properties of a material are:

- heat capacity c_p
- density r
- conductivity I

The conductivity and the heat capacity depend on temperature.

In simplified models, only the thermal inertia, called b -factor, is used. The b -factor is determined by the following equation (3.1) from the thermal properties:

$$b = \sqrt{I \cdot r \cdot c_p} \quad (3.1)$$

- For the calculation of the b factor, the density r , the specific heat capacity c_p and the thermal conductivity I of the boundary may be taken at ambient temperature [1].

In case of multi-material walls, it is suggested to deduce the b -factor from the following method:

- When a material (2) is insulated by a heavy material (1), so $b_1 < b_2$, the b -factor is the b -factor from the material 1: $b = b_1$.
- in the opposite, if $b_1 > b_2$, we can define a limit thickness for the material 1 equal to (3.2):

$$S_{1,lim} = \sqrt{\frac{t_d I_1}{c_1 r_1}} \quad \text{where } t_d \text{ is the time of the fire up to the decrease phase.} \quad (3.2)$$

Then the b-factor is determined by:

If $s_1 > s_{1,lim}$ then $b = b_1$

$$\text{If } s_1 < s_{1,lim} \text{ then } b = \frac{s_1}{s_{1,lim}} b_1 + \left(1 - \frac{s_1}{s_{1,lim}}\right) b_2$$

The table 3.1 gives the thermal characteristics of the most commonly used materials for different temperatures.

Table 3.1 Thermal material characteristics

material	Temperature	l (W/m/K)	r (kg/m ³)	c_p (J/kg°K)
Normal weight concrete	20	2	2300	900
	200	1,63	2300	1022
	500	1,21	2300	1164
	1000	0,83	2300	1289
Light weight concrete	20	1	1500	840
	200	0,875	1500	840
	500	0,6875	1500	840
	1000	0,5	1500	840
Steel	20	54	7850	425
	200	47	7850	530
	500	37	7850	667
	1000	27	7850	650
Gypsum insulating	20	0,035	128	800
	200	0,06	128	900
	500	0,12	128	1050
	1000	0,27	128	1100
Sealing cement	20	0,0483	200	751
	250	0,0681	200	954
	500	0,1128	200	1052
	800	0,2016	200	1059
CaSi board	20	0,0685	450	748
	250	0,0786	450	956
	450	0,0951	450	1060
	1050	0,157	450	1440
Wood	20	0,1	450	1113
	250	0,1	450	1125
	450	0,1	450	1135
	1050	0,1	450	1164
Brick	20	1,04	2000	1113
	200	1,04	2000	1125
	500	1,18	2000	1135
	1000	1,41	2000	1164
Glas	20	0,78	2700	840

3.4 Opening characteristics

Openings in an enclosure can consist of windows, doors and roof vents. The severity of the fire in an enclosure depends on the amount of openings in the enclosure.

Concerning the opening factor O used in simplified models, it is defined according the equation (3.3) for a single vertical opening:

$$O = A_w \sqrt{H} \tag{3.3}$$

When several vertical openings have to be considered, the global area and an equivalent height have to be used. They are determined by equations (3.4) and (3.5):

$$A_w = \sum A_{wi} \quad (3.4)$$

$$H = \left[\frac{\sum A_{wi} \sqrt{H_i}}{\sum A_{wi}} \right]^2 \quad (3.5)$$

where A_w is the opening area, H the opening height and i is relative to the opening n° .

3.5 Mechanical ventilation

The use of pressurisation is an interesting way of protection for staircases.

The **mechanical ventilation** is also often used for smoke and **heat exhaust ventilation system** (SHEVS).

4 CHARACTERISTICS OF THE FIRE

It is the aim of this chapter to provide all the information needed by a designer when he faces a fire problem. The first data necessary to design a building against fire is to define the energy that is going to affect the structure. A way of knowing it would be to perform a real fire test in the building. This is uneconomic and besides would only provide information for one of the multiple fires that could happen in the building. Information from fire tests, existing models and fire dynamics have been combined so that a characterisation of the fire for different cases can be obtained.

4.1 Fire load

The first problem is to know which is the fire load to be considered in design. It is very rare that the fire load is known in a deterministic way. Generally it must be defined in a statistical way.

4.1.1 Deterministic approach

The fire load Q in a fire compartment is defined as the total energy able to be released in case of fire. Part of the total energy will be used to heat the compartment (walls and internal gas), the rest of the energy will be released through openings. Building components such as wall and ceiling linings, and building contents, such as furniture, constitute the fire load. Divided by the floor area, the fire load Q gives the fire load density q_f .

In EC 1, the characteristic fire load density is defined by the equation (4.1):

$$q_f = \frac{1}{A_f} \sum_i (Y_i \cdot m_i \cdot H_{ui} \cdot M_i) \quad (4.1)$$

where:

M_i = the mass of the material i (kg)

H_{ui} = the net calorific value of the material i (MJ/kg) (see Table 4.1)

m_i = the factor describing the combustion behaviour of the material i

Y_i = the factor of assessing protected fire load of the material i

A_f = the floor area of the fire compartment (m^2)

$H_{ui} \cdot M_i$ represents the total amount of energy contained in material i and released assuming a complete combustion. The 'm' factor is a non-dimensional factor between 0 and 1, representing the combustion efficiency : $m = 1$ corresponds to complete combustion and $m = 0$ to the case of materials that do not contribute to the fire at all.

A value of $m = 0,8$ is suggested for standard materials. For wood, a value of 17,5 MJ/kg is suggested for H_u leading to 14 MJ/kg for (mH_u).

Table 4.1 Recommended net calorific value of combustible materials H_u (MJ/kg) for fire load calculation.

Solids	
Wood	17,5
Other cellulosic materials <ul style="list-style-type: none"> • Clothes • Cork • Cotton • Paper, cardboard • Silk • Straw • Wool 	20
Carbon <ul style="list-style-type: none"> • Anthracit • Charcoal • Coal 	30
Chemicals	
Paraffin series <ul style="list-style-type: none"> • Methane • Ethane • Propane • Butane 	50
Olefin series <ul style="list-style-type: none"> • Ethylene • Propylen • Butene 	45
Aromatic series <ul style="list-style-type: none"> • Benzene • Toluene 	40
Alcohols <ul style="list-style-type: none"> • Methanol • Ethanol • Ethyl alcohol 	30
Fuels <ul style="list-style-type: none"> • Gasoline, petroleum • Diesel 	45
Pure hydrocarbons plastics <ul style="list-style-type: none"> • Polyethylene • Polystyrene • Polypropylene 	40
Other products	
ABS (plastic)	35
Polyester (plastic)	30
Polyisocyanerat and polyurethane (plastics)	25
Polyvinylchloride, PVC (plastic)	20
Bitumen, asphalt	40
Leather	20
Linoleum	20
Rubber tyre	30
NOTE The values given in this table are not applicable for calculating energy content of fuels.	

4.1.2 Statistical approach

The fire load density can be estimated by summing all the fire loads present in a building: it is a deterministic approach. Some information is available on the fire load density for specific building types such as offices and schools. This statistical approach is only valid for building types where similar amounts of fire load can be expected. In those cases the fire load density can be given as a statistical distribution with a mean value and a standard deviation.

In the next table for a number of building types these values are given. The values are based on the Gumbel type I distribution. The values (for 80, 90 and 95% fractiles) are calculated using this distribution, assuming a variation coefficient of 0,3. These values of table 4.2 are derived from a compendium of commonly accepted values extracted from international documents [2, 21, 22].

Table 4.2 Data on fire load density for different buildings [MJ/m²]
(Fitting with a Gumbel type I distribution).

	Stand. Deviation	Mean	80% fractile	90 % fractile	95 % fractile
Dwelling	234	780	948	1085	1217
Hospital	69	230	280	320	359
Hotel (room)	93	310	377	431	484
Library	450	1500	1824	2087	2340
Office (standard)	126	420	511	584	655
School	85,5	285	347	397	445
Shopping centre	180	600	730	835	936
Theatre (cinema)	90	300	365	417	468
Transport (public space)	30	100	122	139	156

4.2 Type of fire

Another question to be answered is what amount of the total fire load is going to burn in case of fire and how will this affect the Temperature-time curve occurring in the scenario.

Fires never (except for arson or explosion, which are not in the scope of the research) start at the same time in a whole fire compartment. They always start as a localised fire that, depending on a series of conditions, will develop to a major fire.

Main differences between a localised and a fully developed fire are listed in Table 4.3

Table 4.3 Differences between localised and fully engulfed fires

	Fire load	Gas temperature
Localised fire	Only a part of the compartment is in fire	Two zones (two temperature-time curves)
Fully developed fire	The fire load uniformly distributed in the whole compartment is in fire	One zone (one temperature-time curve)

In situations in which the whole compartment is involved in the fire, a uniform gas temperature is assumed. In a fully developed fire all fire load is burning so that the whole compartment is filled with smoke, combustion products and air that mix so well that the gas in the whole compartment can be considered homogeneous and represented by a single temperature. A method that allows for determining the Temperature-time curve(s) (T-t) to be used for the structural behaviour in case the fire is localised or fully developed is described in details in chapter 6.

4.3 Design fire

Once the fire load has been characterised it must be known at which rate the fire load will burn. This will lead to the RHR.

4.3.1 Fuel control and ventilation control fires

The fire load defines the available energy but the gas temperature in a fire depends on the Rate of Heat Release. The same fire load burning very quickly or smouldering can lead to completely different gas temperature curves.

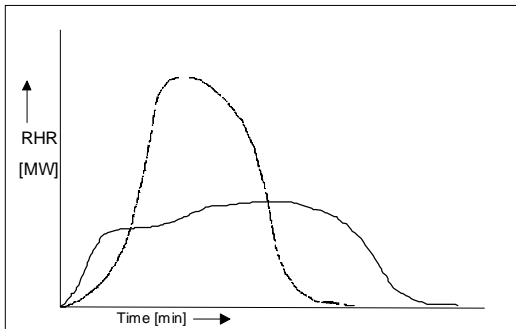

Figure 4.1 Two RHR curves corresponding to the same amount of fire load, as the surface beneath both curves is the same.

The RHR is the source of the gas temperature rise, and the driving force behind the spreading of gas and smoke. A typical fire starts small and goes through a growth phase. Two things can then happen depending whether during the growth process there is always enough oxygen to sustain combustion. Either, when the fire size reaches the maximum value without limitation of oxygen, the RHR is limited by the available fire load (**fuel controlled fire**).

Or if the size of openings in the compartment enclosure is too small to allow enough air to enter the compartment, the available oxygen limits the RHR and the fire is said to be **ventilation controlled**. Both ventilation and fuel-controlled fires can go through flashover.

This important phenomenon, flashover, marks the transition from a localized fire to a fire involving all the exposed combustible surfaces in the compartment. The two regimes are illustrated in Figure 4.2, which presents graphs of the rate of burning vs. the ventilation parameter $A_w \sqrt{h}$, with A_w being the opening area and h being the opening height. Graphs are shown for different fire load densities. Starting on the left side of the figure in the ventilation controlled regime, with increasing ventilation parameter the rate of burning grows up to the limiting value determined by the fire load density and then remains approximately constant (fuel controlled region).

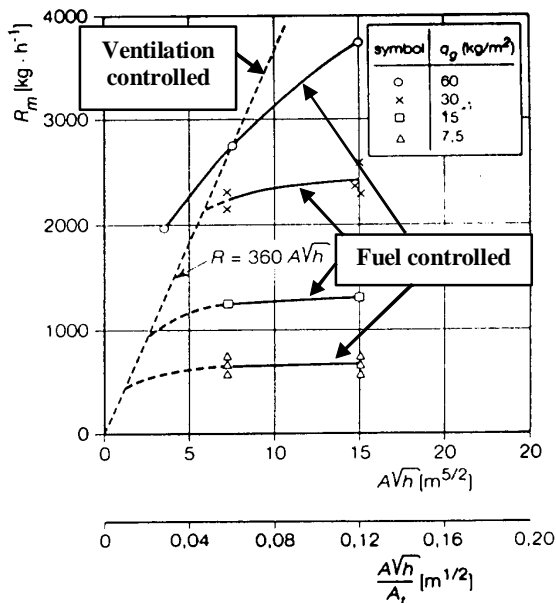

Figure 4.2 Mass rate for different fire load densities.

4.3.2 DESIGN RHR

The rise of the rate of heat release to the maximum value (see Figure 4.3) is given by (4.2):

$$RHR = (t / t_{\alpha})^2 \quad (4.2)$$

where:

RHR = Rate of heat release of the fire during growth phase (MW)

t = time (s)

t_{α} = time constant given in Figure 4.4 (s)

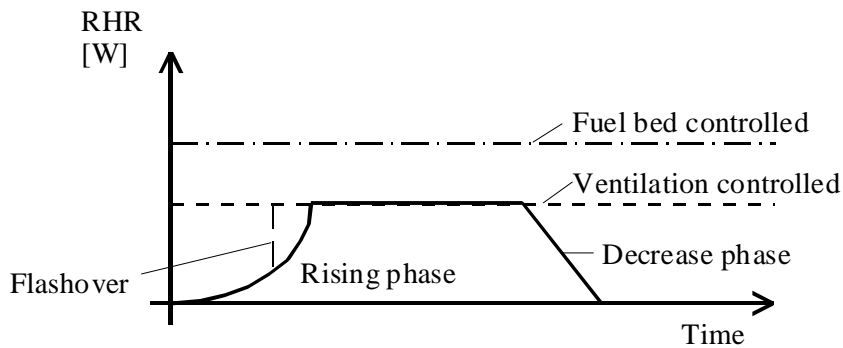

Figure 4.3 Rate of Heat Release in function of Time

Three phases are recognised, rise, stationary (post flashover) and decrease.

The fire growth parameter given in the code [1, 2] varies according to building types and some guidance towards the classification and determination of this parameter is shown in Figure 4.4.

After the growing phase, the RHR curve follows an horizontal plateau with a maximum value of RHR corresponding to fuel bed (see figure 4.4) or ventilation controlled conditions.

In [1, 2] and [7] this decay phase is assumed to show a linear decrease of the RHR. Formulae are given to calculate the time of commencement of the decay period and the duration of the decay period. Based on test results, the decay phase can be estimated to start when approximately 70% of the total fire load has been consumed.

In the following Figure 4.4 the proposal for the RHR curve for the NFSC project is given. The curve includes the growing phase, steady state and the decay phase.

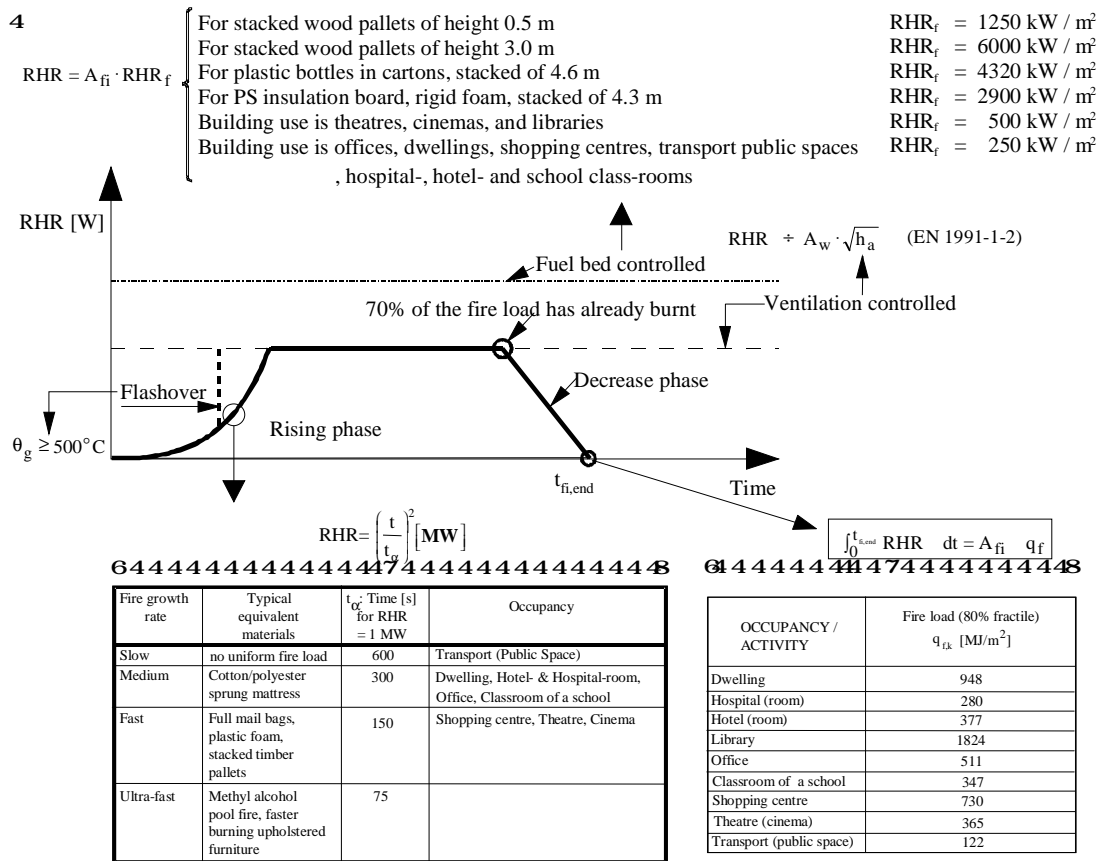

Figure 4.4 Design RHR curve [1]

4.3.3 Experimental data

Another way to obtain the *RHR* curve is to make a test. Techniques for measuring heat release rates (except in a calorific bomb) were not available until a few years ago, when the principle of oxygen depletion calorimetry was developed. Earlier attempts required the direct measurement of sensible enthalpy, which is very difficult to do correctly. The oxygen depletion technique, however, has enabled these measurements to be made easily and with good accuracy. The oxygen consumption principle states that, within a small uncertainty band, the heat released from the combustion of any common combustible is uniquely related to the mass of oxygen removed from the combustion flow stream [6]. This technique has been used and database of test results established. Different sources are available in the literature to extract data for the value of *RHR* [3,4,5,6].

The Hazard [5] two-zone simulation model within its framework contains a database where various items are laid out and information on their *RHR* among other things is given. These items tend to be only items found in the home, such as chairs, TV's and Christmas trees. This obviously leads to a limitation in the field of use. Although in its particular region of use, it appears to be a very good source of information, since it includes every phase during a *RHR* curve. Argos [4] is another database found within the framework of a fire simulation programme. In Argos, different equations are given for solid material fires, melting material fires, liquid fire and smouldering fires. These equations define the *RHR* as a function of the fire spread velocity in the horizontal and vertical directions. The numerical values valid for different materials and objects are given in the Argos database.

Another source of test result information is the "Initial Fires" document compiled by the University of Lund [3]. This has the same format as the Hazard database but contains more results. In this document one can find information not only on household objects but also objects such as various vehicle types. CTICM in France has performed fire tests on new cars (fabricated in 1996) [9], on hotel rooms and on real furniture and measured the *RHR*. These experimental data are very interesting, because the majority of fire tests reported in the literature have been performed with wood cribs as fuel.

5 PROBABILISTIC ASPECT

5.1 Introduction

The probability that a fire breaks out in a swimming pool is obviously much lower than in a painting workshop. The probability that this fire spreads and leads to a fully engulfed compartment depends on the compartment area and on the active fire fighting measures such as sprinklers, automatic fire detection by smoke or heat, automatic alarm transmission to fire brigade and fire brigade intervention. Different ECSC research projects [11, 18] have enabled to gather statistics and to deduce the probability that:

- a fire starts
- the occupants fail to extinguish the fire
- the automatic active measures (sprinklers...) fail to extinguish the fire
- the fire brigade fail to extinguish the fire

The probability of successful intervention by the fire brigade depends mainly on the time to detect the fire (automatic fire detection by smoke or heat) and the time to reach the building (automatic transmission of the alarm and distance from fire brigade to building).

From those probabilities it is possible to deduce $g_{q,f}$ factor on the fire load by a procedure based on the Annex C of prEN 1990 [10] and reliability calculations. This procedure is summarised in chapter 5.4.

This factor $g_{q,f}$ has been divided into sub-coefficients d_{q1} , d_{q2} , d_{ni} to take into account the compartment size, the building type and the different active fire fighting measures. The characteristic fire load $q_{f,k}$ has to be multiplied by $\gamma_{qf} = d_{q1} \times d_{q2} \times d_{ni}$ to obtain the design fire load $q_{f,d}$.

The design fire load, $q_{f,d}$ is then used by the “Natural Fire Models” tools (see following chapter 6) to calculate the design natural fire heating.

5.2 Statistics

This statistical study has been based on data [11] from

- Switzerland : detailed information and analysis of all fires (± 40.000 fires) causing damage larger than 1.000.000 CHF in Bern from 1986 to 1995
- France: fires in industrial buildings occurring between January 1983 to February 1984, all fire brigade intervention in 1995 (3.253.855 interventions of which 312.910 were for fires).
- The Netherlands: fires in industrial buildings occurring between January 1983 to January 1985.
- Finland: all the building fires in 95 (2.109 fires for a total number of buildings of 1.150.494).
In the scope of [18] additional results for Finland, based on combining the information in the national fire statistics database “PRONTO” of the Ministry of Interior and other relevant national statistical database, have been added for the year 1996-1999.
- The Luxembourg fire brigade reports for 1995 and 1997

and international data from different sources on various aspects of fire safety namely sprinkler performance. Database on the effects of sprinklers were summarised or collected from USA, Finland, Germany, France, Australia and UK [13].

The following statistics concern mainly dwellings, offices and industrial buildings and have been adopted for developing the procedure. This procedure has been extended to other activities by the coefficient δ_{q1} given in table 5.6.

5.3 Probabilities

5.3.1 Event tree analysis

An event tree (see Figure 5.1) may be established from fire start to describe fire growth, using recommended default values from Table 5.1.

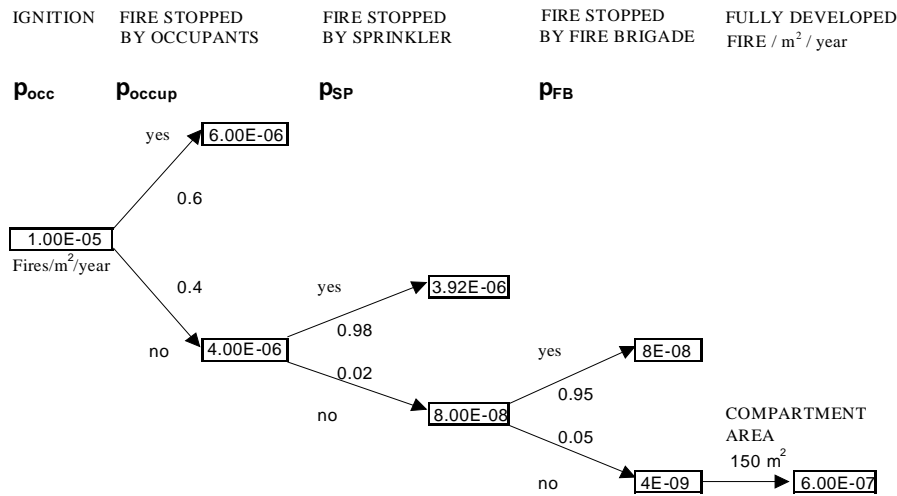

Figure 5.1 Example for an event tree for fire growth in an office with a compartment area of 150 m²

Table 5.1: Event tree factors

		Dwelling	Office	Industrial
Fire occurrence [1/(m ² .year)]	p_{occ}	$30 \cdot 10^{-6}$	$10 \cdot 10^{-6}$	$10 \cdot 10^{-6}$
Fire stopped by occupant	p_{occup}	0,75	0,60	0,45
Fire stopped by sprinkler system	p_{SP}	see Table 5.5		
Fire stopped by standard fire brigade	p_{FB}	0,90 - 0,95	0,90 - 0,95	0,80 - 0,90

5.3.2 Fire occurrence and fire growth

The probability of a severe fire per year able to endanger the structural stability may be expressed as (5.1):

$$p_{fi} = p_1 \cdot p_2 \cdot p_3 \cdot A_{fi} \cdot p_4 \quad (5.1)$$

with:

p_1 : probability of severe fire including the effect of occupants and standard public fire brigade (per m² of floor and per year)

p_2 : additional reduction factor depending on the fire brigade types and on the time between alarm and firemen intervention

p_3 : reduction factor if automatic fire detection (by smoke or heat) and / or automatic transmission of the alarm are present

p_4 : reduction factor if sprinkler system is present (p_4 is also the probability of failure of sprinkler in stopping the fire)

A_{fi} : surface area of the fire compartment

Note: The factor p_1 includes the actions of the occupants and the public fire brigade in preventing a fire to grow into a severe fire and is not to be mistaken as the frequency of fire occurrence.

The influence of fire brigade types, time between alarm and firemen intervention, automatic detection and automatic alarm transmission (p_2 , p_3) has not been considered in the Table 5.1, p_1 of Table 5.2 is in fact $p_{occ} \cdot (1 - p_{occup}) \cdot (1 - p_{FB})$.

Accordinging [11, 18], the following values are recommended for p_1 , p_2 , p_3 and p_4 .

Table 5.2 Frequency of fire start and growth to severe fire including standard public fire brigade

Occupancy/Activity	p_1 [$10^{-7}/(\text{m}^2 \cdot \text{year})$]
Office	2 – 4
Dwelling	4 – 9
Industrial	5 – 10

Table 5.3 Additional reduction factor depending on the fire brigade type and on the time between alarm and firemen intervention

p_2	Time between Alarm and Action of the FIREMEN		
	$\leq 10'$	$10' < t \leq 20'$	$20' < t \leq 30'$
Type of FIREMEN			
Professional	0,05	0,1	0,2
Not-Professional	0,1	0,2	1

Table 5.4 Reduction factor for automatic fire detection (by smoke or heat) and automatic transmission of the alarm

Active Measures	p_3
Detection by smoke	0,0625
Detection by Heat	0,25
Automatic Alarm transmission to Fire Brigade	0,25

Table 5.5 Reduction factor for sprinkler system

Type of sprinkler	p_4
Normal (e.g. according to the regulations)	0,02
High standard (e.g. electronically checked valve, two independent water sources)	0,01 - 0,005
Low standard (e.g. not according to the regulations)	$\geq 0,05$

5.4 Procedure

5.4.1 Determination of the design values of actions and resistances - Safety factor g in the Eurocodes - Principle for normal conditions of use

The resistance R and the Action S are according to statistical distributions, which are defined by the standard deviations (s_S, s_R) and the means (m_S, m_R). To ensure a sufficient safety, it is necessary that the failure ($S > R$) occurs only with a very low probability p_f represented given by the hatched area (see Figure 5.2). This area can be measured by the safety index b .

The Eurocodes in normal conditions require a maximum failure probability p_f of $7,23 \cdot 10^{-5}$ for the building life, which corresponds to a safety index b_f of 3,8.

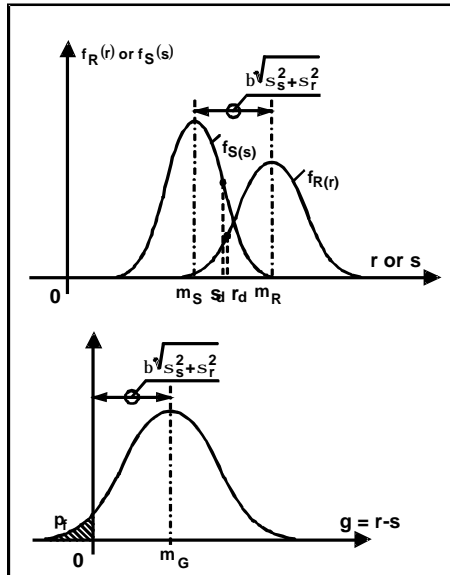

Figure 5.2 Probabilistic approach

$$p_f \leq p_t (= 7,23 \cdot 10^{-5}) \rightarrow b > b_t (= 3,8)$$

$$m_R - m_S \geq b \sqrt{s_S^2 - s_R^2} = b \frac{s_S^2 - s_R^2}{\sqrt{s_S^2 - s_R^2}}$$

$$6444174448 \quad 6444174448$$

$$\Rightarrow m_R - \frac{s_R}{\sqrt{s_S^2 - s_R^2}} b s_R \geq m_S - \frac{s_S}{\sqrt{s_S^2 - s_R^2}} b s_S$$

$$\Rightarrow r_d \geq s_d$$

For the two variables S and R, corresponding to action and resistance, the design values are given respectively by s_d and r_d .

However, there are a lot of actions: (self weight, variable load, snow, wind, earthquake, fire..) and a lot of resistances (compressive strength of concrete, yield point of the steel of the profiles, of rebars,...)

Therefore the problem is much more complex than the comparison between two statistical variables. That's why the Eurocodes have adopted a semi-probabilistic approach based on the FORM method (First Order Reliability Method).

This simplification of the Eurocodes consists of assuming:

$$a_R = \frac{s_R}{\sqrt{s_R^2 + s_S^2}} = 0,8 \text{ for the resistance.} \quad (5.2)$$

$$a_S = \frac{s_S}{\sqrt{s_R^2 + s_S^2}} = (-0,7) \text{ for the main action and } (-0,28) \text{ for the secondary action} \quad (5.3)$$

$$\Rightarrow s_{d,i} = \text{Design Value} = m_{S,i} + 0,7 b s_{S,i}$$

$$\Rightarrow r_{d,i} = \text{Design Value} = m_{R,i} - 0,8 b s_{R,i}$$

By considering constant values for the weighing factors $a_{s,i}$, the design values $s_{d,i}$ for actions can be defined without referring to the resistance, as these design values depend only on the safety index β , on the mean and the standard deviation of the corresponding statistical distribution and, of course, on the type of the distribution (see formulae of Figure 5.2 [10]).

These design values $s_{d,i}$ of the actions are thus the values of the actions which have to be considered in order to obtain the required safety. If β is equal to 3,8 as in the Eurocodes, this implies that the failure risk is equal to $7,23 \cdot 10^{-5}$ during the building life.

As a consequence, for each action, it is possible to define safety coefficient g , which is the ratio between the design value s_d and the characteristic value, which is the usual reference value:

$$g = \frac{s_d}{s_k} \quad (5.4)$$

In this way we can find the safety coefficients given in the Eurocodes: on the action side 1,35 and 1,5 for the self-weight and the imposed loads; on the resistance side 1,0, 1,15 and 1,5 for respectively structural steel, reinforcement bars and concrete [1, 16, 20, 24].

Hereafter the calculation of the γ_s of 1,15 for rebars is given as an example [20]:

- $\beta = 3,8$; $a_a = 0,8$
- Statistical law : Lognormal
- Variation coefficients $\left(= \frac{s}{m} \right)$:
 - $V_R =$ variation coefficient for the Design Value $= \sqrt{V_G^2 + V_m^2 + V_f^2} = 0,087$
 - $V_m =$ variation coefficient for Model uncertainty $= 0,05$
 - $V_G =$ variation coefficient for Geometry of element $= 0,05$
 - $V_f =$ variation coefficient or mechanical property $= 0,05$
- Design value : $X_d = m_X \exp(-a_R b V_R)$
 $= m_X \exp(-0,8 b V_R)$
- Characteristic value : $X_k = m_X \exp(-k V_f)$
 with $k = 1,645$ corresponding to the 5 % fractile
- Safety Factor : $g_s = \frac{X_k}{X_d} = \exp(0,8 b V_R - k V_f)$
 $= \exp(0,8 \cdot 3,8 \cdot 0,087 - 1,645 \cdot 0,05)$
 $= 1,198$

5.4.2 Target value

The assumption of a target failure probability p_t of $7,23 \cdot 10^{-5}$ per building life ($1,3 \cdot 10^{-6}$ per year) is defined in EN 1990 [10]. That safety requirement ($b > 3,8$) for ultimate limit state in normal conditions has also been adopted as the acceptance criteria for the structural fire resistance. In fact, the required safety in case of fire could be differentiated. This idea has been developed in the final report of [11] (chapter 2.8 of the Annex B of WG5 part), where it is proposed to use a target failure probability p_t [1/year] depending on the people evacuation:

$p_t = 1,3 \cdot 10^{-4}$ for normal evacuation p_t [1/year]

$p_t = 1,3 \cdot 10^{-5}$ for difficult evacuation (hospitals, etc.)

$p_t = 1,3 \cdot 10^{-6}$ for no possible evacuation (e.g. high rise building).

It might lead to future interesting improvements but it was decided to keep the value of EN 1990 [10] accepted by everybody whereas discussions should be needed to convince the Authorities to adopt lower new target values.

5.4.3 Fire design and conditional probability

The Annex C of EN 1990 [10], which describes the semi-probabilistic concept leading to the design values for the actions and for the material properties, has been extended to the structural fire resistance.

At room temperature, the safety factors for the actions $g_{s,i}$ and the material properties $g_{R,i}$ have been deduced by a semi-probabilistic approach which assumes implicitly that the failure probability of the structure p_f is lower than a target failure probability p_t of $7,23 \cdot 10^{-5}$ per working life of the building, which is equivalent to a safety factor b of 3,8:

$$p_f \text{ (failure probability)} \leq p_t \text{ (target probability)} \quad (5.5)$$

In case of fire, the main action is the fire, which can be quantified by the fire load expressed in kg of wood or in MJ. However, this fire load becomes a real action for the structure only when there is a fire.

The fire load influences the structure only with a certain probability p_{fi} , p_{fi} being the product of p_{start} (probability that a fire starts) and p_{spread} (probability that this starting fire turns to a flash-over or a fully engulfed fire compartment).

In case of fire which is considered as an accidental action the equation (5.5) becomes:

$p_{f,fi}$ (failure probability in case of fire) · p_{fi} (probability of fire) ≤ p_t (target probability),
which can be written:

$$\begin{aligned} - & p_{f,fi} \leq (p_t/p_{fi}) \\ - & p_{f,fi} \leq p_{t,fi} \quad \Rightarrow \quad b_{f,fi} \geq b_{fi,t} \end{aligned} \quad (5.6)$$

Whereas the target value p_t of $7,23 \cdot 10^{-5}$ leads to the constant safety index b_t at room temperature, there is not in case of fire a fixed value of the safety index (called $b_{fi,t}$ in case of fire) because the target value $p_{t,fi}$ depends through equation (5.6) of the probability of fire p_{fi} . Knowing $b_{fi,t}$, the design value of the fire load can be deduced as explained hereafter.

5.4.4 Design fire load and d factor

Reliability calculations (see chapter 7.4 of [11]) have showed that the weighing factor for the main action at room temperature is strongly reduced in case of fire and may therefore be considered as a secondary action whereas the fire load becomes the main action.

Moreover these calculations have pointed out that the assumption of the weighing factor of (-0,7) for the main action has to be modified and that a value of (-0,9) should be chosen for α_{qf} .

According to the fire load densities given in the U.K. document "The Application of Fire Safety Engineering Principles to the Safety in Buildings" [14] and Prof. Fontana's analysis [15], the data of fire loads fit well into a Gumbel type I distribution. A variation coefficient V_{qf} of 0,3 has been chosen [11].

According to [10], the design value (see variable loads) for the Gumbel distribution is given by:

$$q_{f,d} = m_{qf} \left\{ 1 - \frac{\sqrt{6}}{p} V_{qf} \left[0,577 + \ln(-\ln F(0,9 b_{fi,t})) \right] \right\} \quad (5.7)$$

with m_{qf} the mean value of the fire load and ϕ the distribution function of the normal distribution.

As proposed in [16], a safety factor for the model for calculating the action effect $\gamma_{SD} = 1,05$ has been considered.

By choosing a characteristic value $q_{f,k}$ of 80 % fractile (see Annex E of EN 1991-1-2 [1] and [11]), the factor δ_{qf} becomes:

$$\begin{aligned} d_{qf} = \frac{q_{f,d}}{q_{f,k}} &= 1,05 \frac{\left\{ 1 - \frac{\sqrt{6}}{p} V_{qf} \left[0,577 + \ln(-\ln F(0,9 b_{fi,t})) \right] \right\}}{\left\{ 1 - \frac{\sqrt{6}}{p} V_{qf} \left[0,577 + \ln(-\ln 0,8) \right] \right\}} \\ &= 2,38 \text{ for } b = 3,8 \text{ and } 0,82 \text{ for } b = 0 \end{aligned} \quad (5.8)$$

The evolution of d_{qf} as a function of $b_{fi,t}$ is given by the Figure 5.3.

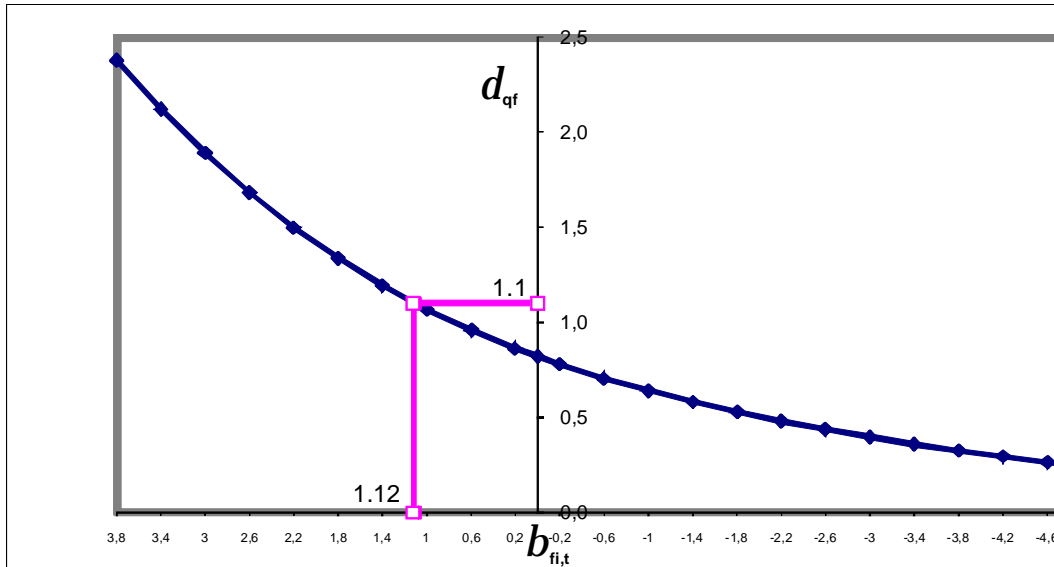

Figure 5.3 Safety factor δ_{qf} as a function of b_{fi}

The safety index $\beta_{fi,t}$ can be calculated from the probability of severe fire p_{fi} by the following formula :

$$b_{fi,t} = f^{-1} \left(\frac{p_t}{p_{fi}} \right) = f^{-1} \left(\frac{7,23 \cdot 10^{-5}}{p_{fi}} \right)$$

f^{-1} is the inverse of the cumulative Standard Normal Distribution

The Figure 5.3 enables then to deduce the factor δ_{qf} for the fire load.

This global procedure implies:

- to determine the probability to have a severe fire p_{fi}
- to calculate (p_t/p_{fi})
- to deduce the target reliability index $b_{fi,t}$
- to obtain the factor d_{qf}

This approach has been differentiated by splitting the factor δ_{qf} into 3 coefficients δ_{q1} , δ_{q2} and δ_{ni} to consider the influence on p_{fi} of respectively the compartment size, the risk of fire activation and the active fire fighting measures (see table 5.6).

Table 5.6 Resuming table of δ factors [1]

Compartment floor area A [m ²]	Danger of Fire Activation d_{q1}	Danger of Fire Activation d_{q2}	Examples of Occupancies
25	1,10	0,78	artgallery, museum, swimming pool
250	1,50	1,00	residence, hotel, office
2500	1,90	1,22	manufactory for machinery & engines
5000	2,00	1,44	Chemical laboratory Painting workshop
10000	2,13	1,66	Manufactory of fireworks or paints

d_{ni} Function of Active Fire Safety Measures									
Automatic Fire Suppression		Automatic Fire Detection			Manual Fire Suppression				
Automatic Water Extinguishing System	Independent Water Supplies	Automatic fire Detection & Alarm		Automatic Alarm Transmission to Fire Brigade	Work Fire Brigade	Off Site Fire Brigade	Safe Access Routes	Fire Fighting Devices	Smoke Exhaust System
d_{n1}	0 1 2 d_{n2}	by Heat d_{n3}	by Smoke d_{n4}	d_{n5}	d_{n6}	d_{n7}	d_{n8}	d_{n9}	d_{n10}
0,61	1,0 0,87 0,7	0,87 or 0,73		0,87	0,61 or 0,78		0,9 or 1 1,5*	1,0 1,5*	1,0 1,5*

* For normal fire fighting measures, which should be almost always present, such as the Safe Access the Fire Fighting Devices and the Smoke Exhaust System in staircases, the d_{ni} should be taken as 1,5 in case those measures either are unsatisfactory either are not

When the factors d_{q1} , d_{q2} and d_{ni} are determined, the design fire load $q_{f,d}$ can be deduced :

$$q_{f,d} = d_{q1} \cdot d_{q2} \cdot d_{ni} \cdot q_{f,k}$$

The design fire load is then used by the tools presented in chapter 6.

6 FIRE DEVELOPMENT CALCULATIONS

Introduction

When simulating numerically the fire development, different simplifications of the fire dynamics can be made. The present chapter will explain the models to apply in pre-flashover situation (the models of localised fire and 2 zone models) and in post-flashover situation (fully-engulfed fire). The field Models (CFD: Computer Fluid Dynamics) are excluded in this chapter. They are too complex and time consuming to be used as a simple tool.

6.1 Localised Fire

In a localised fire, there is an accumulation of combustion products in a layer beneath the ceiling (upper layer), with a horizontal interface between this hot layer and the lower layer where the temperature of the gases remains much colder.

This situation is well represented by a two zone model, useful for all pre-flashover conditions. Besides calculating the evolution of gas temperature, these models are used in order to know the smoke propagation in buildings and to estimate the life safety as a function of smoke layer height, toxic gases concentration, radiative flux and optical density.

The thermal action on horizontal elements located above the fire also depends on their distance from the fire. It can be assessed by specific models for the evaluation of the local effect on adjacent elements, such as Heskestad's or Hasemi's method [17].

6.1.1 Two zone models

Zone model is the name given to numerical programs which calculate the development of the temperature of the gases as a function of time, integrating the ordinary differential equations which

express the conservation of mass and the conservation of energy for each zone of the compartment. They are based on the fundamental hypothesis that the temperature is uniform in each zone. Zone models give not only the evolution of the temperature of the gases in the compartment, but also additional information such as the temperatures in the walls or the velocity of the gases through the openings.

The data which have to be provided to a zone model are:

- geometrical data, such as the dimensions of the compartment, the openings and the partitions;
- material properties of the walls;
- fire data, as RHR curve, pyrolysis rate, combustion heat of fuel.

In a two zone model the equations expressing the equilibrium of mass and of energy are written for each of the two layers and exchanges between the two layers are considered through air entrainment models.

As a result of the simulation, the gas temperature is given in each of the two layers, as well as information on wall temperatures and flux through the openings. An important result is the evolution, as a function of time, of the thickness of each layer. The thickness of the lower layer, which remains at rather cold temperature and contains no combustion products, is very important to assess the tenability of the compartment for the occupants. Figure 6.1 shows how a compartment is modelled by a two zone model, with different terms of the energy and mass balance represented.

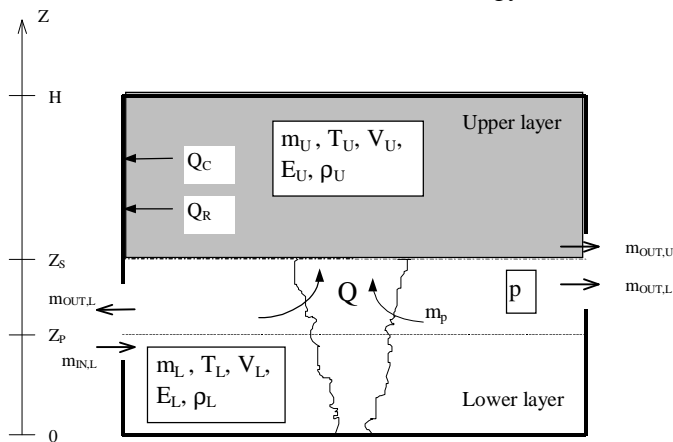

Figure 6.1 A compartment in a two zone model

Figure 6.1 is typical of a simple situation where the compartment exchanges mass and energy only with the outside environment. These kind of models have the capability to analyse more complex buildings where the compartment of origin exchanges mass and energy with the outside environment but also with other compartments in the building. This is of particular interest to analyse the propagation of smoke from the compartment of origin towards other adjacent compartments. Such a situation, analysed by multi-compartment two zone models, is depicted on Figure 6.2.

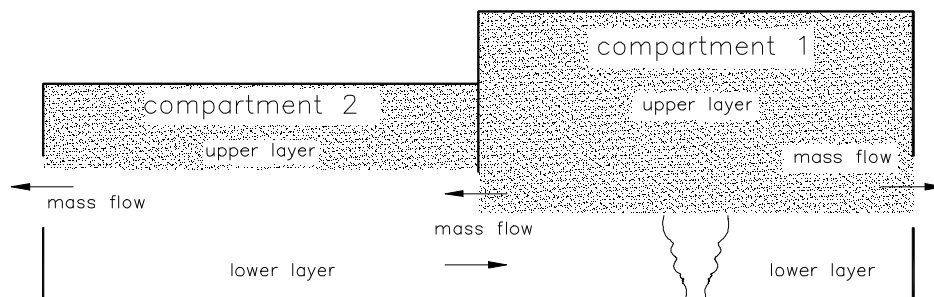

Figure 6.2 A compartment in a multi-compartment two zone model

6.1.2 The Heskestad method

The thermal action of a localised fire can be assessed by using the Heskestad method [1]. Differences have to be made regarding the relative height of the flame to the ceiling.

The flame lengths L_f of a localised fire (see Figure 6.3) is given by:

$$L_f = -1,02 D + 0,0148 Q^{2/5}$$

When the flame is not impacting the ceiling of a compartment ($L_f < H$; see Figure 6.3) or in case of fire

in open air, the temperature $\Theta_{(z)}$ in the plume along the symmetrical vertical flame axis is given by:

$$\Theta_{(z)} = 20 + 0,25 Q_c^{2/5} \cdot (z-z_0)^{-5/3}$$

where

D is the diameter of the fire [m], see Figure 6.3

Q is the rate of heat release [W] of the fire

Q_c is the convective part of the rate of heat release [W], with $Q_c = 0,8 Q$ by default

z is the height [m] along the flame axis, see Figure 6.3

H is the distance [m] between the fire source and the ceiling, see Figure 6.3

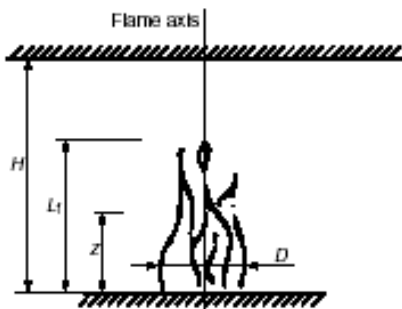

Figure 6.3 Localised fire model for flames not impacting the ceiling

6.1.3 Hasemi's method [1, 17]

Hasemi's method [1, 17] is a simple tool for the evaluation of the localised effect on horizontal elements located above the fire. It is based on the results of tests made at the Building Research Institute in Tsukuba, Japan.

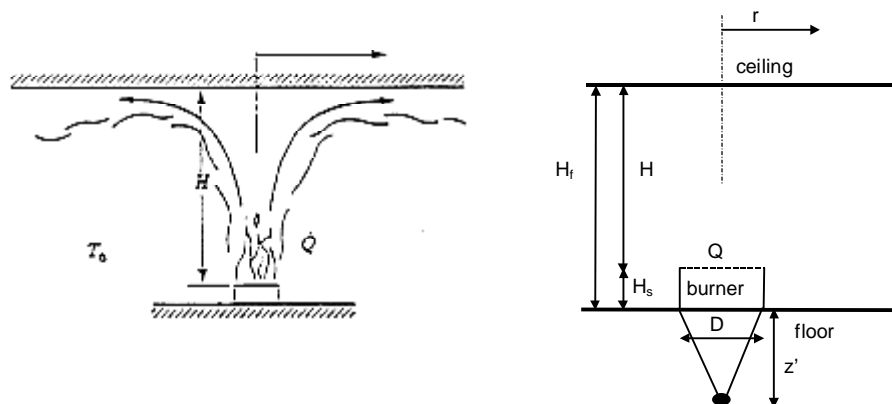

Figure 6.4 Localised fire scheme and Hasemi Fire description

The data for the application of the method are:

- Q Rate of the Heat Release of the fire [W]
- H_f height between floor and ceiling [m]
- D diameter (or characteristic length) of the fire [m]
- H_s vertical distance between the floor and the seat of the fire source [m]

The variables are:

- H distance between the fire source and the ceiling [m]
- Q^* non dimensional Rate of Heat Release [-]
- Q_H^* non dimensional Rate of Heat Release [-]
- z' vertical position of the virtual heat source, with respect to the seat of the fire source [m]
- L_H horizontal length of the flame on the ceiling [m]
- r horizontal distance, at the ceiling, from the centre of the fire [m]

The procedure is:

Calculate H
$$H = H_f - H_s \quad (6.1)$$

Calculate Q^*
$$Q^* = \frac{Q}{1,11 \times 10^6 D^{2,5}} \quad (6.2)$$

Calculate Q_H^*
$$Q_H^* = \frac{Q}{1,11 \times 10^6 H^{2,5}} \quad (6.3)$$

Calculate z'
$$z' = 2,4 D (Q^{*2/5} - Q^{*2/3}) \quad Q^* < 1,00 \quad (6.4)$$

$$z' = 2,4 D (1,00 - Q^{*2/5}) \quad Q^* \geq 1,00 \quad (6.5)$$

Calculate $(L_H + H)/H$
$$\frac{L_H + H}{H} = 2,90 Q_H^{*0,33} \quad (6.6)$$

Calculate L_H from the value calculated in the previous equation and from the value of H

Calculate the value of the flux q'' in $[kW/m^2]$ at a distance r, according to

$$q'' = 100 \quad y < 0,30 \quad (6.7)$$

$$q'' = 136,30 - 121,00 y \quad 0,30 < y < 1,0 \quad (6.8)$$

$$q'' = 15 y^{-3,7} \quad y > 1,0 \quad (6.9)$$

where
$$y = \frac{r + H + z'}{L_H + H + z'} \quad (6.10)$$

The flux q'' received by the ceiling decreases as a function of the ratio y and increases as a function of Q. In the Figure 6.5 these functions are shown for the case:

r = 0 H = 5 m D = 3 m

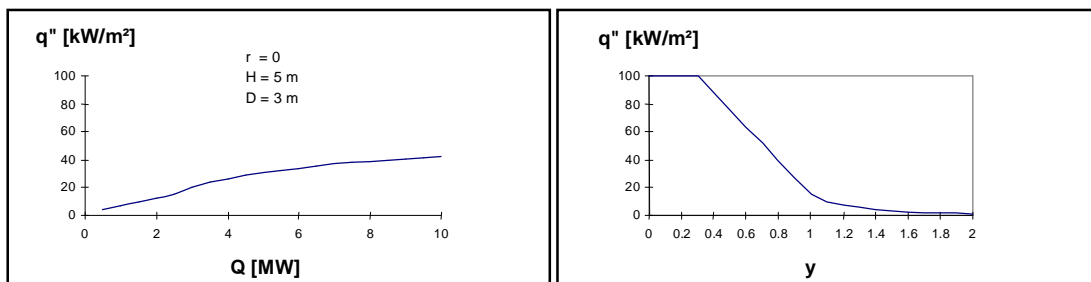

Figure 6.5 q'' as a function of y and Q

6.1.4 Combination of 2 zone model and localised fire model

In a localised fire the gas temperature distribution in the compartment may be estimated by a 2 zone model. In this model the gas temperature in each layer is calculated with the hypothesis that it is uniform in each layer. This average temperature in the hot zone is generally sufficiently accurate as far as global phenomena are considered: quantity of smoke to be extracted from the compartment, likelihood of flashover, total collapse of the roof or ceiling, etc.

When it comes to estimating the local behaviour of a structural element located just above the fire, the hypothesis of a uniform temperature may be unsafe and the two zone model has to be combined with the localised fire formula given at the 6.1.3 paragraph.

The temperatures close to the beam are obtained by – for each point alongside the beam – taking the highest temperature predicted by each of the models.

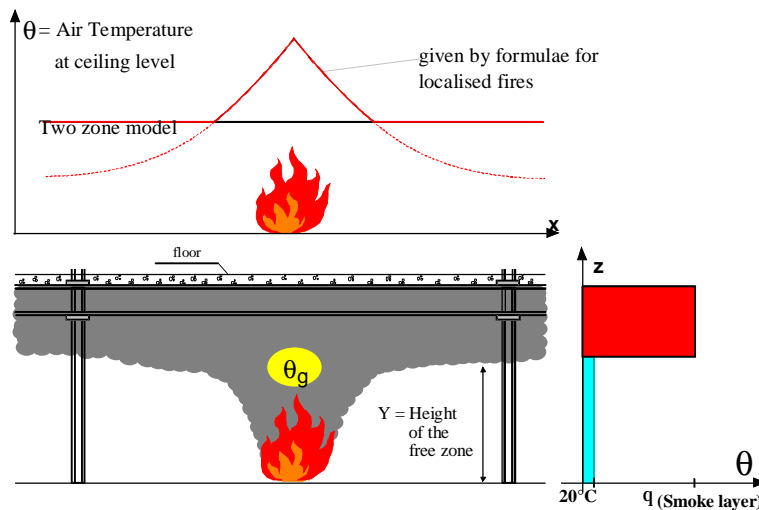

Figure 6.6 Combination of two-zone- with localised fire model

The height of the smoke zone and the temperatures of the hot gases at the level of the steel structures at different distances from the fire can be calculated by the model TEFINAF [8]. This model combines a two zone model which provides the height and the mean temperature of the hot zone and the localised fire formula which gives the temperature peak just above the fire and at different distances from the fire.

6.2 FULLY ENGULFED FIRE

To model a fully engulfed fire within a building there are several types of models. Some of the most widely used are described in this chapter.

The natural fire concept is an alternative to the nominal fires defined in prescriptive codes (ISO, hydrocarbon curves...).

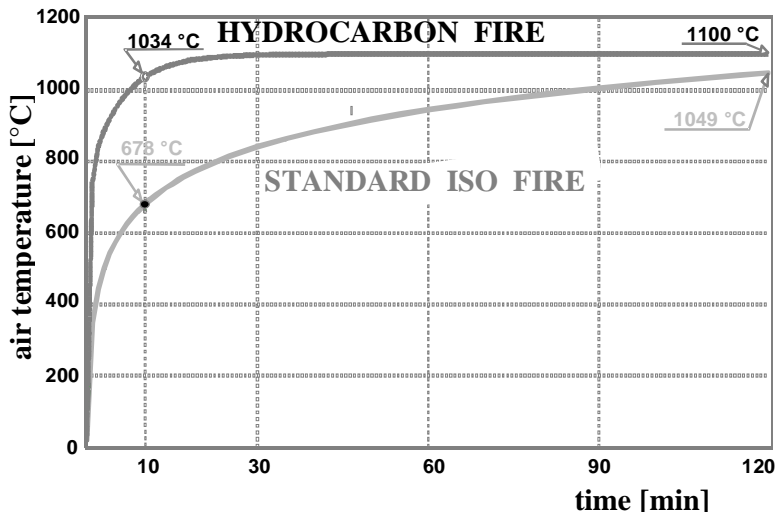

Figure 6.7 Standard- and Hydrocarbon fire curves

The field models (CFD) are not included in this chapter. They are too complex and need too much time and data in order to use them as a simple engineering tool.

6.2.1 Parametric fires

Parametric fires provide a simple means to take into account the most important physical phenomenon, which may influence the development of a fire in a particular building. Like nominal fires, they consist of time temperature relationships, but these relationships contain some parameters deemed to represent particular aspects of reality.

In almost every parametric fire which can be found in the literature, the parameters taken into account, in one way or another, are:

- the geometry of the compartment
- the fire load within the compartment,
- the openings within the walls and/or in the roof and
- the type and nature of the different construction elements forming the boundaries of the compartment.

Parametric fires are based on the hypothesis that the temperature is uniform in the compartment, which limits their field of application to post-flashover fires in compartments of moderate dimensions. They nevertheless constitute a significant step forward toward the consideration of the real nature of a particular fire when compared to nominal fires, while still having the simplicity of some analytical expressions, i.e. no sophisticated computer tool is required for their application.

A proposal is made in the informative annex A of EN 1991-1-2 [1] for such a parametric fire. It is valid for compartments up to 500 m² of floor area, without openings in the roof and for a maximum compartment height of 4 m. b must be in the range 1.000 to 2.200 J/m²s^{1/2}K, and O must be comprised between 0,02 and 0,20. (O and b are defined here below).

Some corrections have been made to improve the proposal of the ENV1991-2-2 [23]. They are:

- a more correct way to calculate the thermal effusivity (b factor) in walls made of layers of different materials;
- the introduction of a minimum duration of the fire, taking into account a fuel controlled fire when the fire load is low and the openings are large;
- a correction factor which takes into account the large mass flow through opening in case of fuel controlled fires.

This new formulation of the parametric fire is now presented and is valid for any b .

The evolution of the gas temperature within the compartment is given by :

$$q_g = 1,325 \left(1 - 0,324e^{-0,2\dot{t}} - 0,204e^{-1,7\dot{t}} - 0,472e^{-19\dot{t}} \right) + 20^\circ \text{C} \quad (6.11)$$

with

$$\dot{t} = \Gamma t \quad (6.12)$$

$$\Gamma = \frac{(O/0,04)^2}{(b/1160)^2} \quad (6.13)$$

$$O = A_v \sqrt{h} / A_t \quad (6.14)$$

and

t time, in hour,

A_v area of vertical openings, in m^2 ,

h height of vertical openings, in m,

A_t total area of enclosure (walls, ceiling and floor, including openings), in m^2 ,

b is the so-called b-factor in $[\text{J}/\text{m}^2\text{s}^{1/2}\text{K}]$. It is function of the thermal inertia of boundaries (see § 3.3 for b calculation).

The duration of the heating phase is determined by:

$$t_{\max} = \max(0,2 \times 10^{-3} q_{t,d} / O ; t_{\lim}) \quad [\text{hour}] \quad (6.15)$$

with:

$q_{t,d}$ design value of the fire load density related to A_t , in MJ/m^2 ,

t_{\lim} 20 minutes, similar to the free burning fire duration τ_F assumed in Annex B of EN 1991-1-2 [1].

When applying equation 6.15, two different possibilities exist:

- Either the duration of the heating phase of the fire calculated from the first term of the equation, $0,2 \times 10^{-3} q_{t,d} / O$, is larger than the chosen limit time t_{\lim} , in which case equations 6.11 to 6.14 and equations 6.21 to 6.23 are applied as such, without any modification.
- Or the duration of the heating phase of the fire calculated from the first term of the equation, $0,2 \times 10^{-3} q_{t,d} / O$, is shorter than the chosen limit time t_{\lim} . In this case, equations 6.11 to 6.14 are applied with a modified opening factor, O_{\lim} , calculated as the one leading to the chosen limit time from the following equation:

$$O_{\lim} = 0,1 \times 10^{-3} q_{t,d} / t_{\lim} \quad (6.16)$$

Equation 6.15 and 6.16 are modified in the following way:

$$\dot{t}_{\lim} = \Gamma_{\lim} t \quad (6.17)$$

$$\Gamma_{\lim} = \frac{(O_{\lim}/0,04)^2}{(b/1160)^2} \quad (6.18)$$

and t_{\lim}^* is used in equation 6.11 instead of t^* .

Last, in order to take the effect of the ventilation during the heating phase, in the case of $t_d = t_{\lim}$:

If $O > 0,04$ and $q_{t,d} < 75$ and $b < 1160$

$$\text{then } k = 1 + \left(\frac{O - 0,04}{0,04} \right) \left(\frac{q_{t,d} - 75}{75} \right) \left(\frac{1160 - b}{1160} \right) \quad (6.19)$$

$$\text{and } \Gamma_{\lim} = k \frac{(O_{\lim}/0,04)^2}{(b/1160)^2} \quad (6.20)$$

The temperature-time curve during the cooling phase is given by:

$$q_g = q_{\max} - 625(t - t_{\max}^* . x) \quad \text{for } \dot{t}_d \leq 0,5 \quad (6.21)$$

$$q_g = q_{\max} - 250(3 - t_{\max}^*)(t - t_{\max}^* . x) \quad \text{for } 0,5 \leq \dot{t}_d \leq 2,0 \quad (6.22)$$

$$q_g = q_{\max} - 250(t - t_{\max}^* . x) \quad \text{for } 2,0 \leq \dot{t}_d \quad (6.23)$$

with q_{max} maximum temperature at the end of the heating phase given by 6.11 where $t = t_d$ given by 6.15.

$$t_{max}^* = (0,2 \times 10^{-3} q_{t,d} / O) \cdot \Gamma$$

$$x = I \quad \text{for} \quad t_{max} > t_{lim}$$

$$x = \frac{t_{lim} \cdot \Gamma}{t_{max}^*} \quad \text{for} \quad t_{max} = t_{lim}$$

An example of results (fire load $q_{t,d} = 180 \text{ MJ/m}^2$, $b = 1.160 \text{ J/m}^2 \text{ s}^{1/2} \text{ K}$, opening factor O from $0,04 \text{ m}^{1/2}$ to $0,20 \text{ m}^{1/2}$) is shown on Figure 6.8.

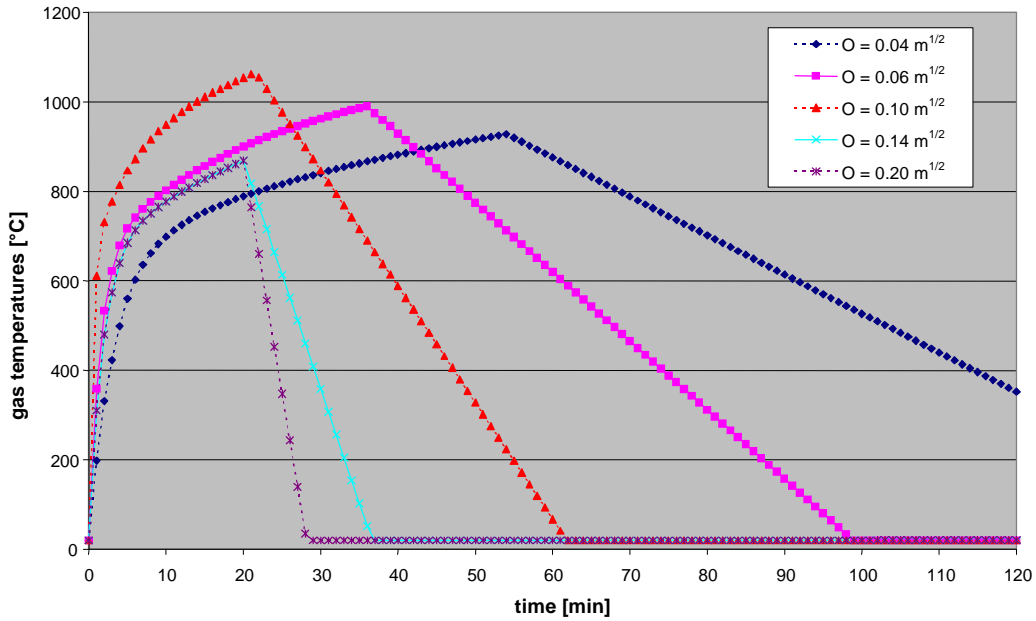

Figure 6.8 Example of parametric fires [1]

With the parametric fire, the comparison has been made between the results of tests [12] and the results of the improved predictions. Figure 6.9 concerns the maximum temperature in the gas. The coefficient of correlation, which had the value of 0,19 with the formulas of the ENV 1991-2-2 [23], has now a value of 0,83.

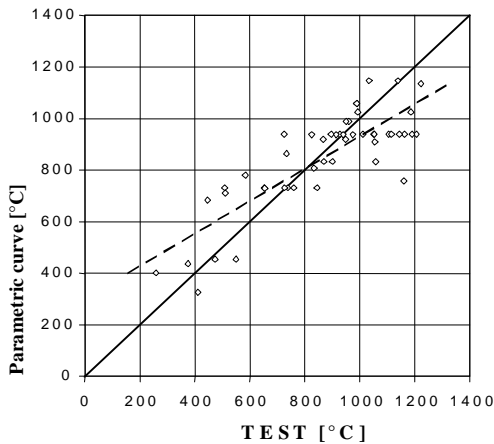

Figure 6.9 Maximum gas temperature in the compartment

6.2.2 Zone models

Zone models have been already introduced in the chapter 6.1.1, where a short description of a two-zone model was presented. The application field of a two zone model is the pre-flashover phase of the fire. For a fully engulfed fire a one-zone model should be used.

6.2.3 One zone model

The one zone model is based on the fundamental hypothesis that, during the fire, the gas temperature is uniform in the compartment. One-zone models are valid for post-flashover conditions.

The data have to be supplied with a higher degree of detail than for the parametric curves and are the same, as those required for a two-zone model.

Figure 6.10 shows how a compartment fire is modelled, with different terms of the energy and mass balance represented.

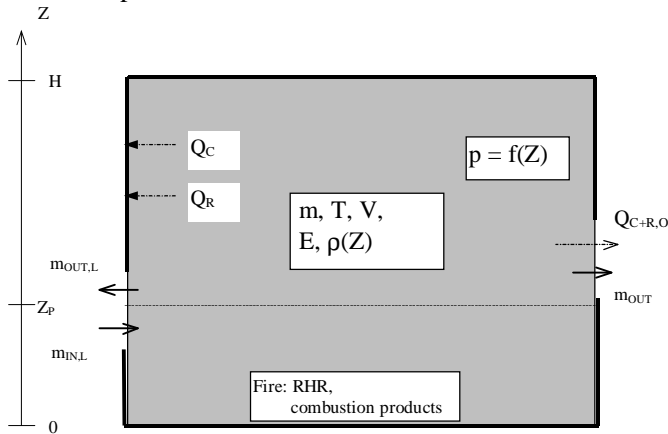

Figure 6.10 A compartment in a one zone model

In the scope of the ECSC projects NFSC 1 & 2 [11, 12] the two-zone model OZone, has been developed at University of Liège together with PROFILARBED-Research and has been validated, taking as reference the results of 54 experimental tests. Figures 6.11 gives a comparison of the maximum gas temperature as measured in the test and computed by the model. Each point is representative of a test and the oblique line is the location of the points giving a perfect fit. The dotted line is the linear regression among all points.

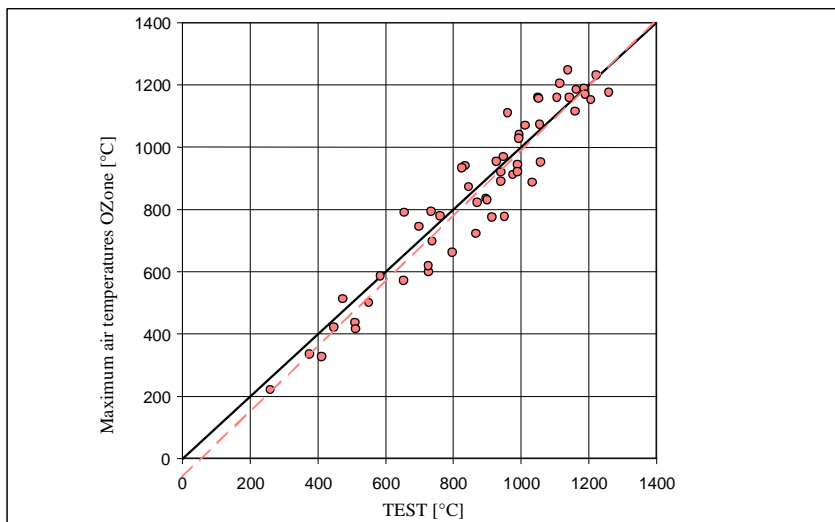

Figure 6.11 Maximum gas temperature in the compartment

Another comparison is represented in Figure 6.12. For each test, the temperature evolution was computed in a typical unprotected steel section - HEB 200, $A_m/V = 147 \text{ m}^{-1}$ - first submitted to the recorded gas temperature, then submitted to the computed gas temperature. This allowed to draw the graph where each test is represented by the maximum temperature in the unprotected steel section.

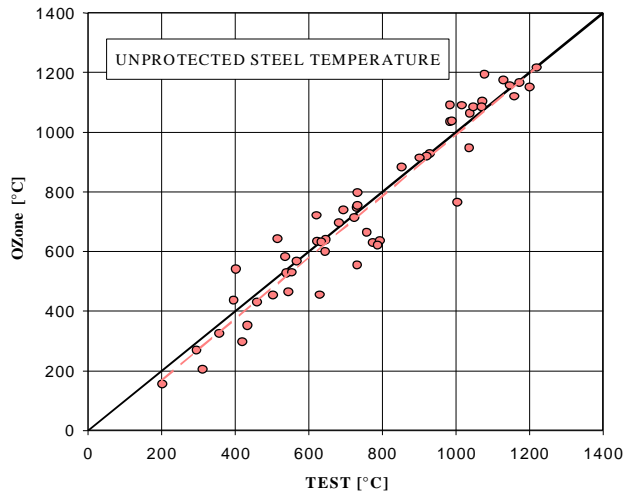

Figure 6.12 Maximum temperature in the unprotected steel section

6.3 Combination of 1-zone and 2-zones models. Choice of the model

After having defined the fire characteristics, i.e. RHR curve, compartment geometry, wall characteristics, it is necessary to choose the natural fire model to apply according to the considered scenario. This choice will be made in accordance with the application domain of the models.

In this consideration, it is assumed that the first application has to be a “two zone model” application. The question is how and when the transition from the “two zone model” application to a “one zone model” application occurs.

The results of a “two zone model” are given in the form of two main variables:

- temperature of the upper zone T_u ;
- height of the interface of the two zones H_i

These two variables will condition the simulation with the zone model (see figure 6.15). The four following conditions are able to limit the application of a “two zone model”:

- condition 1 (C1): $T_u > 500^\circ\text{C}$
the high temperature of combustion products (higher than 500°C) leads to a flashover by radiative flux to the other fire loads of the compartment;
- condition 2 (C2): $H_i < H_q$ and $T_u > T_{\text{ignition}}$
the decrease of the interface height (H_i) is such that the combustible material is in the smoke layer (maximum height with combustible H_q), and if the smoke layer has a high temperature (higher than T_{ignition} which is assumed be 300°C), leads to propagation of fire in all compartment by combustible ignition;
- condition 3 (C3): $H_i < 0,1 H$
the interface height goes down and leads to a very small lower layer thickness, which is not representative of two zone phenomenon;
- condition 4 (C4): $A_{fi} > 0,5 A_f$
the fire area is too high compared to the floor surface of the compartment to consider a localised fire.

In fact, the conditions 1 or 2 lead to a modification of the initial rate of heat release (simulation with two-zone model), for a one-zone model simulation. This modification is made as indicated in Figure 6.13.

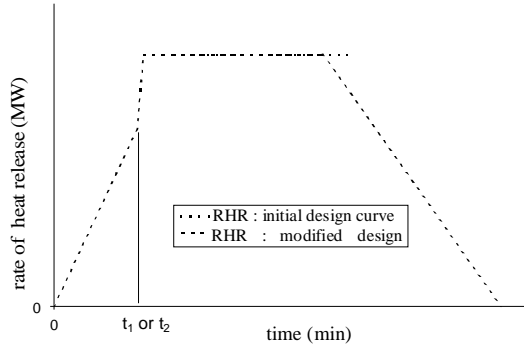

Figure 6.13 Design curves for rate of heat release of the fire

The above approach presented in the scheme of Fig. 6.14. In this scheme it is shown under which conditions (two- or one-zone modelling) the design temperature curves have to be determined.

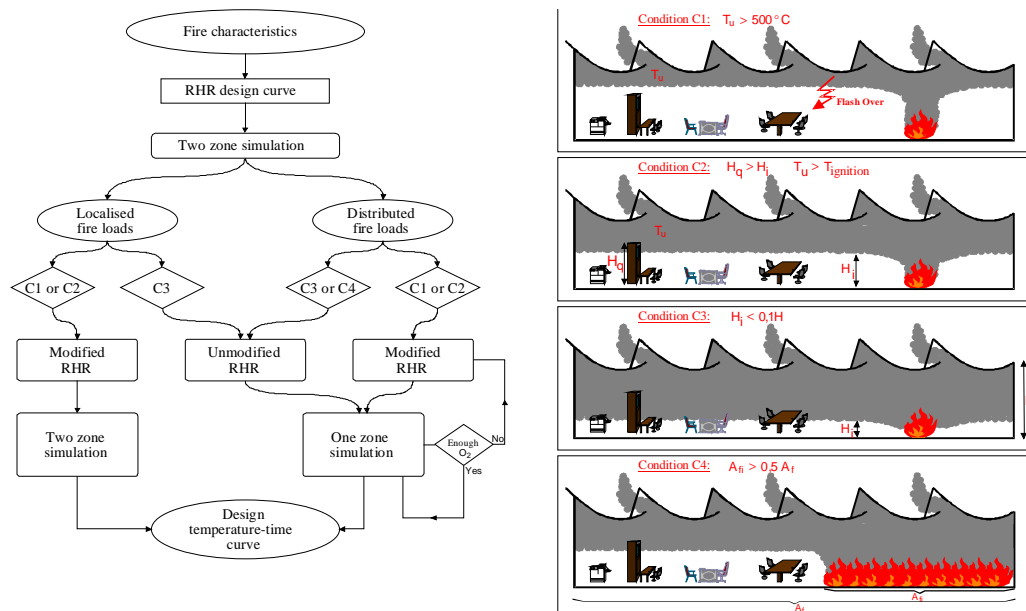

Figure 6.14 Combination of 1 and 2 zone model

7 MECHANICAL ACTIONS ACCORDING TO EUROCODES

Under fire situation, the applied loads to structures can be obtained according to following formula (see relation 6.11b of EN1990):

$$\sum_{i \geq 1} G_{k,i} + (\Psi_{1,1} \text{ or } \Psi_{2,1}) Q_{k,1} + \sum_{i \geq 2} \Psi_{2,i} Q_{k,i}$$

where:

$G_{k,i}$: characteristic values of permanent actions

$Q_{k,1}$: characteristic leading variable action

$Q_{k,i}$: characteristic values of accompanying variable actions

$\Psi_{1,1}$: factor for frequent value of a variable action

$\Psi_{2,i}$: factor for quasi-permanent values of variable actions

The recommended values of ψ_1 and ψ_2 are given in table A1.1 of EN1990 but could be modified in National Annex.

Table 7.1 - Recommended values of γ factors for buildings

Action	Ψ_0	Ψ_1	Ψ_2
Imposed loads in buildings, category (see EN 1991-1.1)			
Category A : domestic, residential areas	0,7	0,5	0,3
Category B : office areas	0,7	0,5	0,3
Category C : congregation areas	0,7	0,7	0,6
Category D : shopping areas	0,7	0,7	0,6
Category E : storage areas	1,0	0,9	0,8
Category F : traffic area vehicle weight $\leq 30\text{kN}$	0,7	0,7	0,6
Category G : traffic area, $30\text{ kN} < \text{vehicle weight} \leq 160\text{kN}$	0,7	0,5	0,3
Category H : roofs	0	0	0
Snow loads on buildings (see EN1991-1.3)			
Finland, Iceland, Norway, Sweden	0,70	0,50	0,20
Remainder of CEN Member States, for sites located at altitude $H > 1000\text{ m a.s.l.}$	0,70	0,50	0,20
Remainder of CEN Member States, for sites located at altitude $H \leq 1000\text{ m a.s.l.}$	0,50	0,20	0
Wind loads on buildings (see EN1991-1.4)	0,6	0,2	0
Temperature (non-fire) in buildings (see EN1991-1.5)	0,6	0,5	0

Another important notation largely used in fire design methods of Eurocodes is the load level for the fire situation $\eta_{fi,t}$ which is defined as $h_{fi,t} = \frac{E_{d,fi}}{E_d}$ with E_d and $E_{d,fi}$ respectively design effect of actions at room temperature design and design effect of actions for the fire situation. It can be alternatively determined by:

$$h_{fi,t} = \frac{G_k + \gamma_{fi,1} Q_{k,1}}{g_G G_k + g_{Q,1} Q_{k,1}}$$

where $g_{Q,1}$ is the partial factor for leading variable action 1.

In fact, the load level h_{fi} depends strongly on the factor $\gamma_{1,1}$ which varies as function of building categories. In EN 1993-1-2 (fire part for steel structures) and EN 1994-1-2 (fire part for composite structures), following figure (figure 4) is provided to show clearly the influence of both load ratio $Q_{k,1}/G_k$ and the factor $\gamma_{1,1}$ on load level.

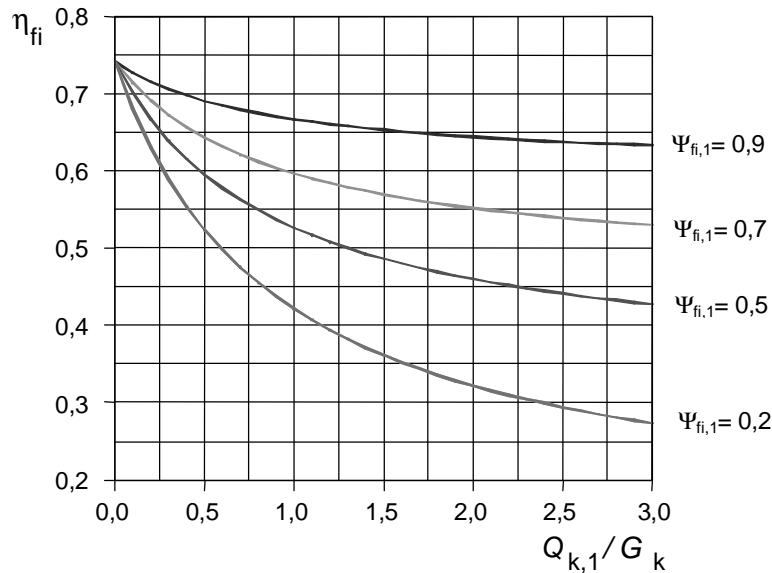

Figure 7.1 - Variation of the reduction factor h_{fi} with the load ratio $Q_{k,1}/G_k$

8 CONCLUSION

In this WP we have seen the various models available to calculate the temperature inside a compartment as a function of time as well as the needed data. To know the temperature of the structural elements as a function of time, it is necessary to calculate the heat flux to these elements. Convective and radiative heat transfer occur between the hot gases, the flame, the surrounding boundary constructions and the structural element. Emissivities and convection coefficients govern the heat transfer.

The heating up of a structural element depends on the type of element (e.g. pure steel or composite-steel/concrete) and of the nature and amount of fire protection. This is the subject of the WP2.

Knowing the temperature field in the structure and the accidental combination of loads, its thermo-mechanical behaviour can be determined. It is the subject of WP3.

9 REFERENCES

- [1] CEN; EN 1991-1-2, Eurocode 1- Actions on structures, Part 1.2-Actions on structures exposed to fire. CEN Central Secretariat, Brussels, November 2002.
- [2] BSI 96/540493 "The use of Fire Safety Engineering in Buildings" (Draft 27 march 1996)
- [3] Initial Fires: Lund University, Sweden. Institute of Fire Safety Engineering. ISSN 1102-8246. ISRN LUTVDG/TVBB--3070--SE. April 1993.
- [4] ARGOS Theory Manuel (draft 5)-Danish Institute of fire technology - 22/07/92
- [5] Peacock, Jones, Bukowski and Forney. NIST Handbook 146, Volume II - Technical Reference Guide for the Hazard I Fire Hazard Assessment Method - Version 1 - June 1991
- [6] Babrauskas Vytenis: "Burning Rates" Section 3/Chapter 1: The SFPE Handbook of Fire Protection Engineering - Second Edition - 13th April 1995
- [7] NKB Committee and Works reports 1994:07E: "Performance and Requirements for Fire Safety and Technical Guide for Verification by Calculation"; Nordic Committee on Building Regulations.
- [8] "Development of design rules for steel structures subjected to natural fires in Large Compartments"; Final report CEC Agreement 7210/ SA210, 317,517,618,832-February 1997.
- [9] Schleich J-B., Cajot L-G., et al.: "Development of design rules for steel structures subjected to natural fires in Closed Car Parks" ECSC Research 7210-SA/211/318/518/620/933; 1993-1996; Final report 1999 – EUR 18867 EN
- [10] CEN; EN1990, Eurocode – Basis of structural design, 2003.

- [11] Schleich J-B., Cajot L-G., et al.: "Competitive steel buildings through natural fire safety concept." ECSC Research 7210-SA/125,126,213,214,323,423,522,623,839,937, 1994-98; Final Report 2002 – EUR 20360 EN.
- [12] Schleich J-B., Cajot L-G., et al.: "Natural fire safety concept –Full scale tests, implementation in the Eurocodes and development of a user-friendly design tool." ECSC Research 7210-060, 1997-2000; Final Report 2003 - EUR 20580 EN.
- [13] Schleich J-B., Cajot L-G., et al.: "Valorisation project - Natural Fire Safety Concept." ECSC Research 7215-PA/PB/PC –042-057, D-E-F-I-NL-UK & ECCS, 1999-2001.
- [14] DD 0000 The Use of Fire Safety Engineering in Buildings. Draft for Approval for Publication; 27. March 96, Technical Committee FSH / 24. 96/540493.
- [15] Fontana M.: "Required Fire Resistance of Building Elements" - Part A: Fire Load in Buildings, Probability Density Function - , NFSC WG4, Zürich, March 1996
- [16] Background document Eurocode 1 (ENV 1991) Part 1 : Basis of Design, Working Document N° 94 of ECCS, March 1996.
- [17] Hasemi Y. and Tokunaga Tazo: "Flame Geometry Effects on the Buoyant Plumes from Turbulent Diffusion Flames". Fire Science and Technology, Vol.4, N°1, 1984.
Ptchelintsev A., Hasemi Y., Nikolaenko M., "Numerical Analysis of Structures exposed to localized Fire", ASIAFLAM's 95, Hong Kong, 1995.
Wakamatsu T., Hasemi Y., Yokobayashi Y., Ptchelintsev A.: "Experimental Study on the Heating Mechanism of a Steel Beam under Ceiling exposed to a localized Fire".
Hasemi Y., Yokobayashi Y. , Wakamatsu T., Ptchelintsev A.: "Fire Safety of Building Components Exposed to a Localized Fire"- Scope and Experiments on Ceiling/Beam System Exposed to a Localized Fire, ASIAFLAM's 95, Hong Kong, 1995.
- [18] Hietaniemi J: " Risk-Based Fire Resistance Requirements" ECSC Research 7210-PR-251, 2000-2003
- [19] Kumar S., Welch S., "Natural Fire Safety Concept – The development of a CFD-Based Engineering methodology for evaluating thermal action on steel and composite structures" 7210-PR184, 1999-2002
- [20] iABSE Colloquium: Basis of Design and Actions on Structures; Background and applications of EC 1; delft 1996
- [21] Evaluation du Risque d'Incendie", Méthode de Calcul, Société Suisse des Ingénieurs et des Architectes, documentation n° 81, 1984.
- [22] Thomas P.H.: "Design Guide Structural Fire Safety", Workshop CIB W14, February 1995.
- [23] CEN; ENV1991-2-2, Eurocode 1– Basis of s design and actions on structures- Part 2-2: Actions on structures- Actions on structures exposed to fire, 1995.
- [24] Cajot L-G, Haller M., et al: "Probabilistic Quantification of a Steel Structure highlighting the potential of steel versus other materials" ECSC Research 7210-PA/PB/PC/PD-249, 2000-2003

QUALITY RECORD		WP1		
Title	Thermal & Mechanical Actions			
Eurocode reference(s)	EN 1990;2004; EN 1991-1-2:2005			
ORIGINAL DOCUMENT				
	Name	Company	Date	
Created by	O. Vassart	ArcelorMittal	24/11/2005	
	L.G Cajot	ArcelorMittal	24/11/2005	
	M. Brasseur	ArcelorMittal	24/11/2005	
Technical content checked by	M. Haller	ArcelorMittal	24/11/2005	
TRANSLATED DOCUMENT				
Translation made and checked by:	Z. Sokol	CTU in Prague	10/01/2008	
Translated resource approved by:	F. Wald	CTU in Prague	25/01/2008	
National technical contact:	F. Wald	CTU in Prague		