

The problem of robustness in fire

Ian Burgess



Robustness ... a working definition

“The ability of a structure to avoid disproportionate collapse when subject to a localised failure”

Hence: Only structural resistance failure is considered



Why is it important in fire ?



Multiple localised structural failures in fire + impact damage.



Collapse of the whole structure, including 90% unaffected by fire or impact.

Key NIST Post-WTC Recommendation

Increase structural integrity

“Develop design tools and modify codes to prevent progressive collapse.”

3



Steel behaviour at high temperatures

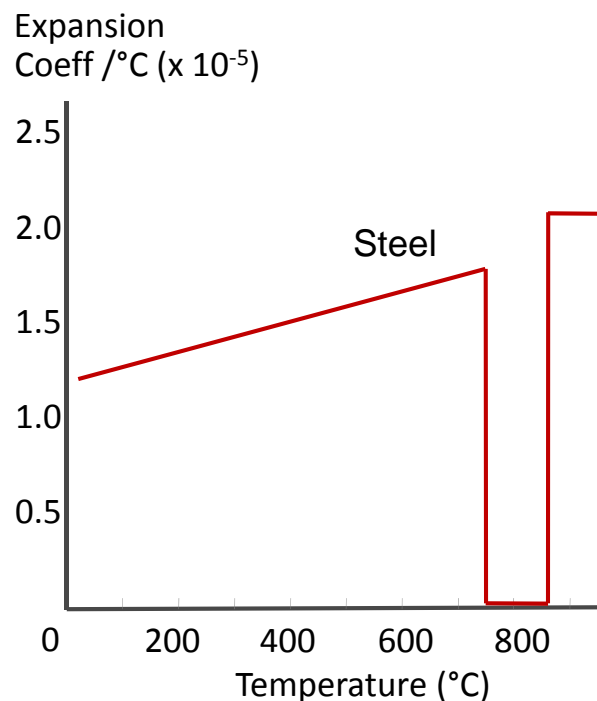
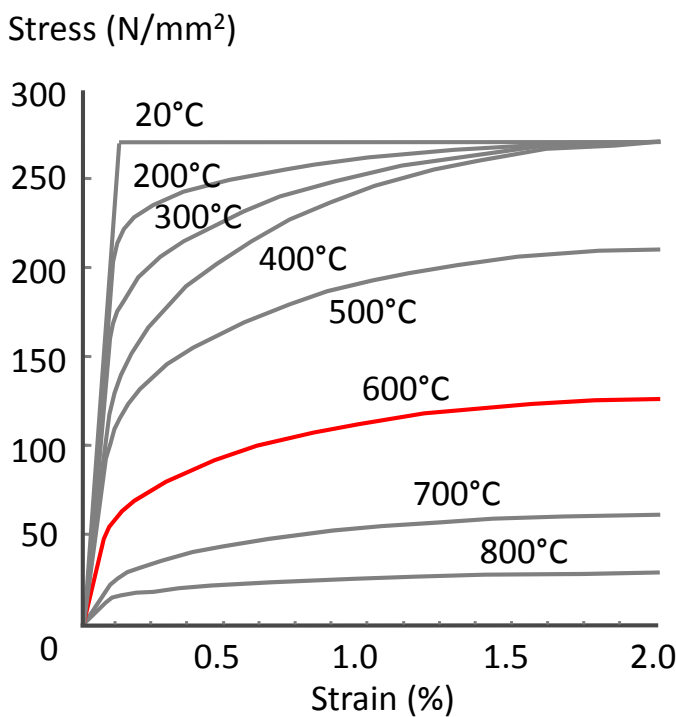



Sources of disproportionate collapse



Multi-storey construction: composite buildings

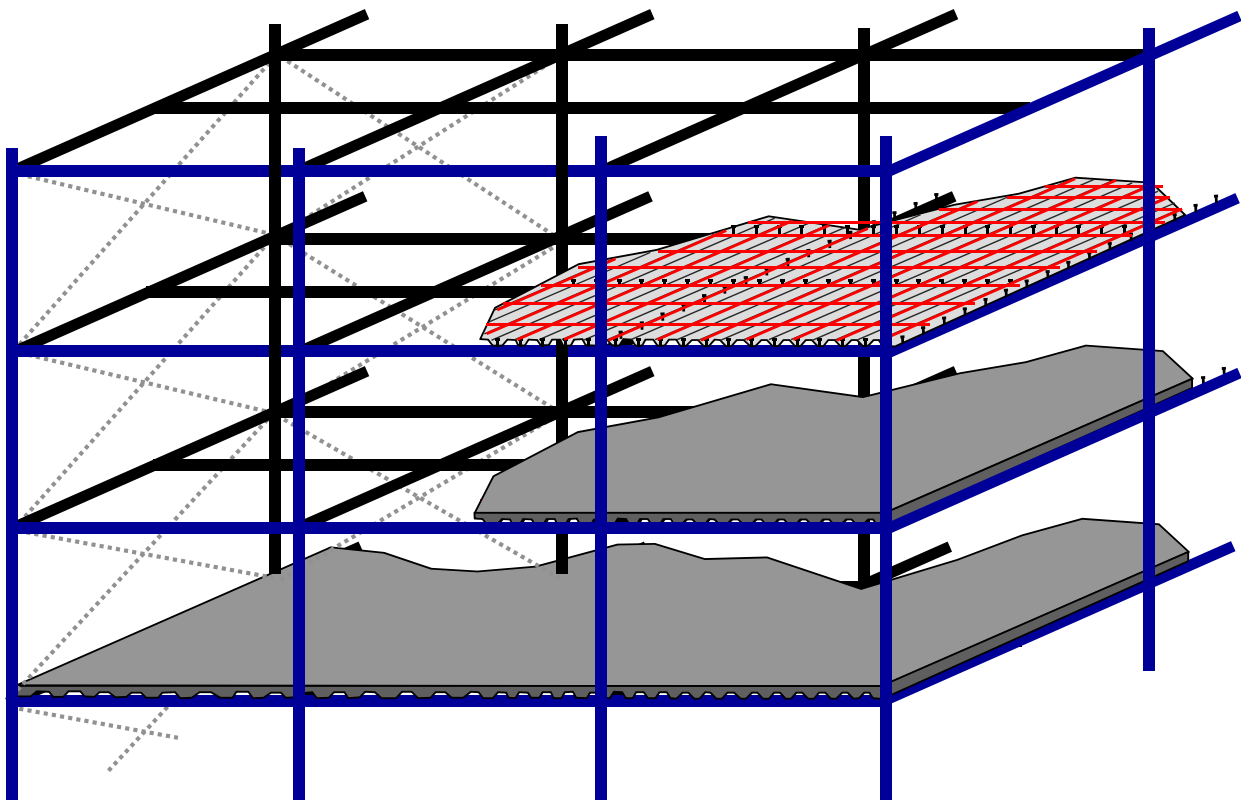



Multi-storey construction: composite buildings

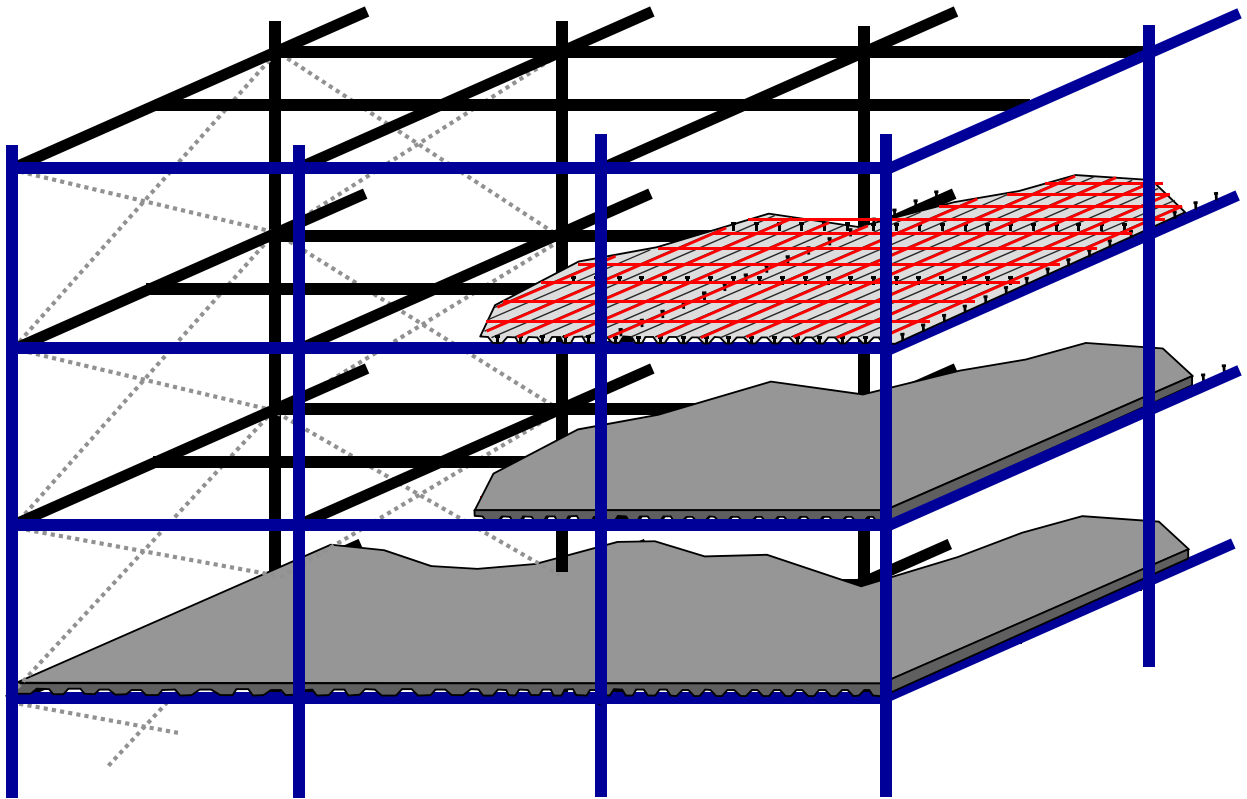

7



Multi-storey construction: composite buildings

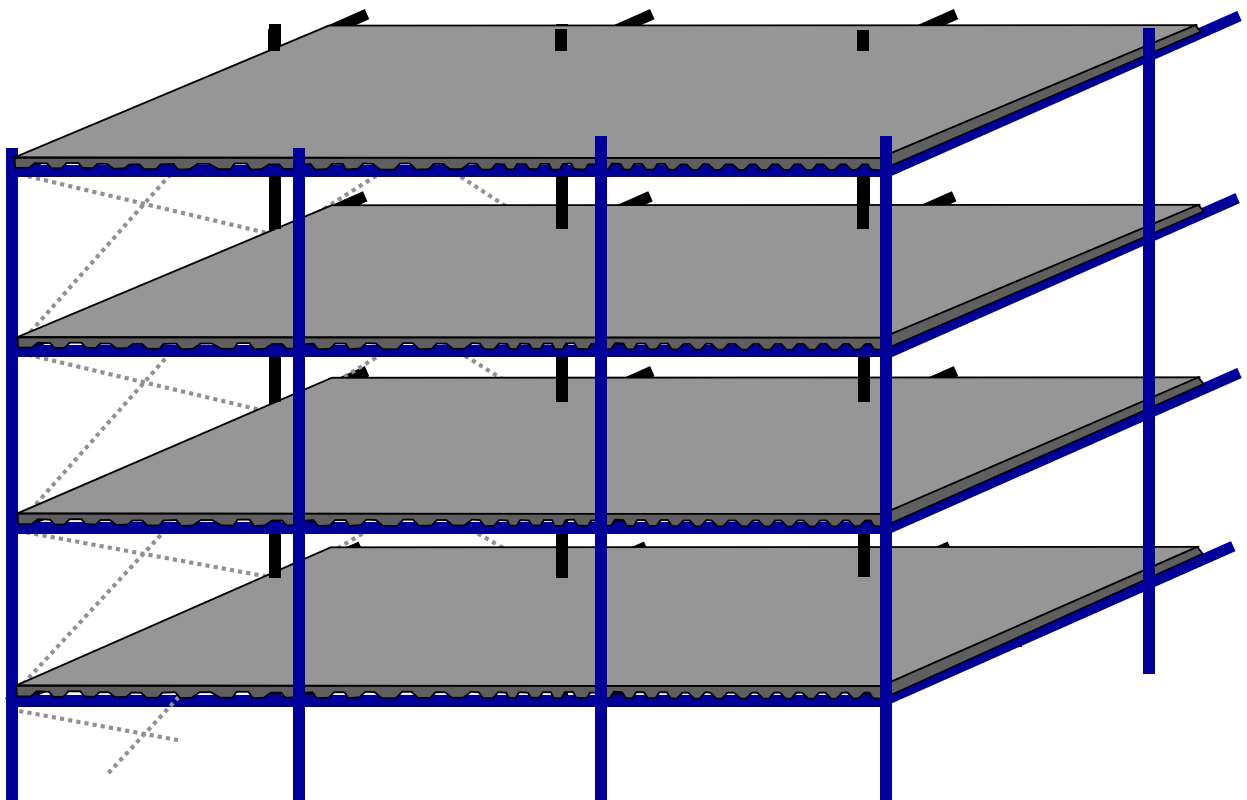

8



Whole-storey fire

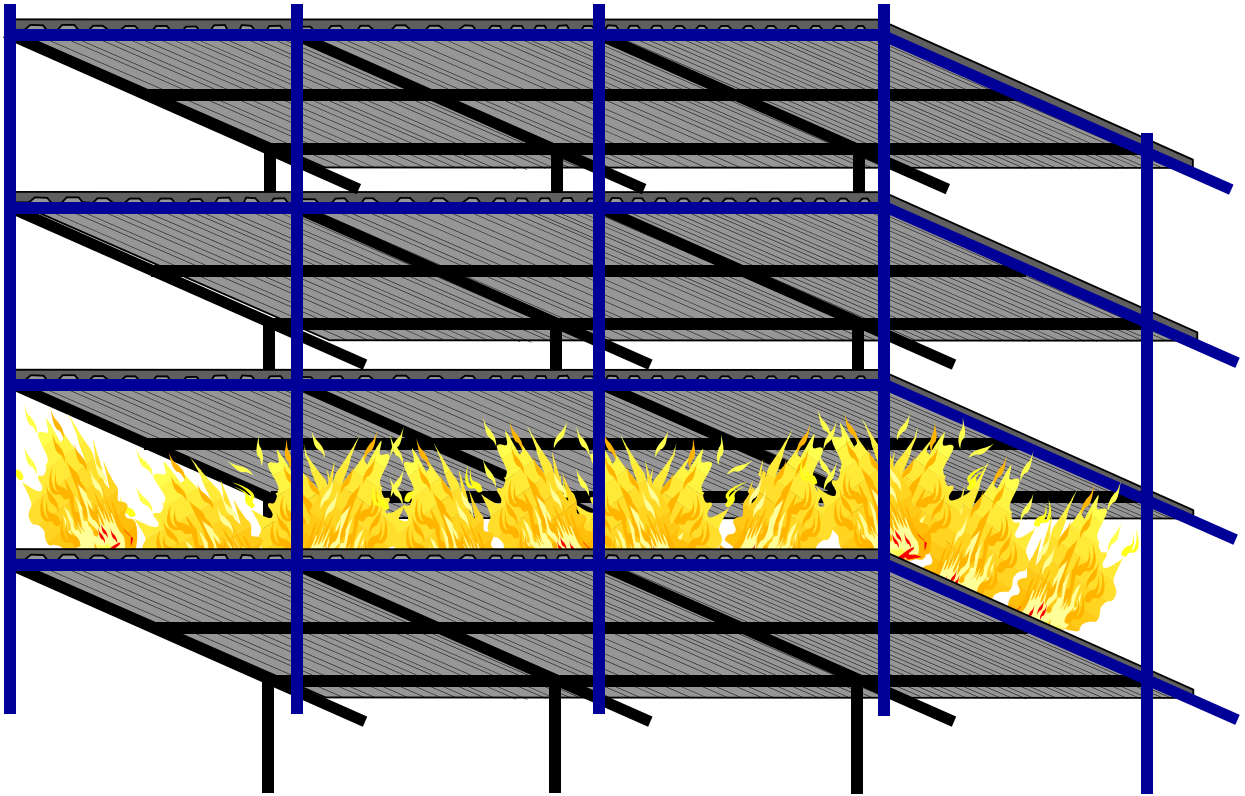

Whole-storey fire

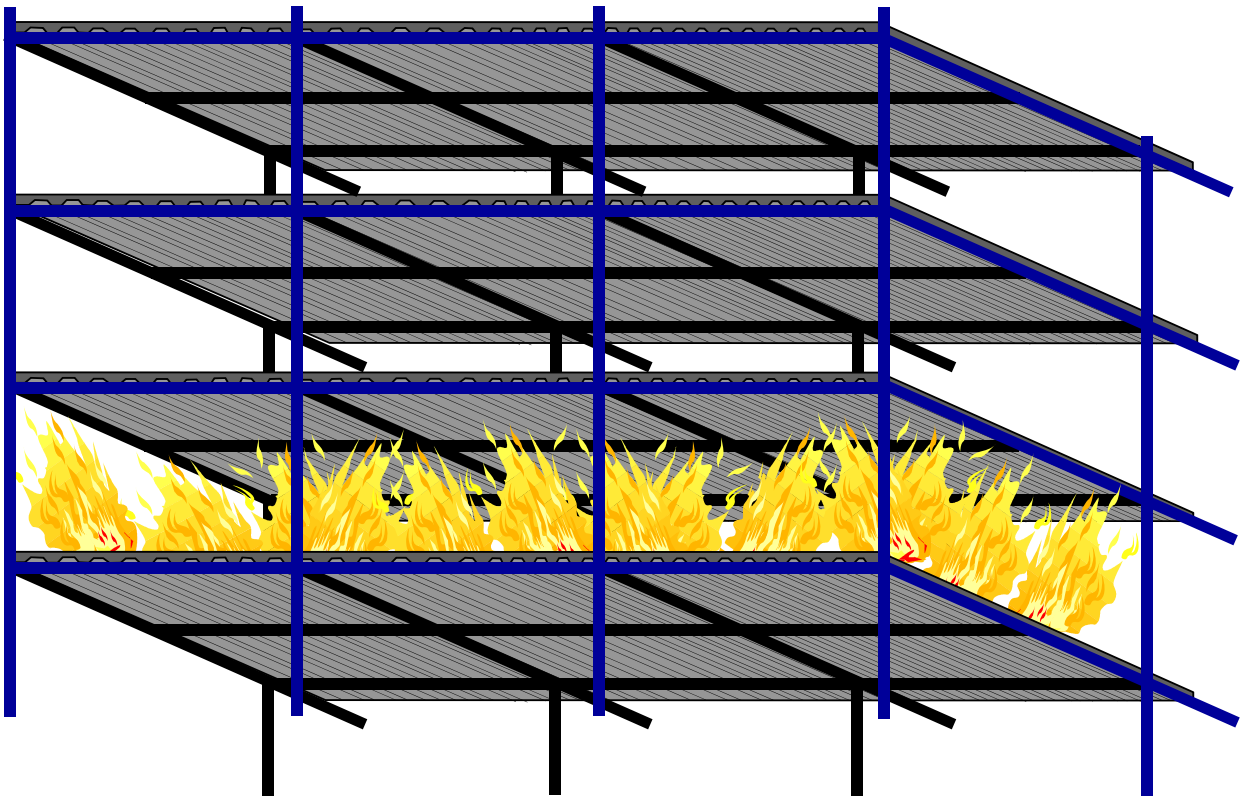



Local failures

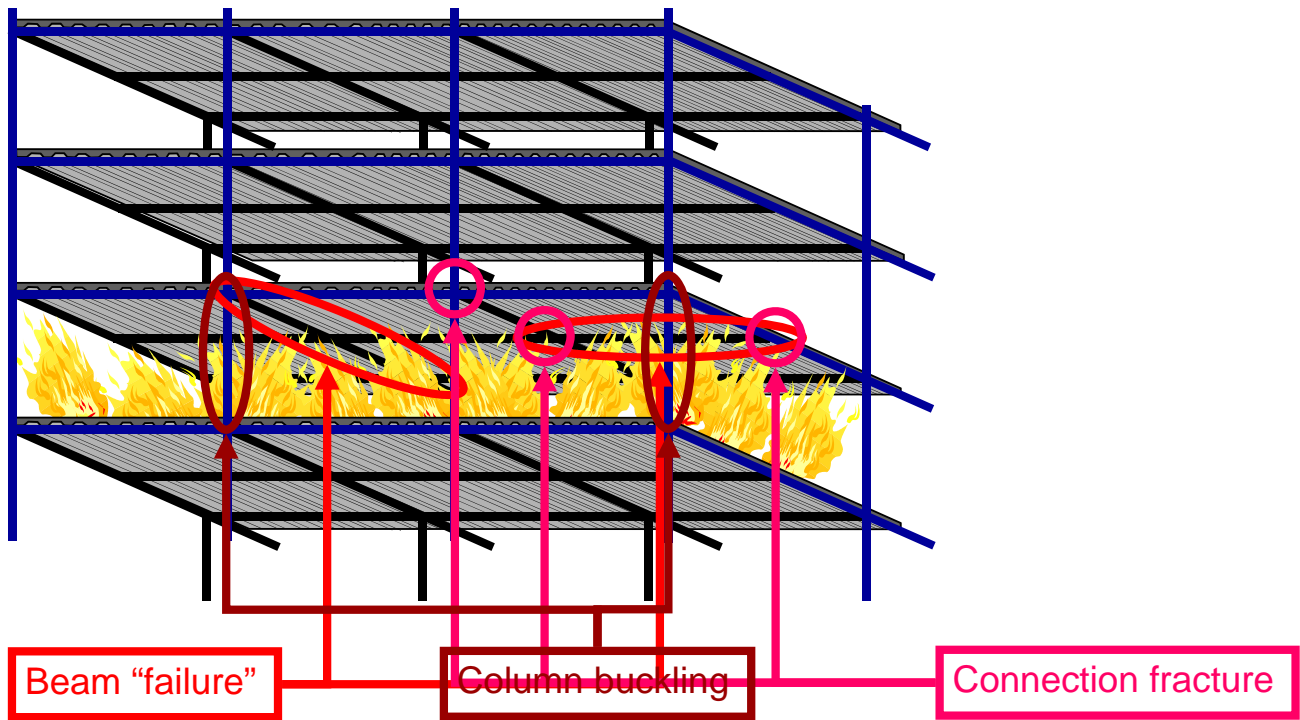

Beam "failure"



Consequence of excessive beam deformation

Beam/slab deflection does not in itself cause structural failure, unless it causes columns to buckle or joints to fracture.

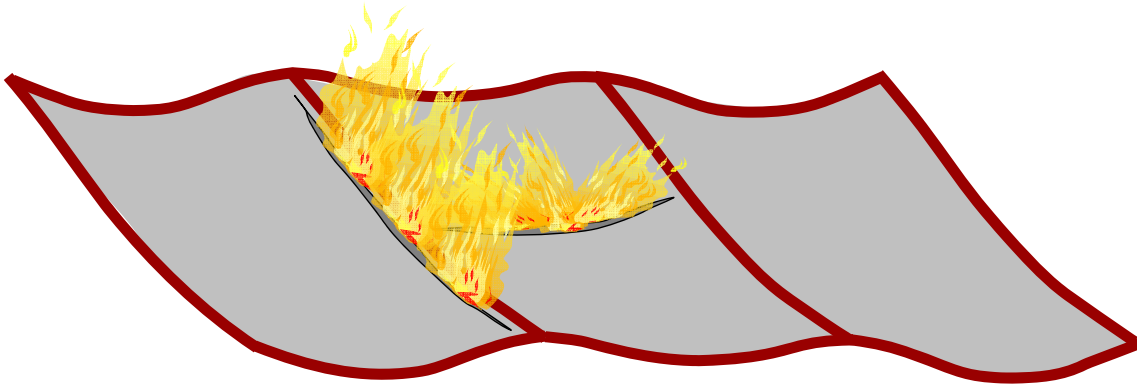

It may cause compartmentation integrity failure which allows fire to spread.

13



Column buckling

14



Column buckling

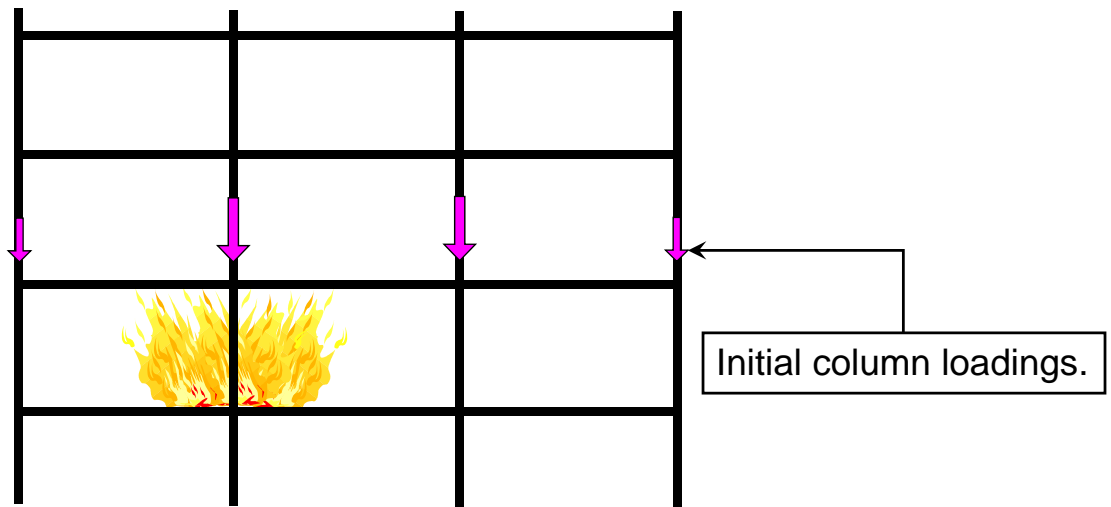

Column buckling

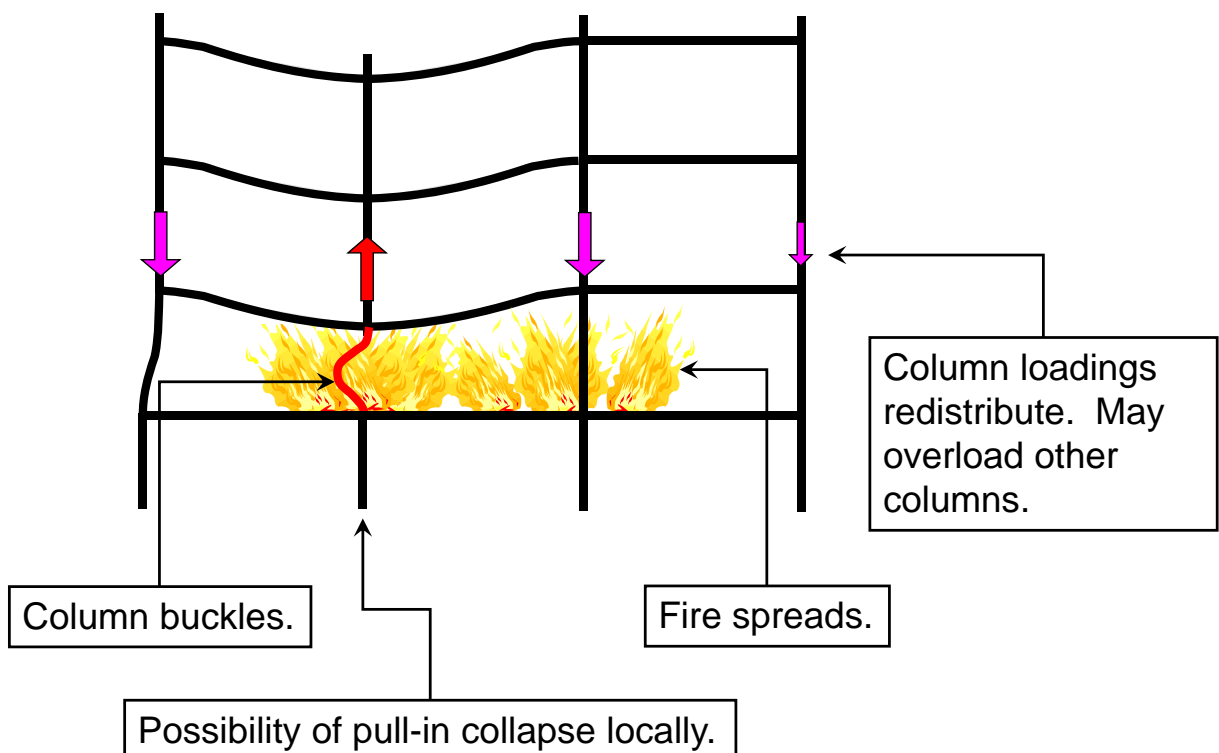



Column buckling

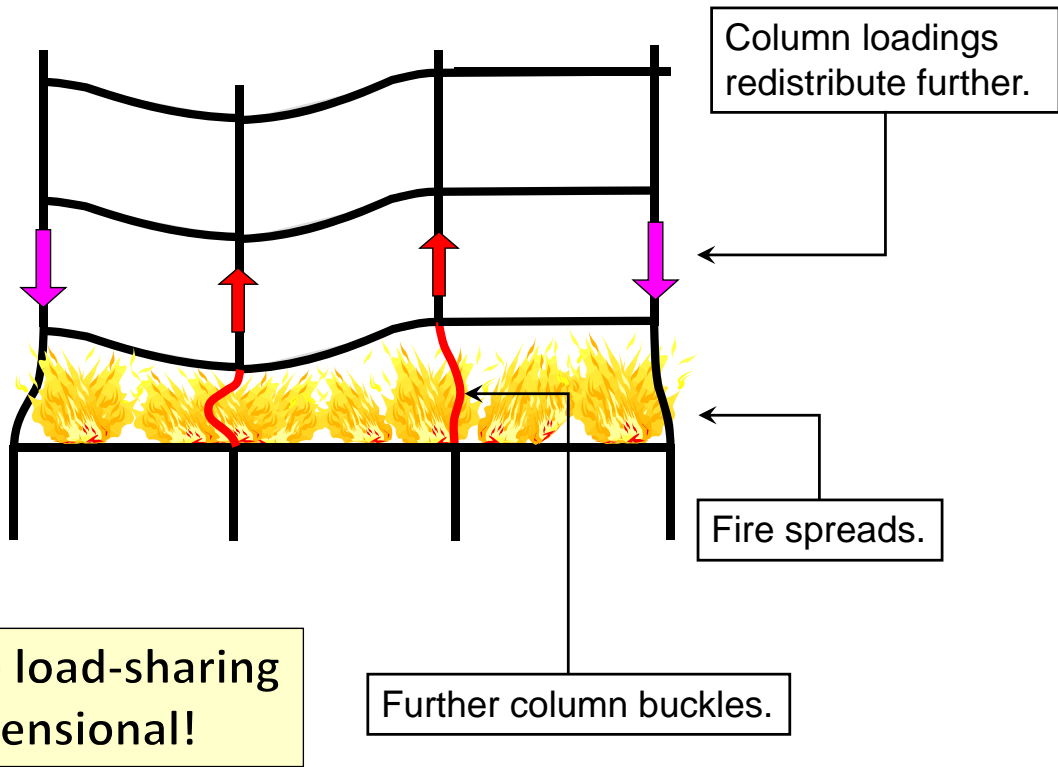

Column buckling

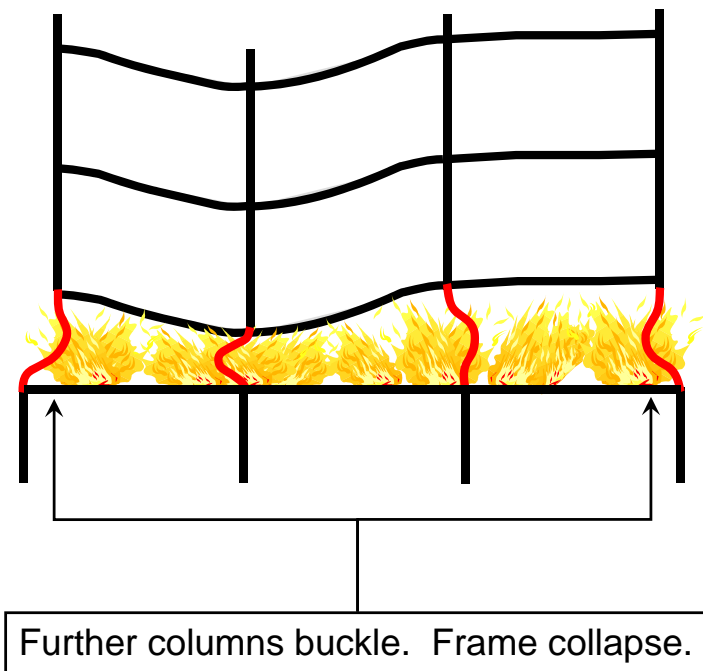

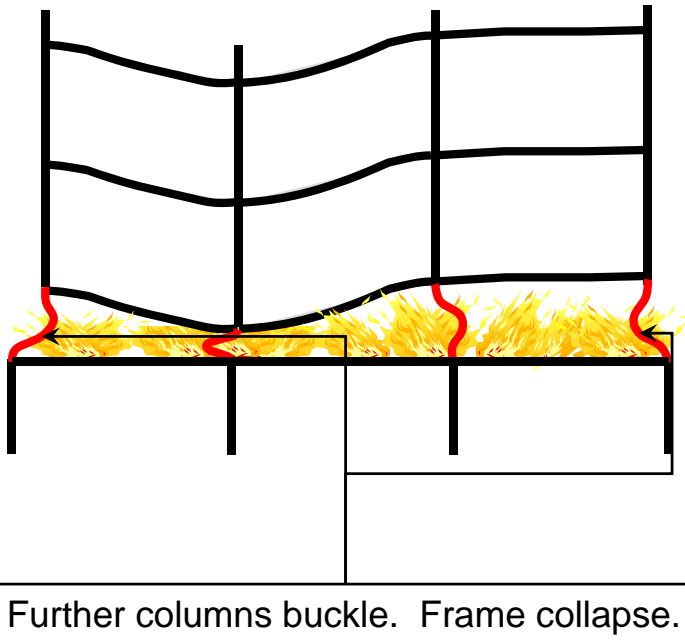

Consequences of column buckling in fire

- Loads are redistributed to adjacent columns – similar to “column-out” scenario in blast-resistant design.
- A single column collapse may lead to severe local collapse.
- May be mitigated to some extent by 2-dimensional redistribution via slabs.
- If these are also affected by temperature-dependent strength reduction there is a high probability of building collapse.
- Columns should be designed for fire resistance with care. Passive protection is usually required.



Interactive failure

Multi-storey fire spread

21



Vertical external fire spread

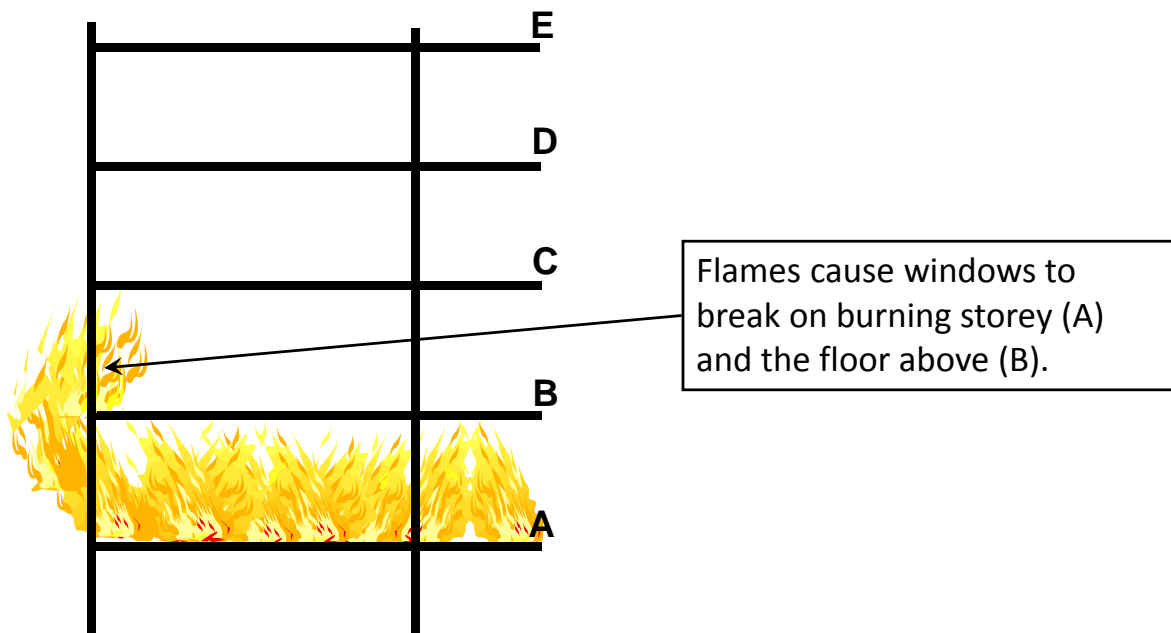

22



Vertical external fire spread

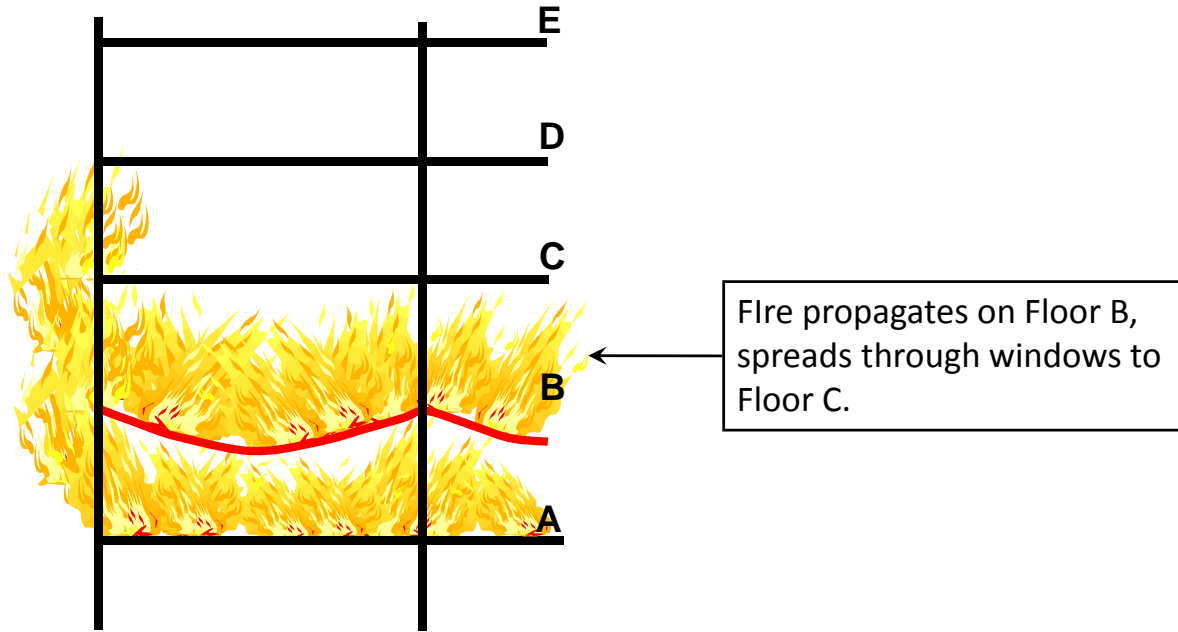

Vertical external fire spread

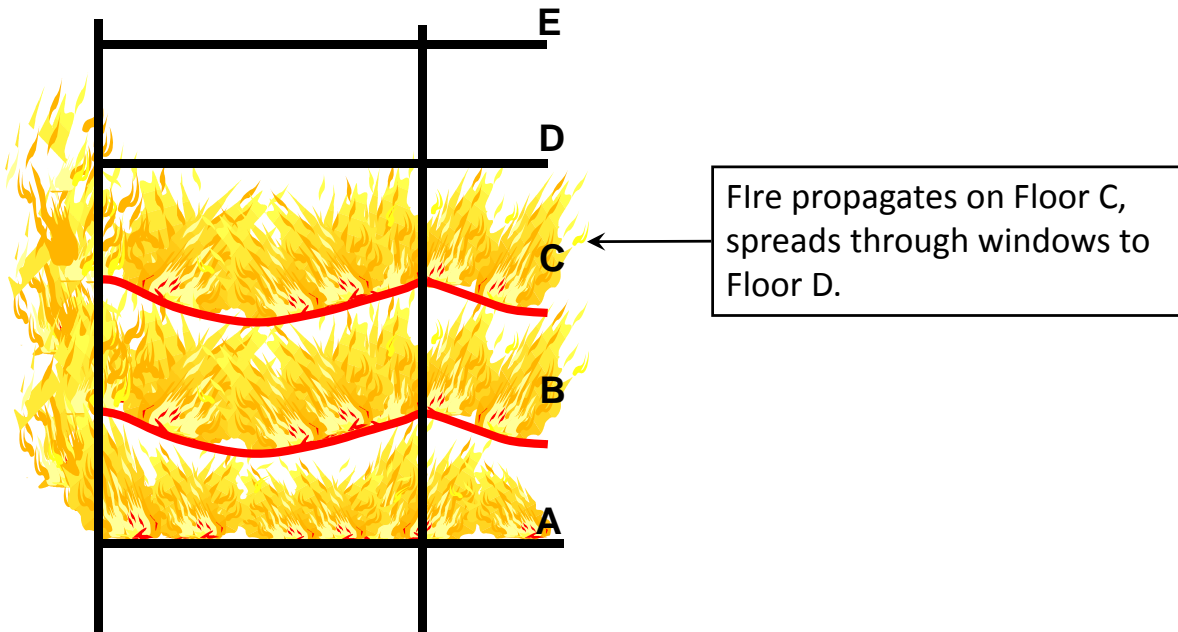



Pull-in-enhanced buckling of columns

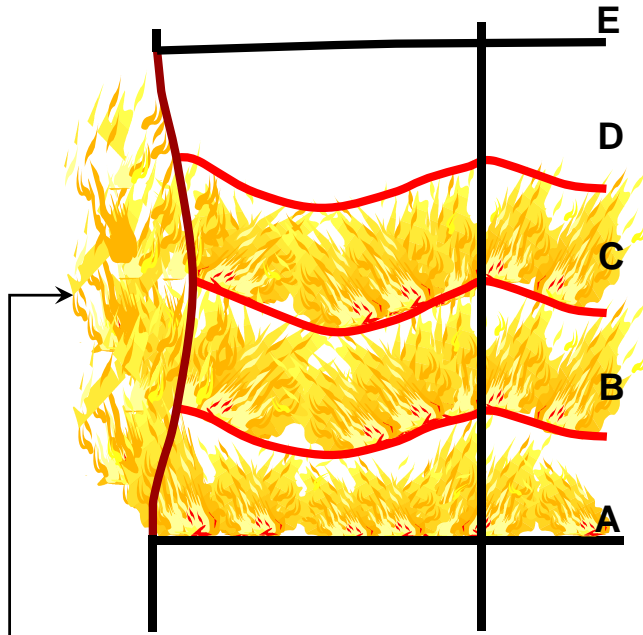

- Heated beams “pulling” on column
- Greatly increased effective length
- Column itself weakened by heating

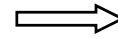

Inward buckling of column. Partial or overall collapse.



WTC 1: Observed column pull-in

WTC 1 exterior columns bowing inward across most of the south face between floors 95 to 98 at 10.23 am.

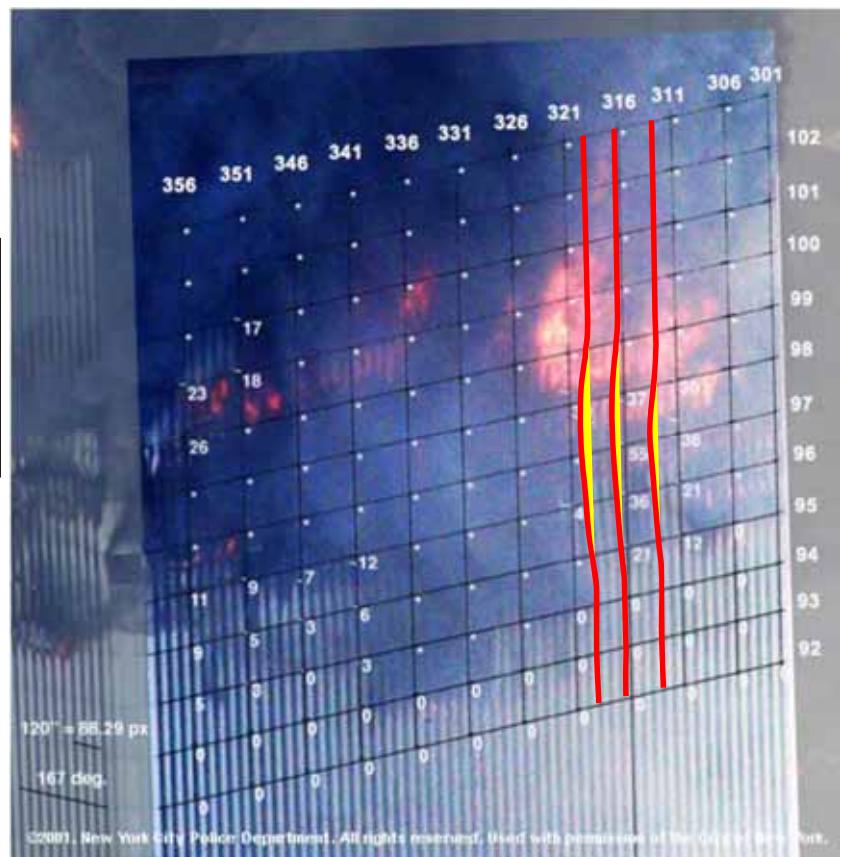



Perimeter wall analysis found “... an inward pull force of 27kN at each column at floors 95 to 99, starting 80 minutes after the aircraft impact, caused a maximum inward bowing of 790mm. “

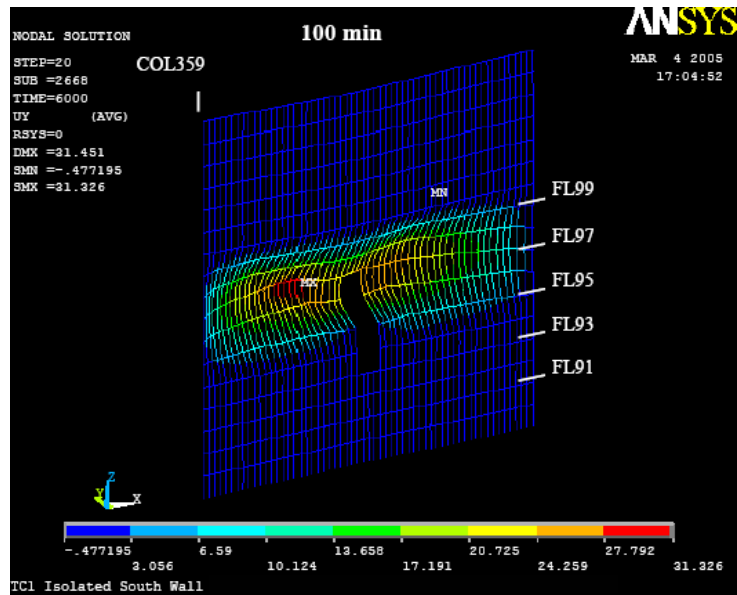

Catenary forces on connections WTC 1 and 2 floor trusses



Connection force in WTC floor model: ISO834 fire

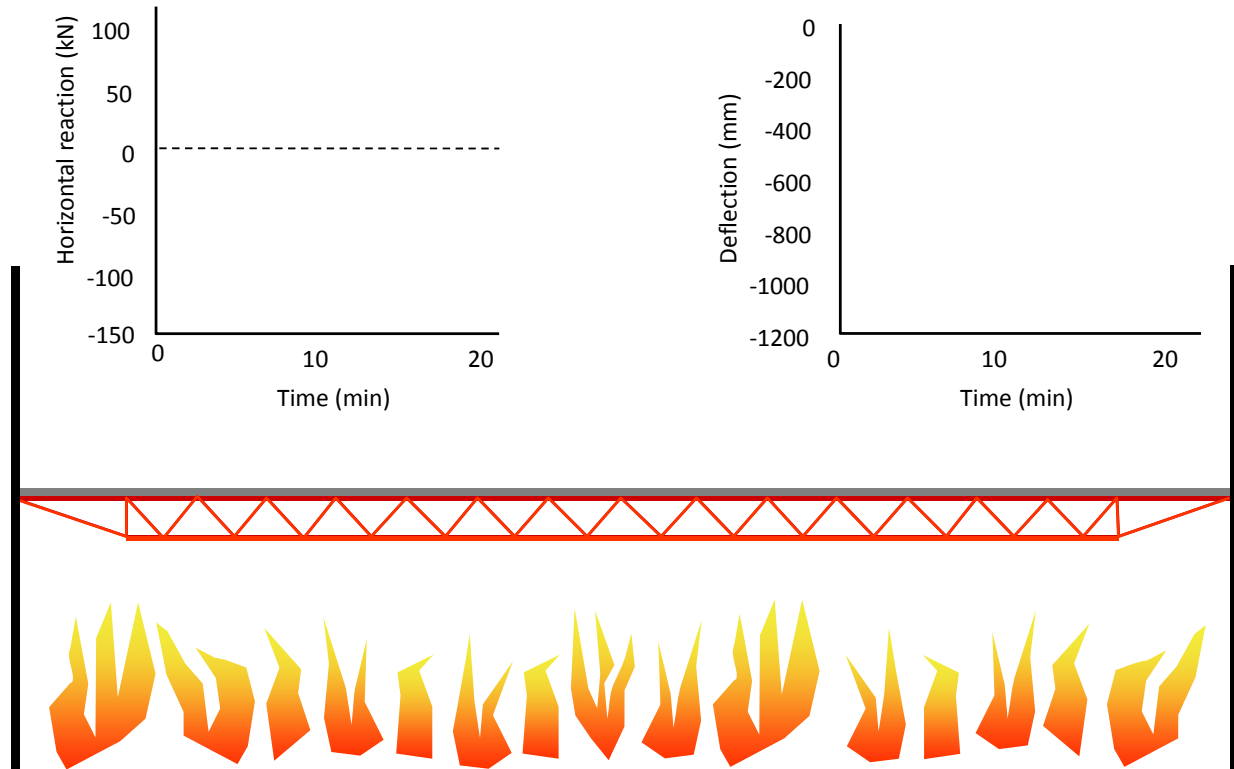

29



Connection force in WTC floor model: ISO834 fire

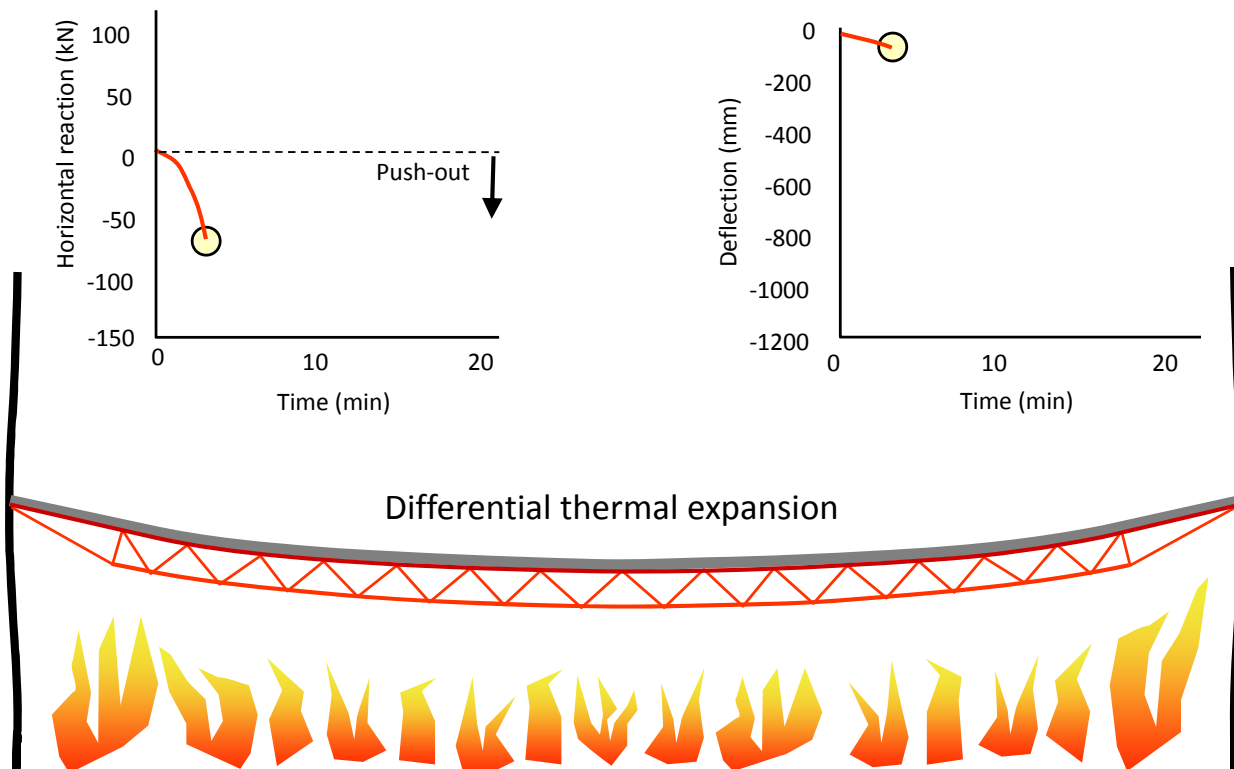

30



Connection force in WTC floor model: ISO834 fire

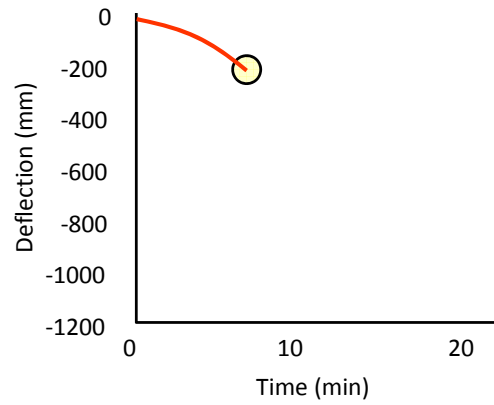
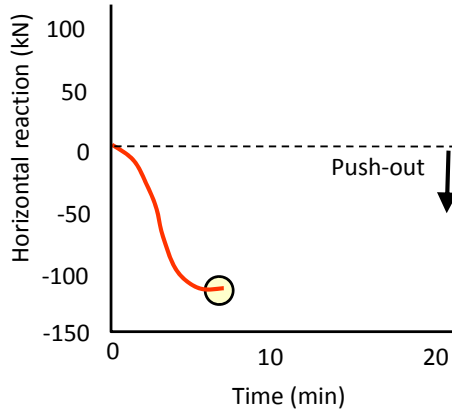

Yield of mid-span bottom chord

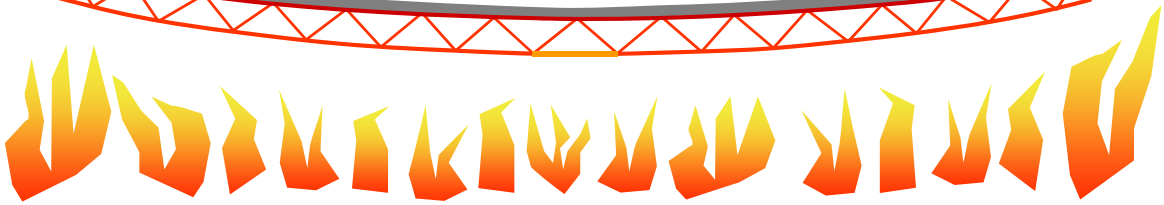

31



Connection force in WTC floor model: ISO834 fire

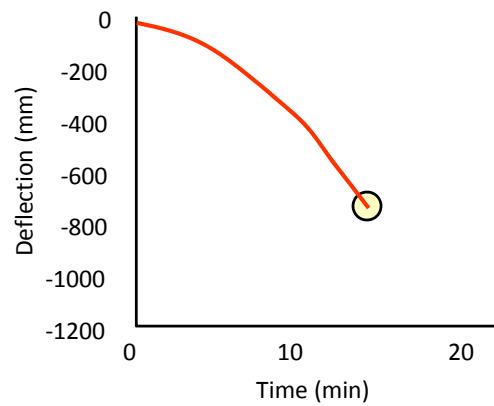
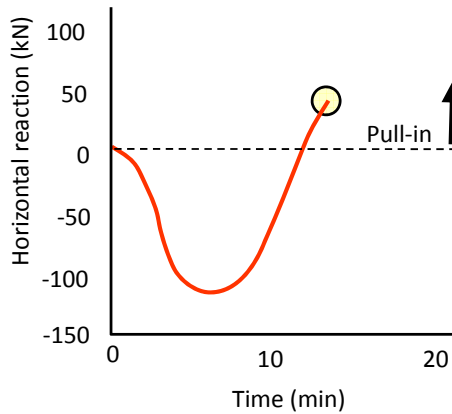

Yield of mid-span bottom chord

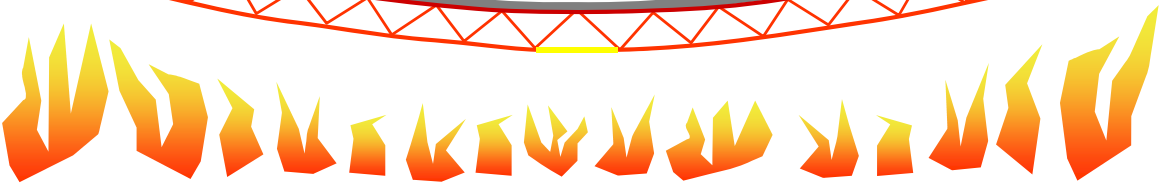

32



Connection force in WTC floor model: ISO834 fire

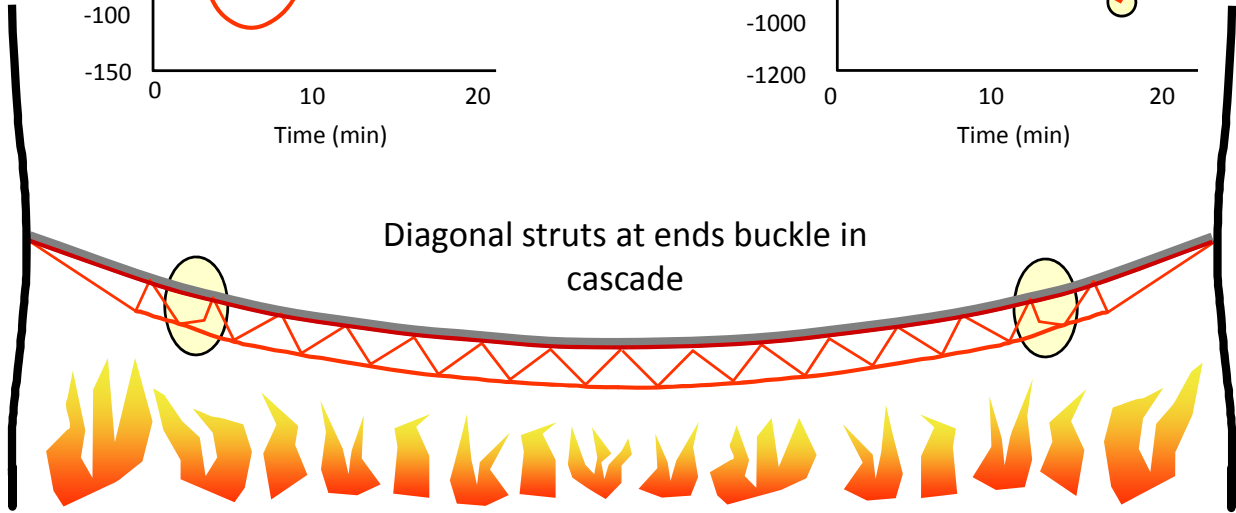
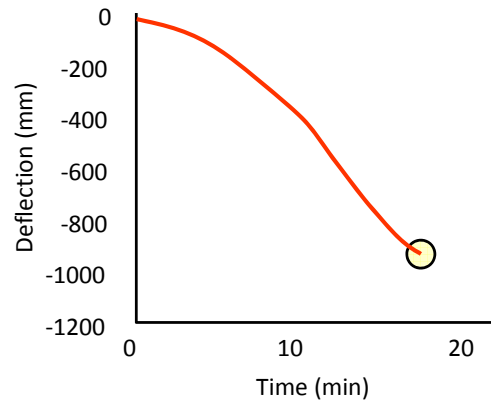
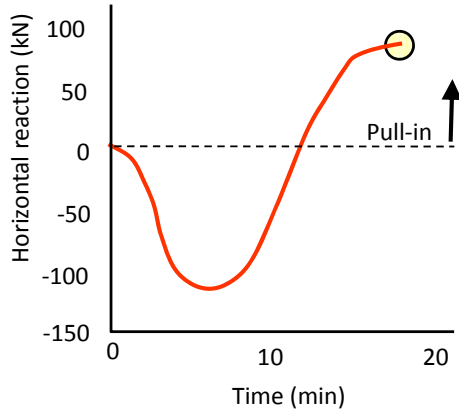

Connection force in WTC floor model: ISO834 fire

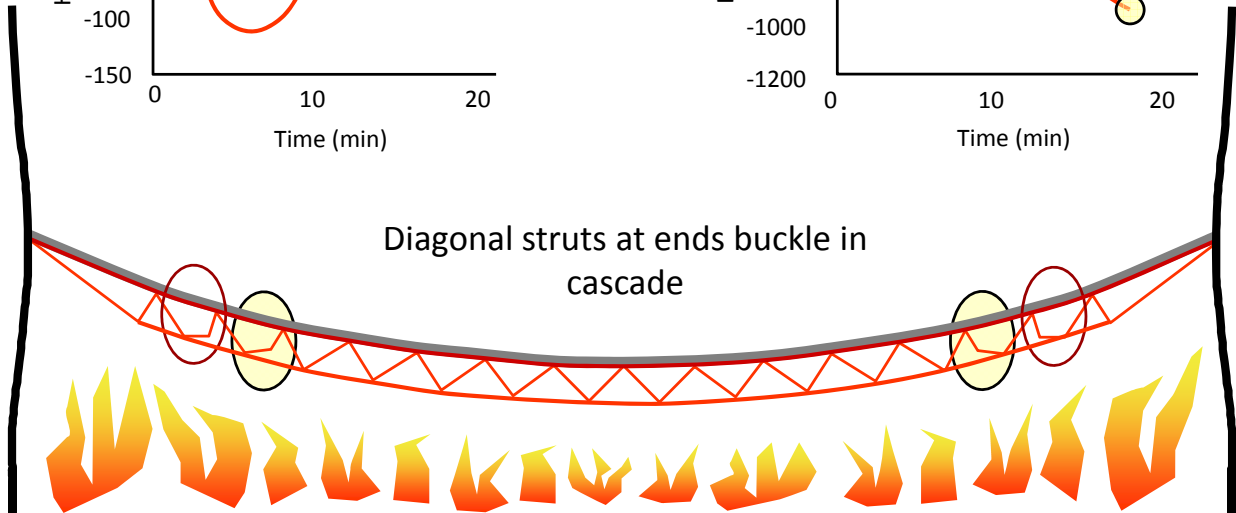
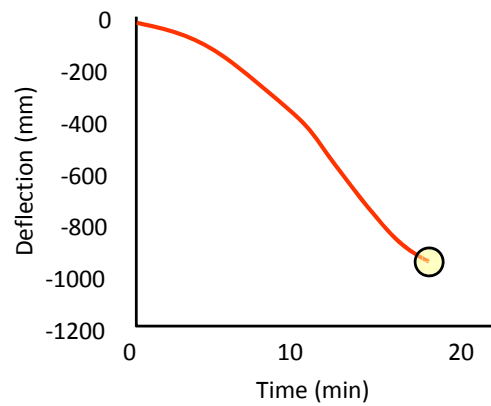
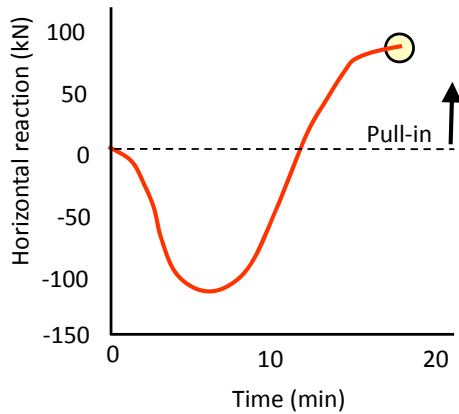



Connection force in WTC floor model: ISO834 fire

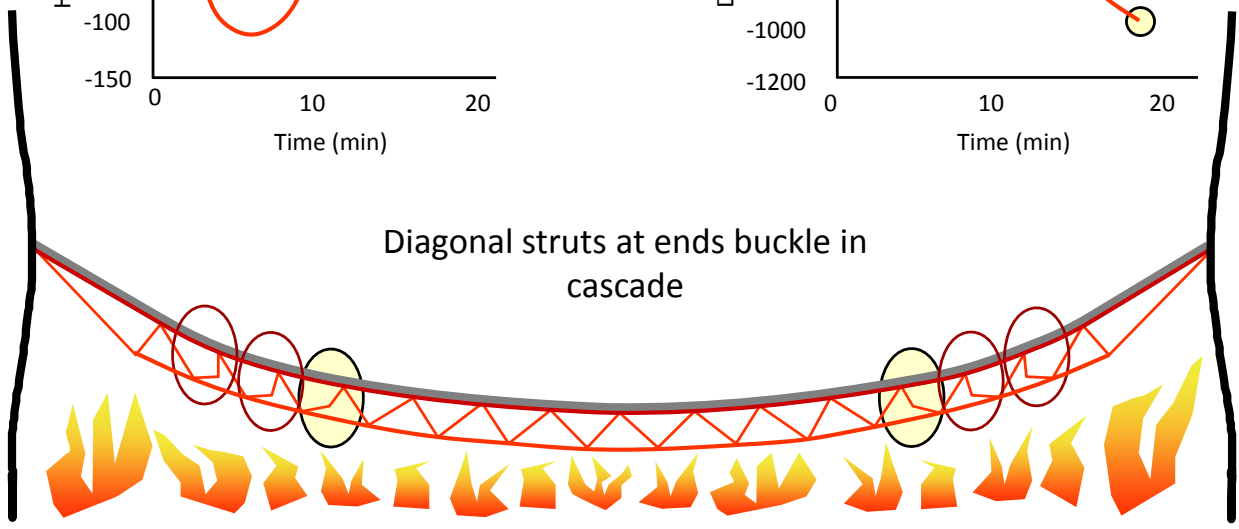
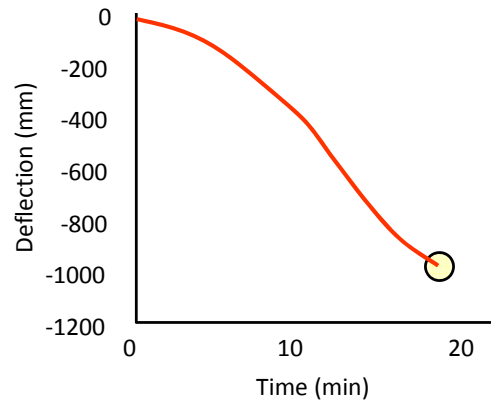
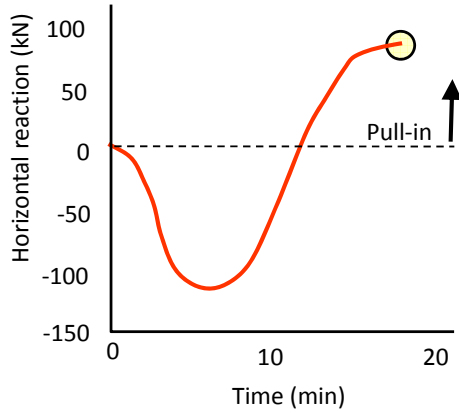

Connection force in WTC floor model: ISO834 fire

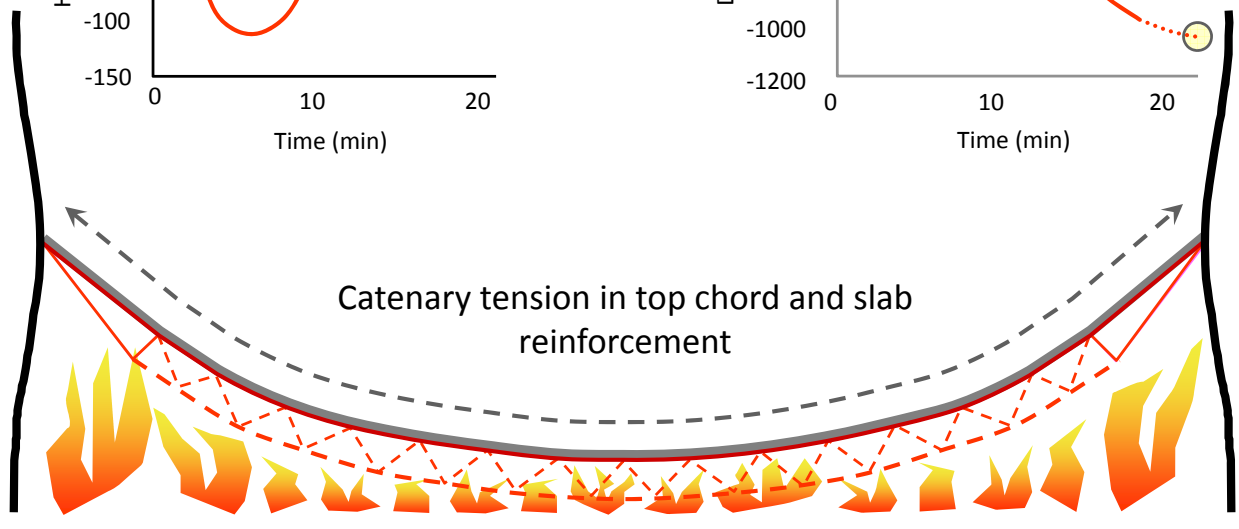
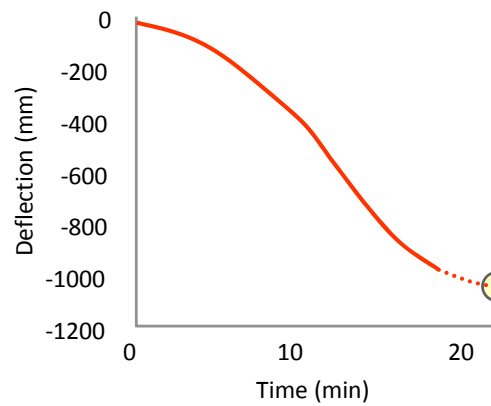
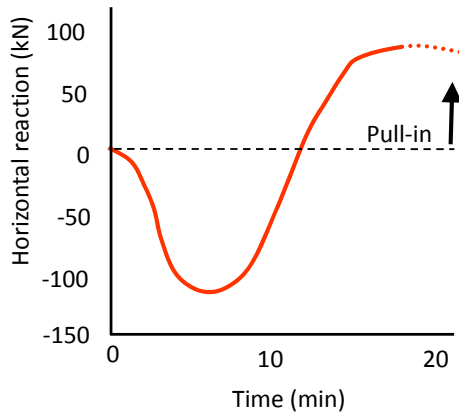



Tying forces on connections

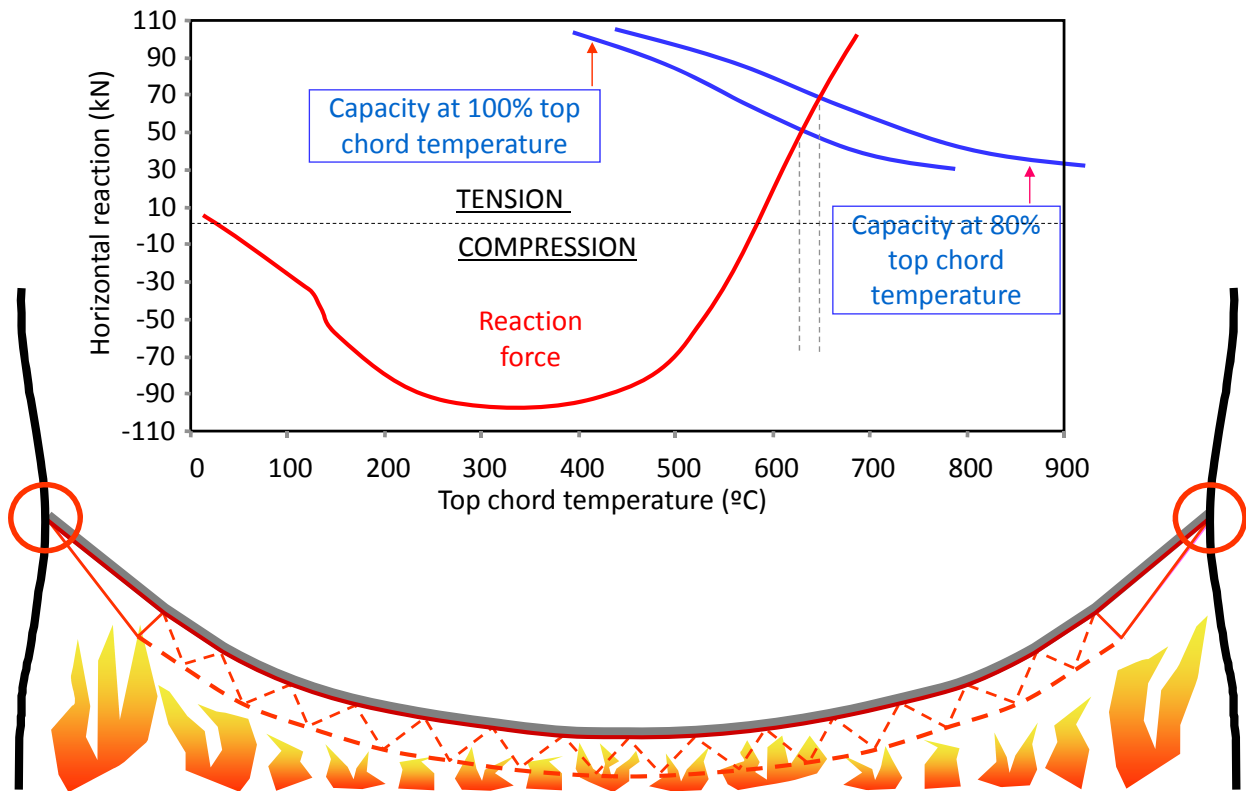

37



Consequences of interactive failure

Possibility of major structural failure.

However ...

It needs several aspects ...

- Fire spread,
- Beam/Slab deflection,
- Column weakening

... to come together.

If fire spread is predictable, the structural interaction can be modelled by software.

38



Connection fracture

39



Connection fracture

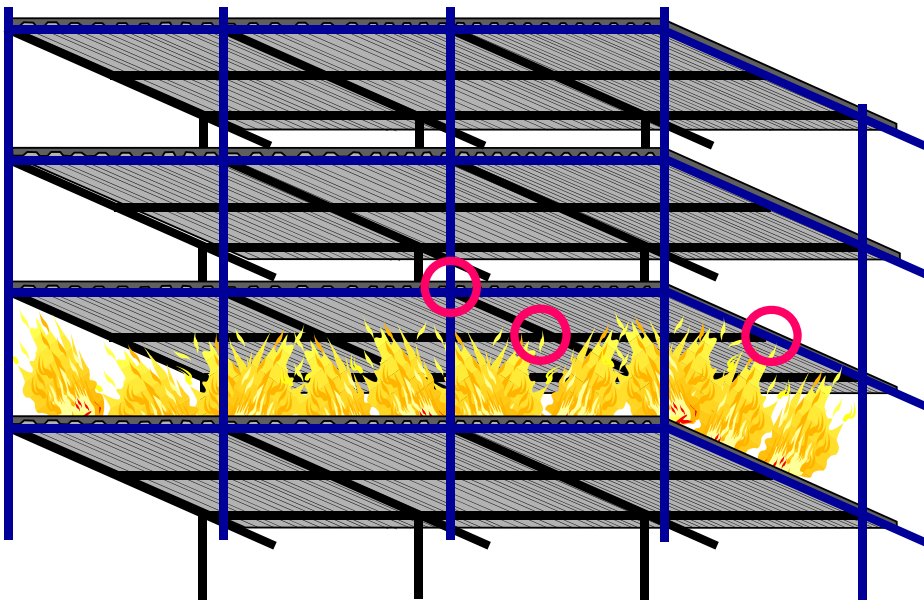

40



Generation of connection failure

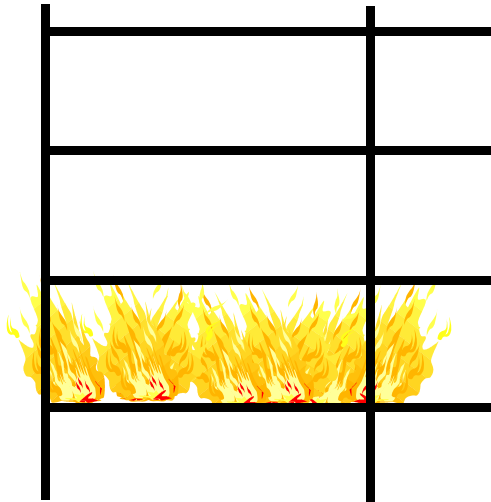

41



Push-out force

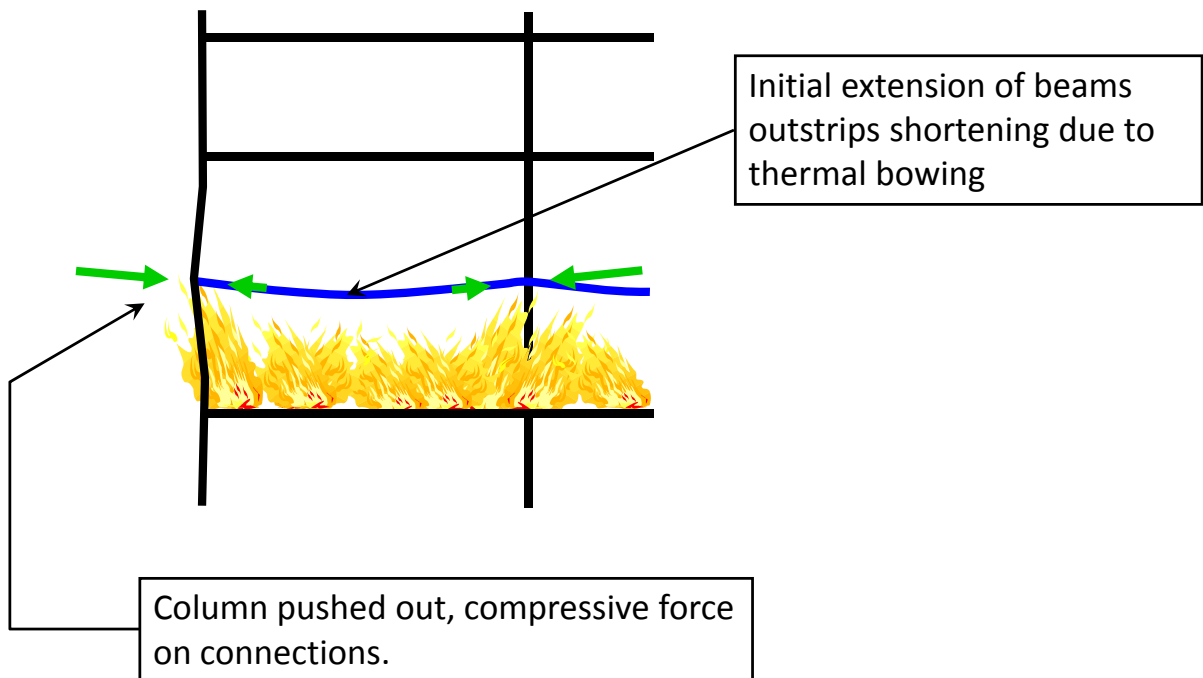

42



Cardington Beam-Column Joint Fire Test 7



Beam shear buckling

Beam flange buckling



Connection tying force

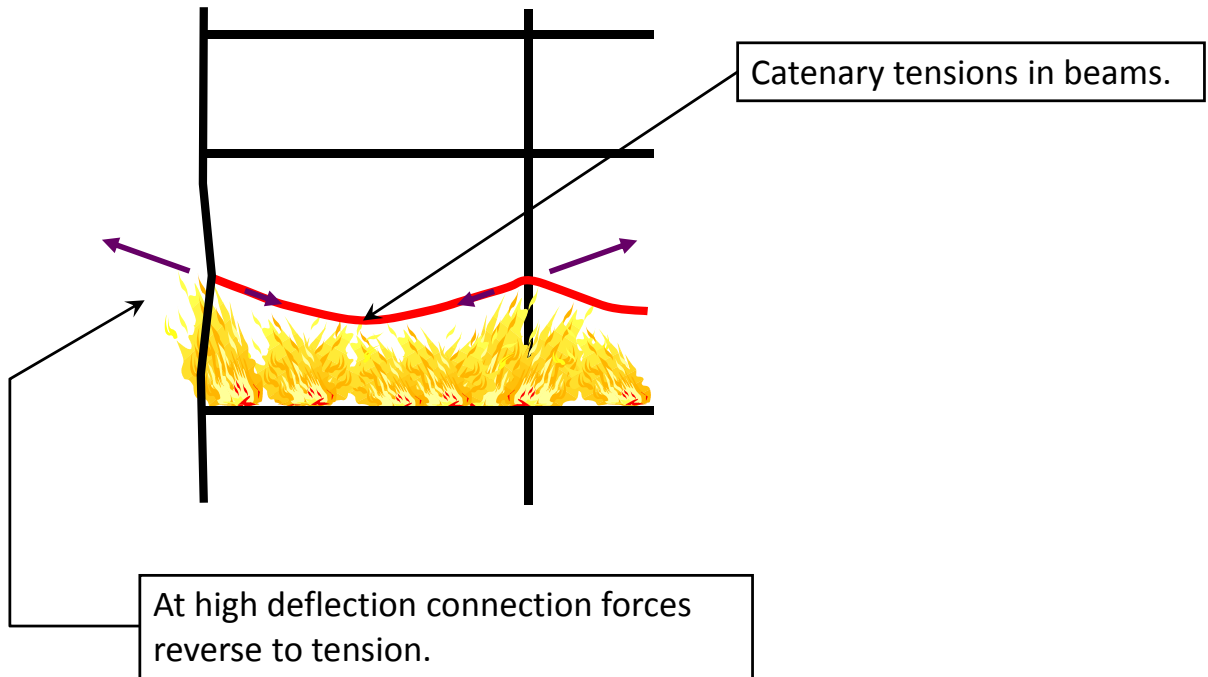



Vertical fire spread

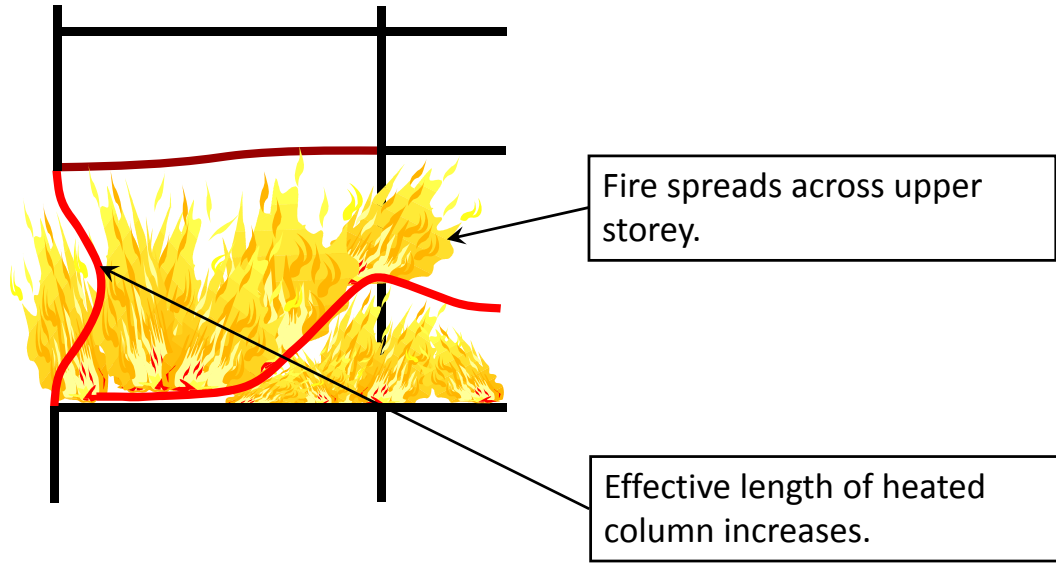

Connection fracture

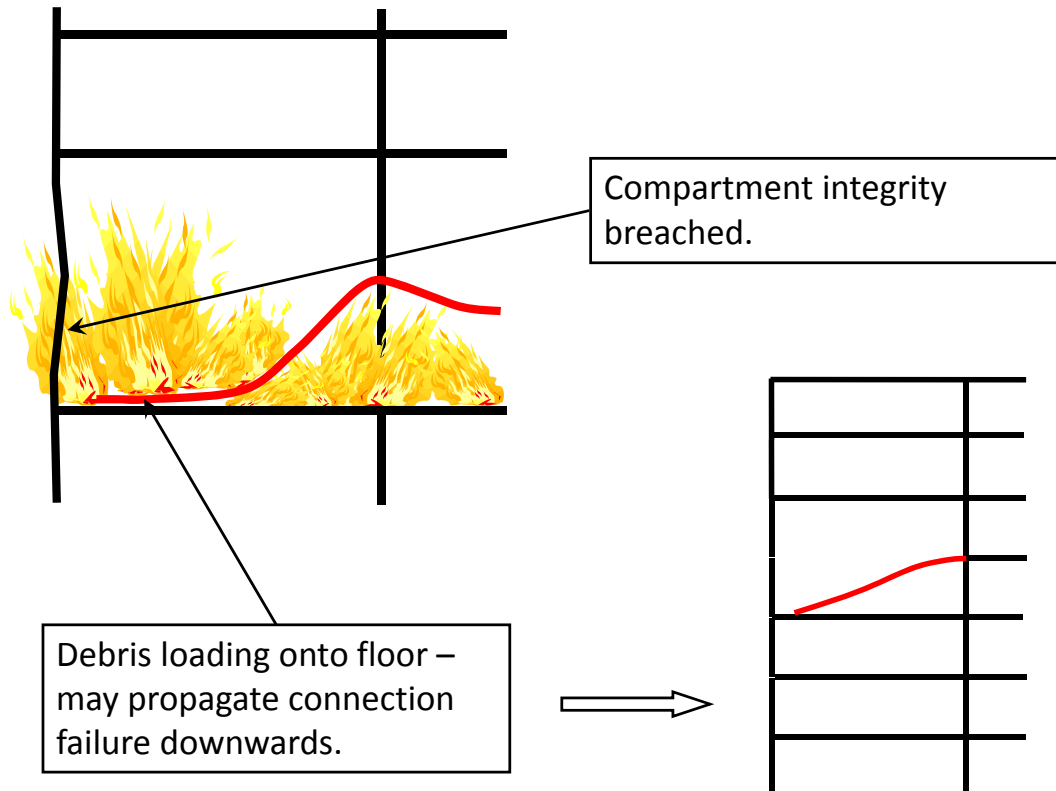



Connection fracture

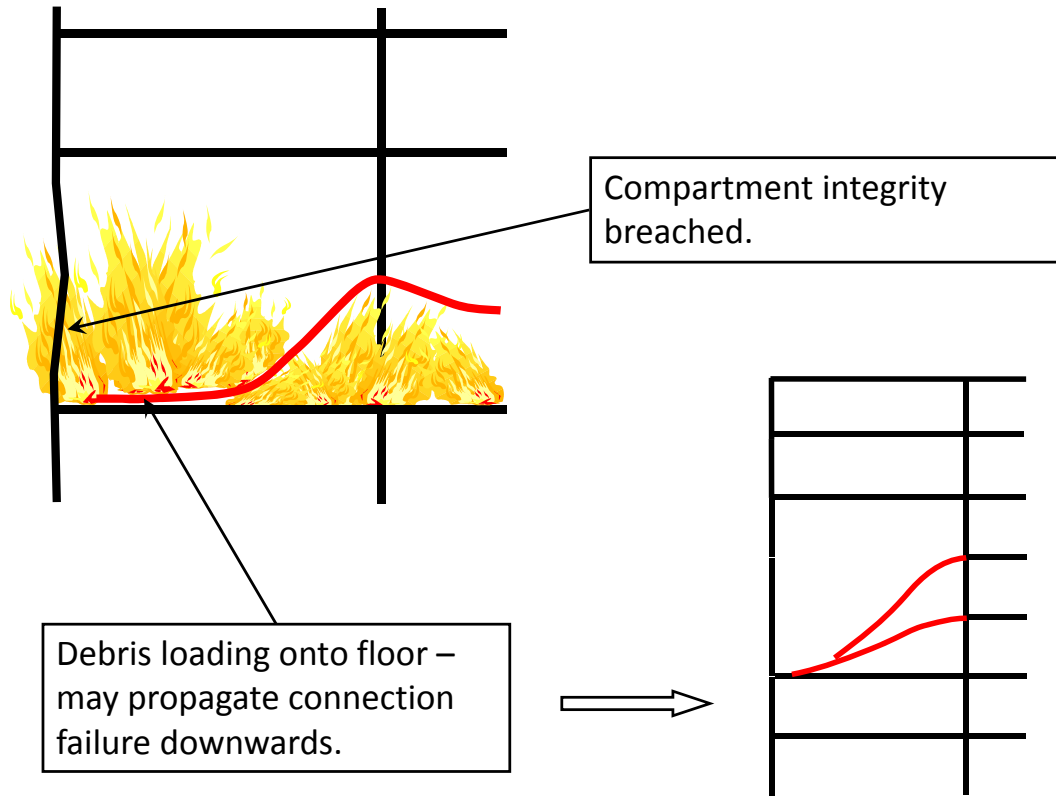

47



Connection fracture

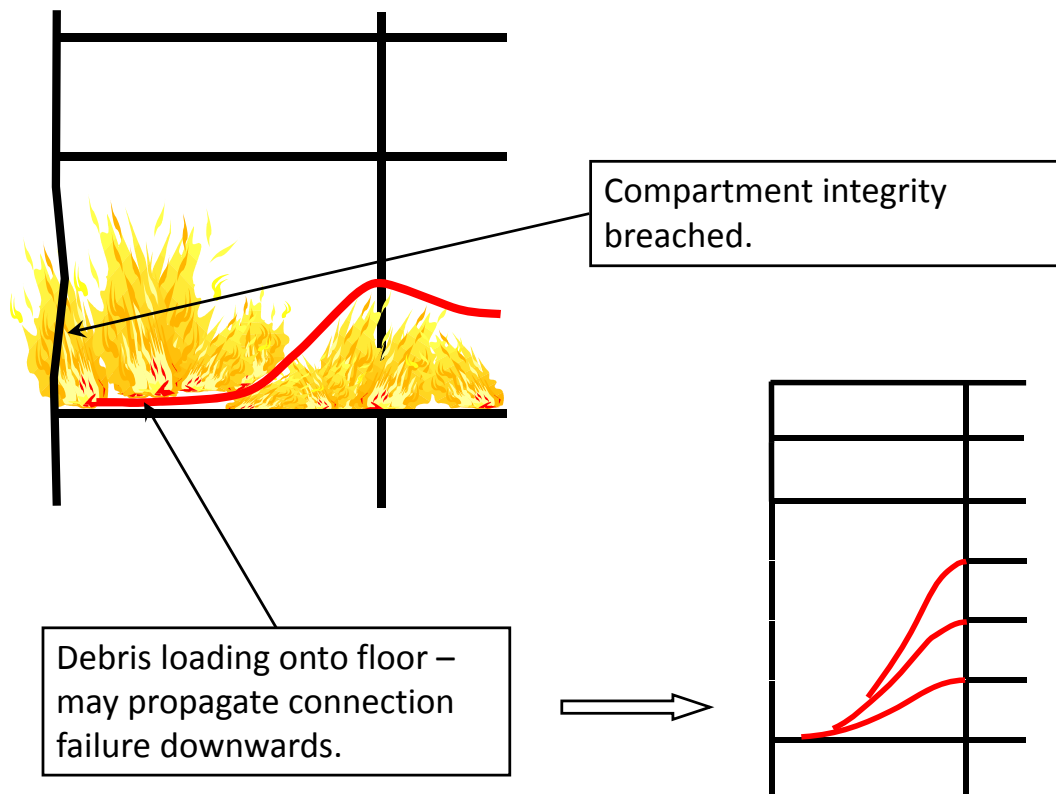

48



Connection fracture

Consequences differ:

- Columns are key elements – failure may be disastrous.
- Joint failure may initiate fire spread and progressive collapse.

Compartment integrity breached.



Debris loading onto floor – may propagate connection failure downwards.

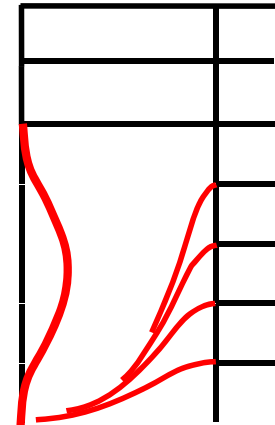
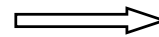

Axial force in steel downstand of composite beam (Ding & Wang)

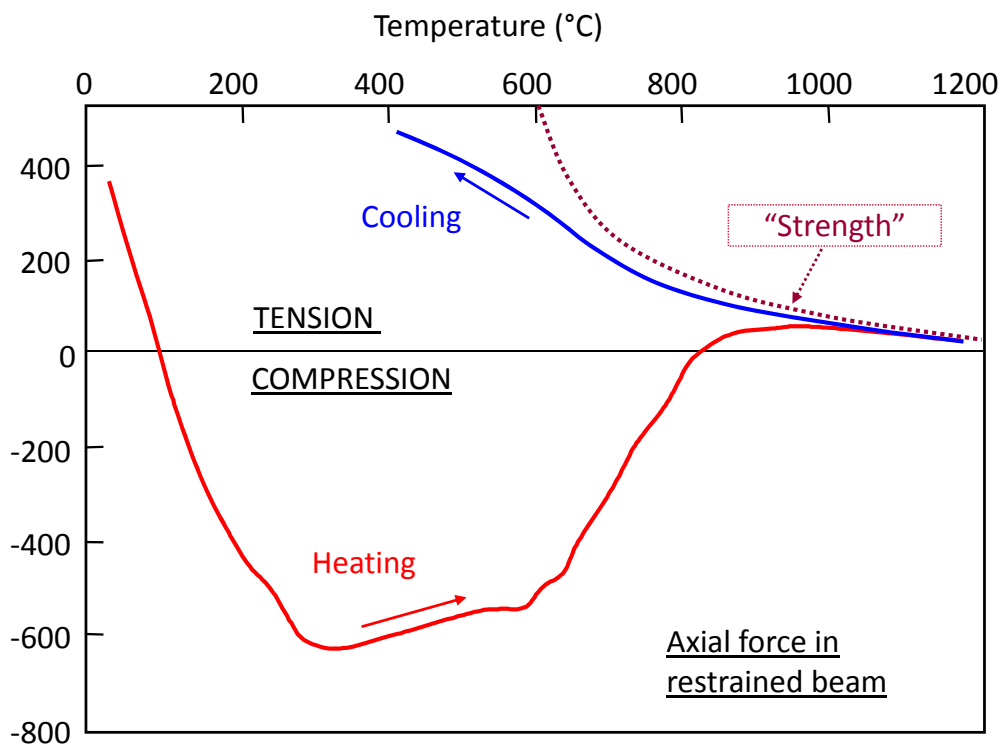



Joint failures in cooling

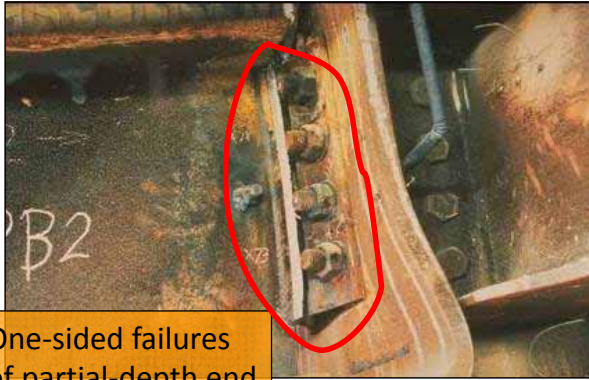

One-sided failures of partial-depth end plates

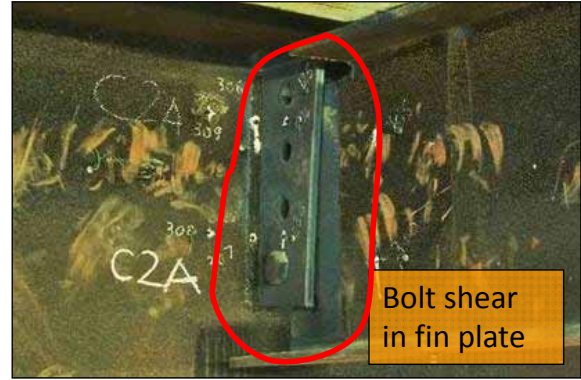

Bolt shear in fin plate

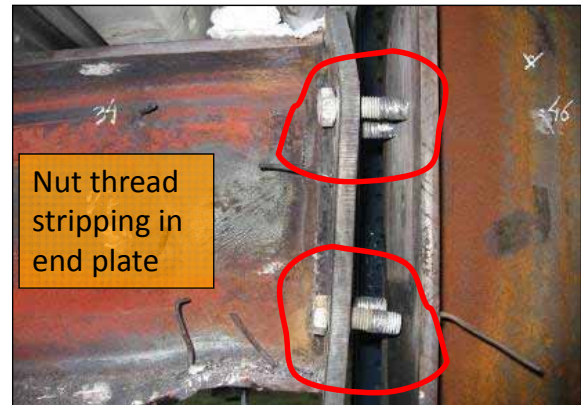
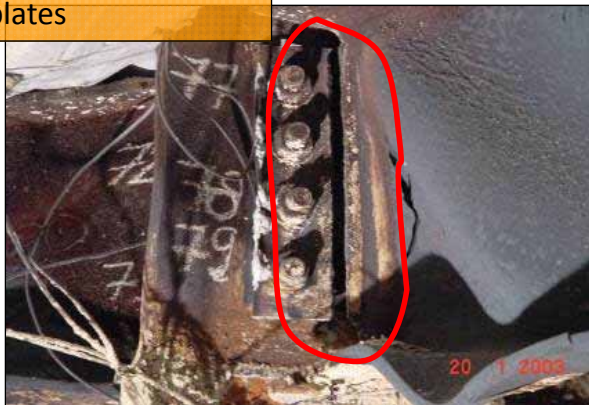

Nut thread stripping in end plate



Fracture in cooling at Cardington

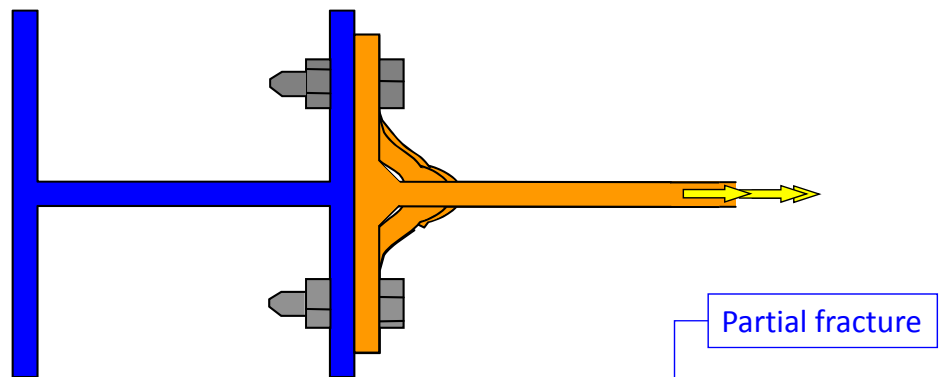

- One-sided failure of partial-depth end plates during cooling phase.
- Reduced stiffness retains joint integrity.
- Partial fracture may happen when cooling from net compression ...

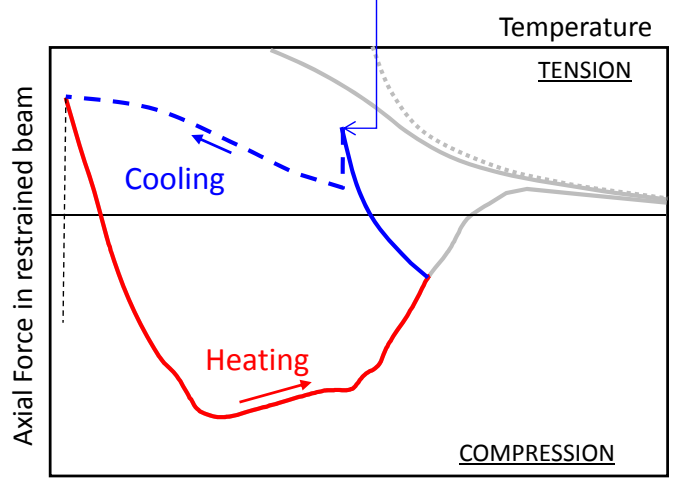



What are the consequences of connection failure in fire?

WTC 7

53



WTC 7 after the fall of the twin towers



54



Sequence of events on September 11, 2001

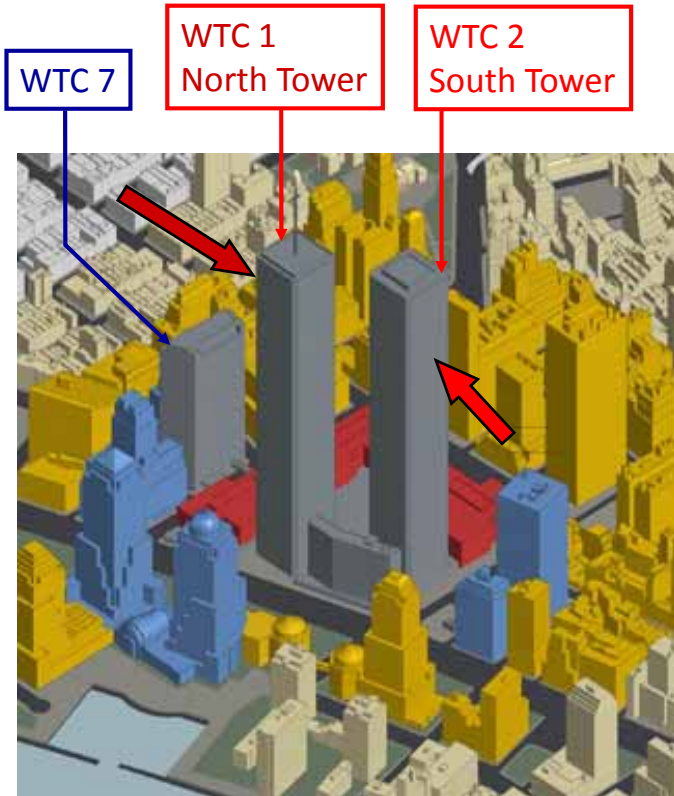

Time	Event
08:46	WTC 1 Impact ~92 nd floor Boeing 767-200, 750 km/h
09:03	WTC 2 Impact ~78 th floor Boeing 767-200, 945 km/h
09:59	WTC 2 Collapse
10:28	WTC 1 Collapse; other building impacts
17:20	WTC 7 Collapse

55



Simulated fire progress on Floor 12

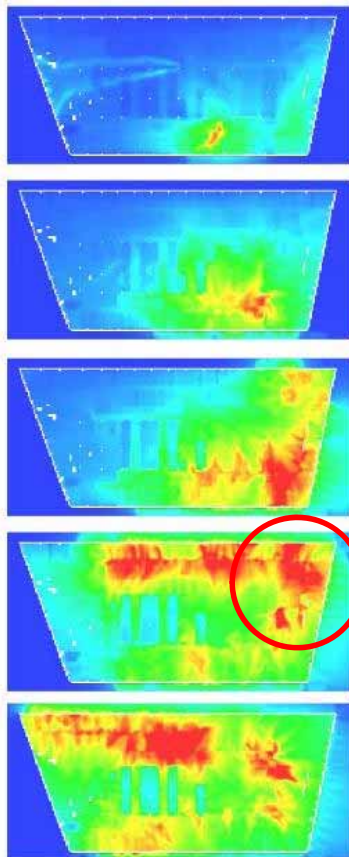

1:00 p.m.

2:00 p.m.

3:00

4:00

5:00

Fires ignited on up to 10 floors at similar times.





Typical floor beam & column layout

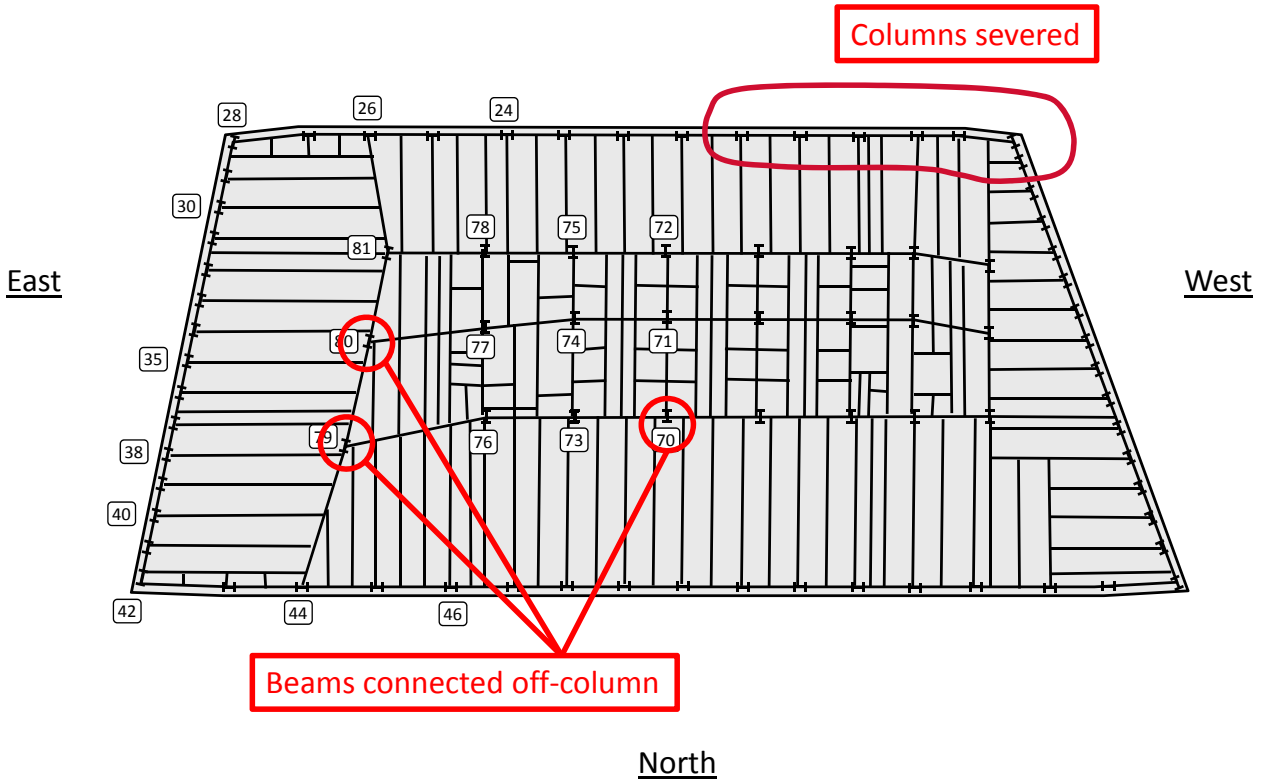

Floor structure around Column 79

Composite (secondary) beams with shear studs into slab.

Girders (primary beams) are non-composite (no shear studs).

Only 3 girders connected to Column 79.

Composite beams frame into girders close to column.

Beam spans in North-East corner zone about 15m in length.

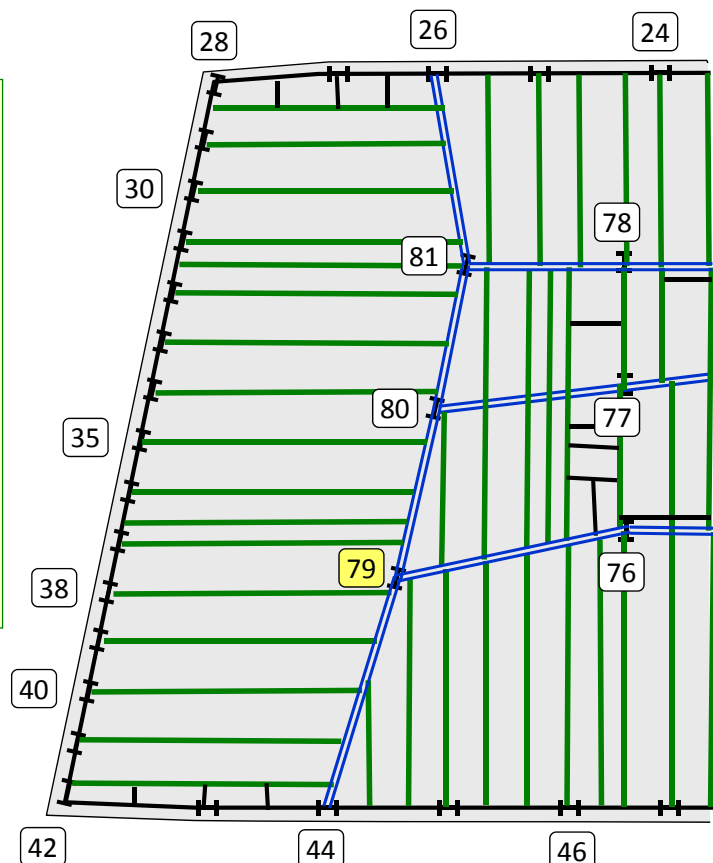



Heating of structure around Column 79

Between floors 7-14 fires were sustained but moved around the floors in different directions.

In mid-afternoon fires were observed simultaneously around the North-East corner of the building on these floors.

Fire protection on beams and columns was probably intact.

Beams probably achieved 600°C in places on Floors 8, 12, 13, 14, and 400°C in places on Floors 9, 10,

Interior columns all probably stayed below 200°C.

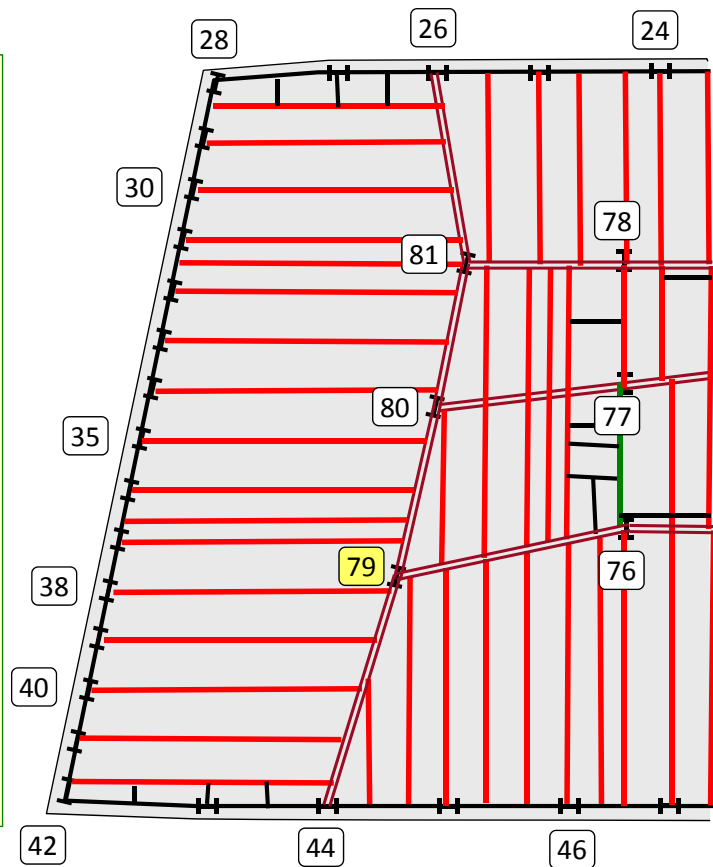

Floor structure around Column 79

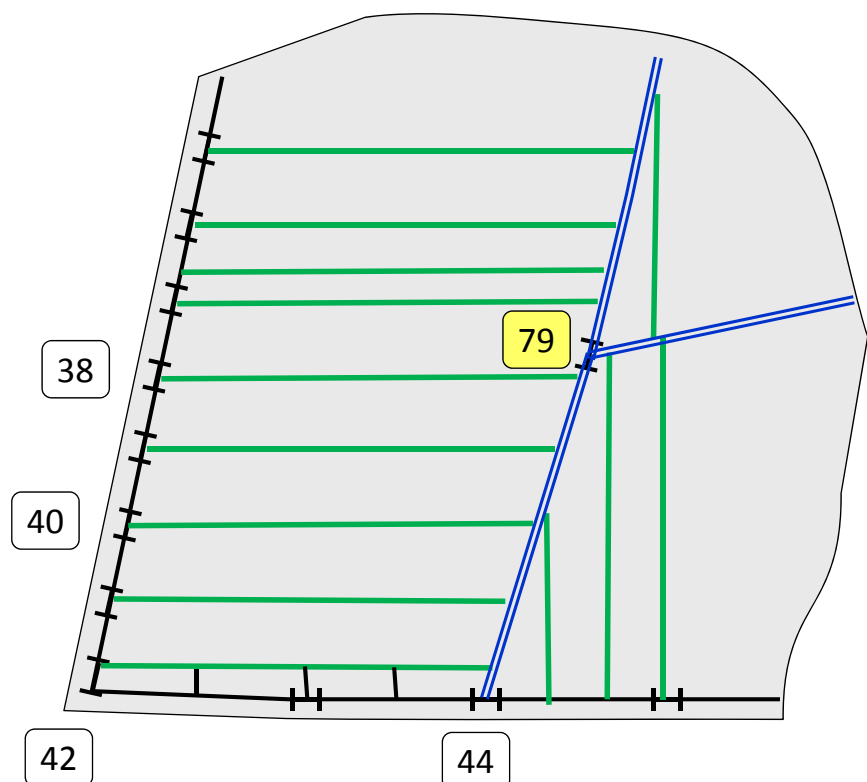



Floor structure around Column 79

At $\sim 500^{\circ}\text{C}$ a 15m composite (secondary) beam has a free thermal expansion of $\sim 90\text{mm}$.

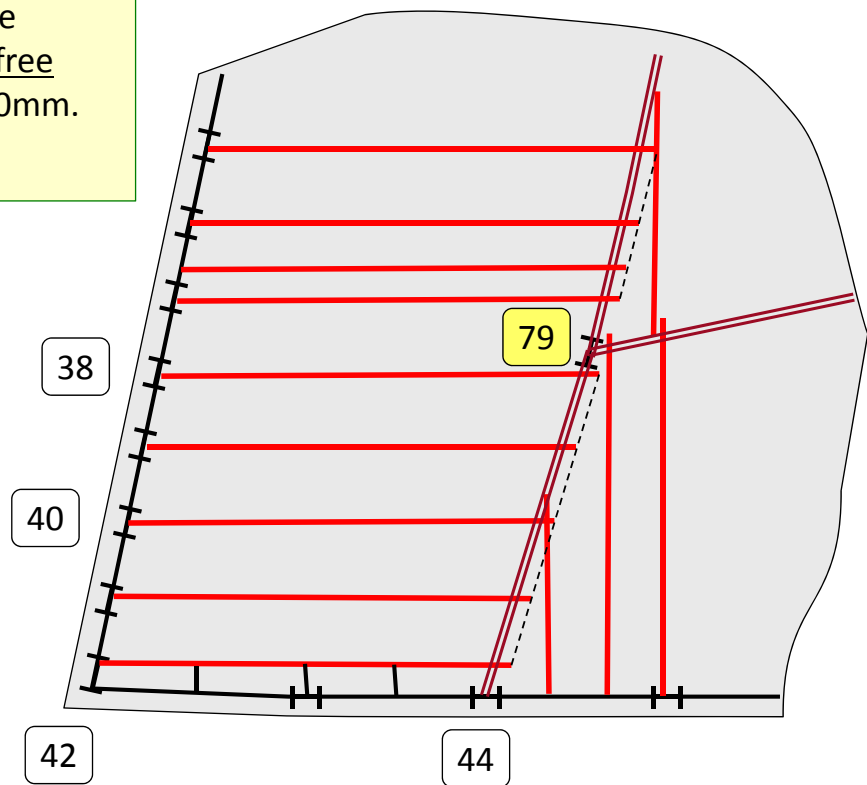

Floor structure around Column 79

At $\sim 500^{\circ}\text{C}$ a 15m composite (secondary) beam has a free thermal expansion of $\sim 90\text{mm}$.

If this is restrained by the non-composite girder, it creates large transverse forces on the girder.

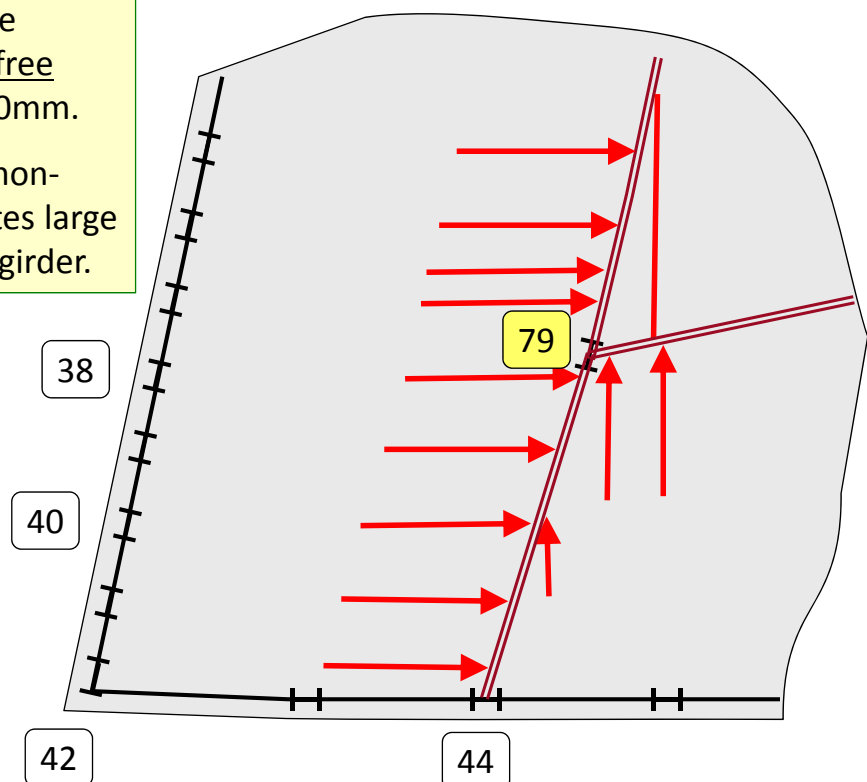



Floor structure around Column 79

At $\sim 500^{\circ}\text{C}$ a 15m composite (secondary) beam has a free thermal expansion of $\sim 90\text{mm}$.

If this is restrained by the non-composite girder, it creates large transverse forces on the girder.

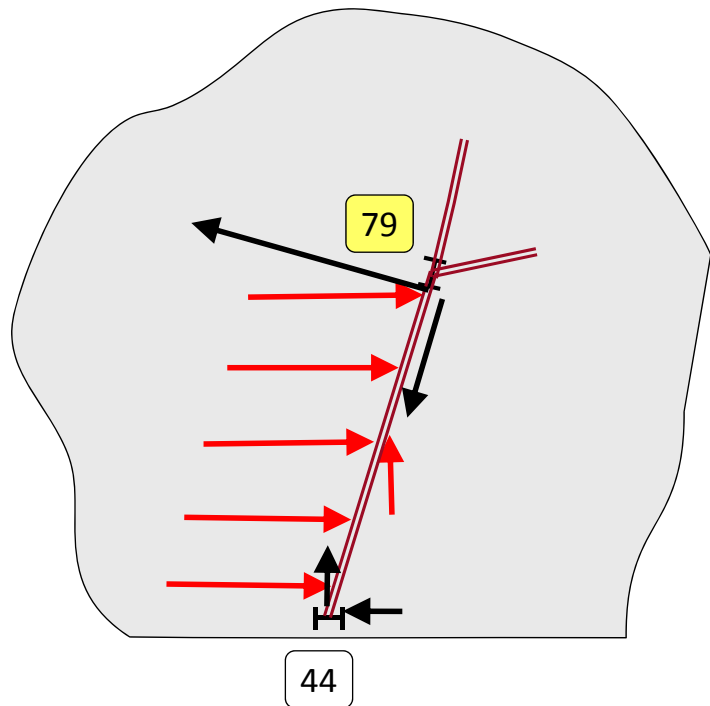

Girder to column connection at Column 79

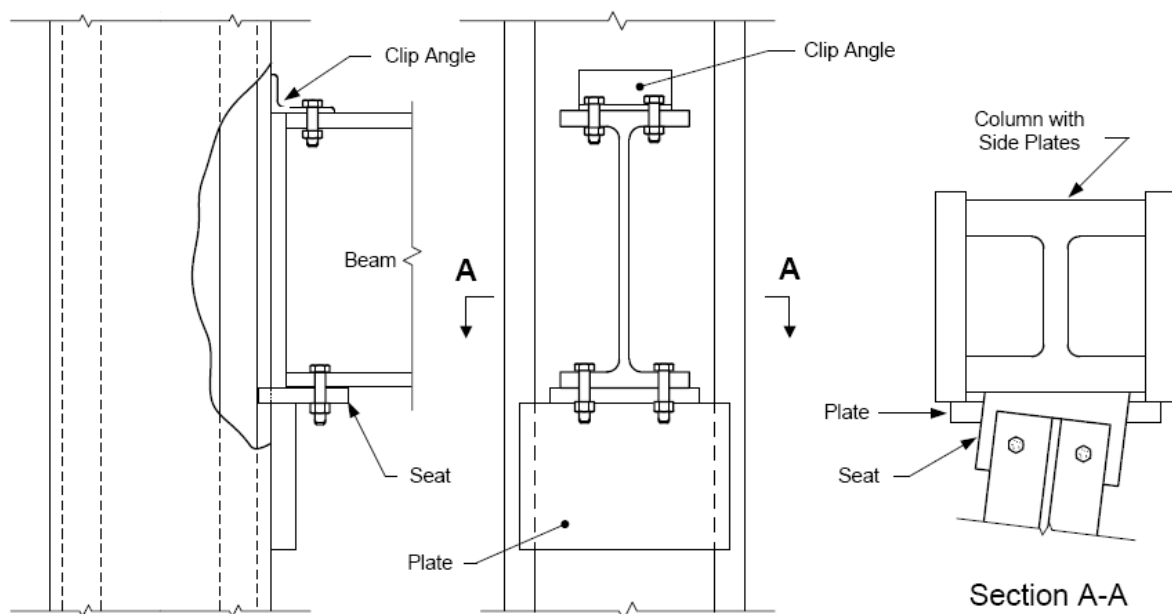



Girder to column connection at Column 79

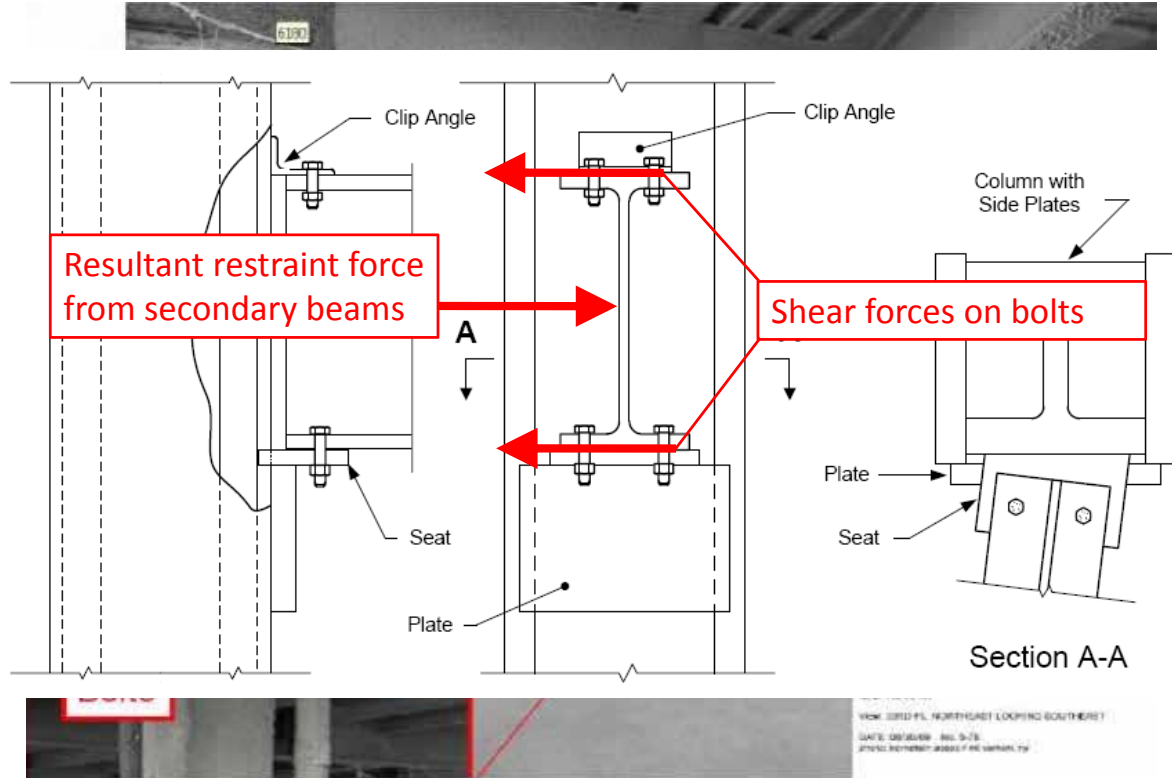

Floor structure around Column 79

At $\sim 500^{\circ}\text{C}$ a 15m composite (secondary) beam has a free thermal expansion of $\sim 90\text{mm}$.

If this is restrained by the non-composite girder, it creates large transverse forces on the girder.

Bolts on seating plate and locating cleat fracture in shear (probably on Floor 13), and the girder 44-79 collapses.

This is repeated in sequence on lower floors due to impacts and similar restraint forces from simultaneous fires.

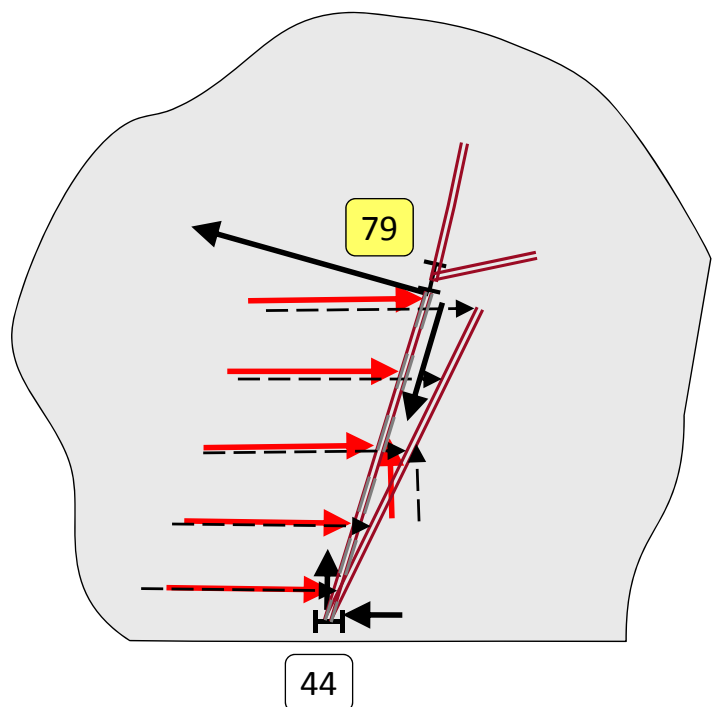

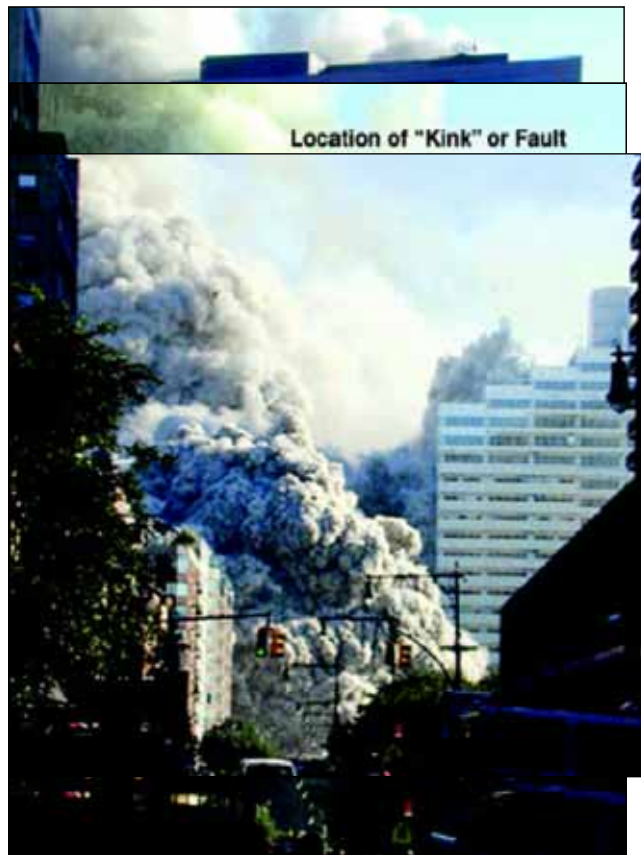

**Can we predict connection
behaviour in fire ??**



Principal component zones of end-plate

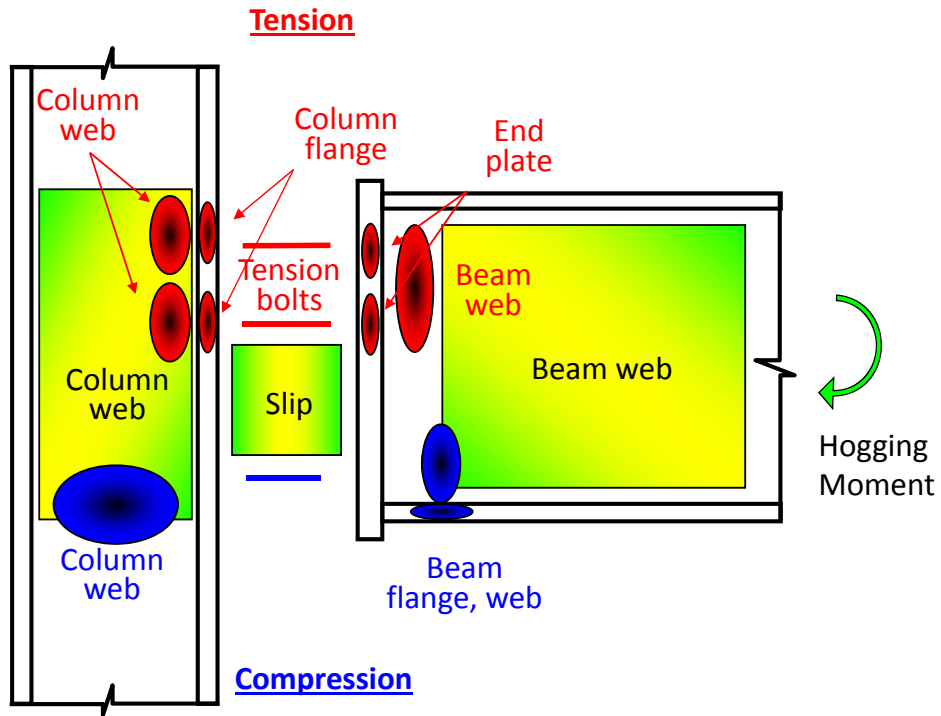

69



The "Component" method with axial force

- Component model deals with load combinations automatically, though M-f curves change due to thrust.

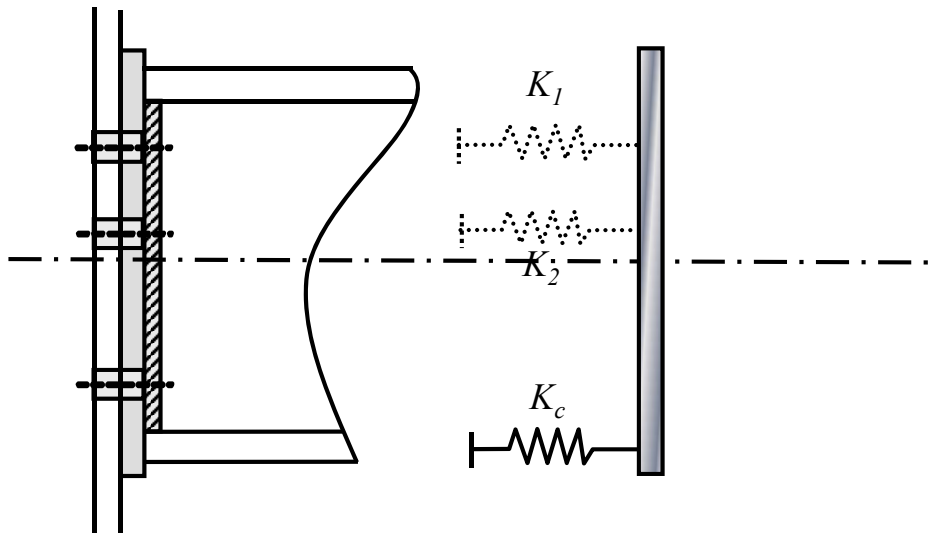

70



The "Component" method with axial force

- Component model deals with load combinations automatically, though M-f curves change due to thrust.

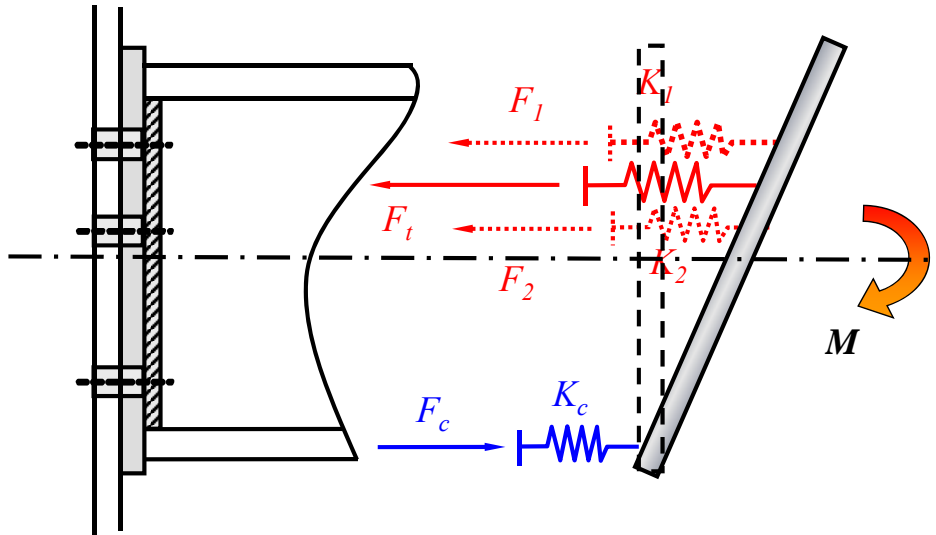

71



The "Component" method with axial force

- Component model deals with load combinations automatically, though M-f curves change due to thrust.

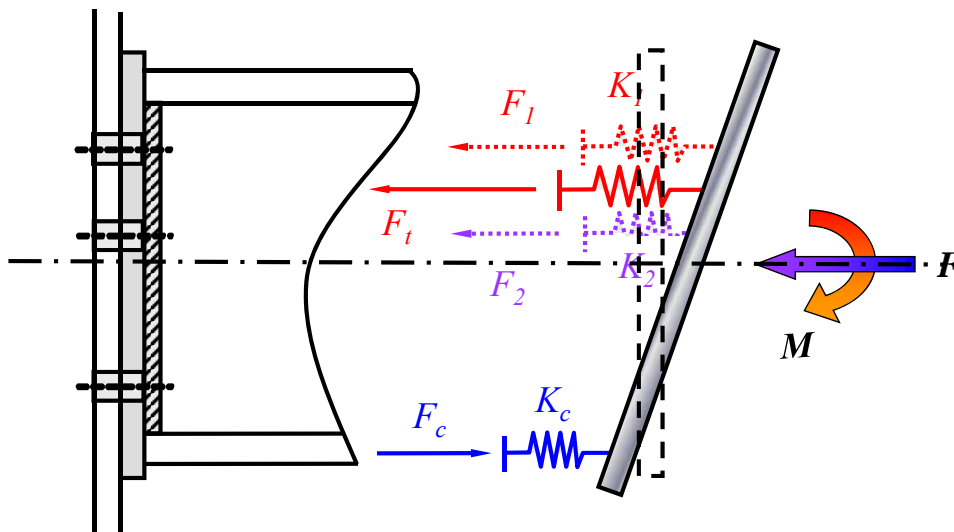

72



Component-Based Connection Element (Block)

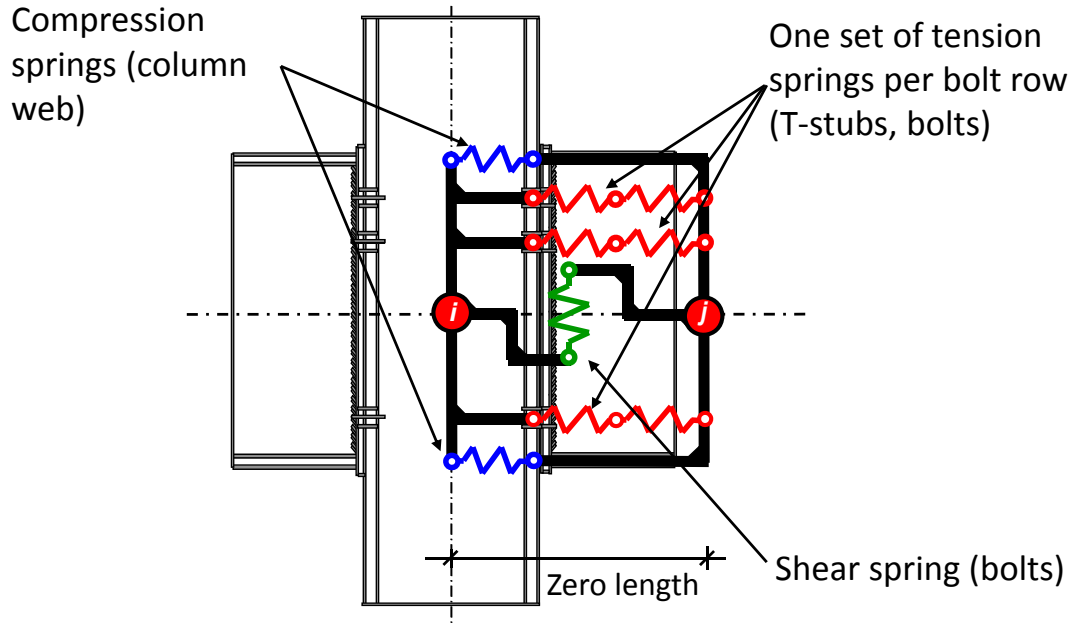

- Beam-end and centre line of column assumed to remain plane
- Tension and compression forces have different lines of action
- Only depends on the geometry and the material of the connection

73



Component-based connection element: beam shear panel

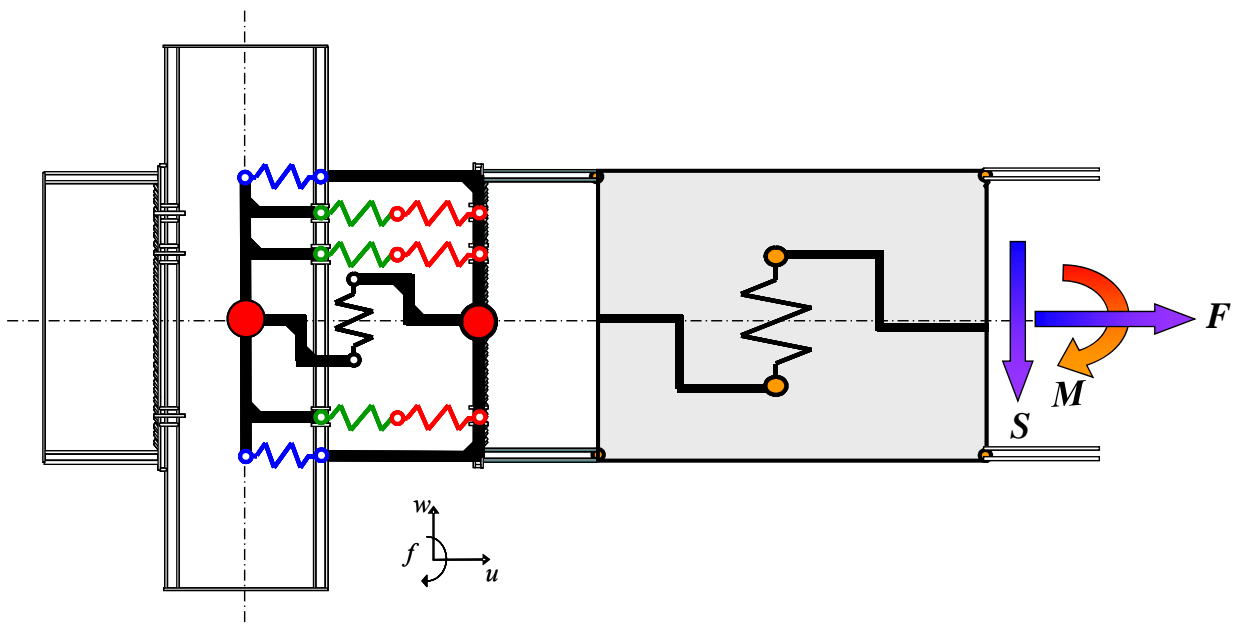

74



Component-based connection element: beam shear panel

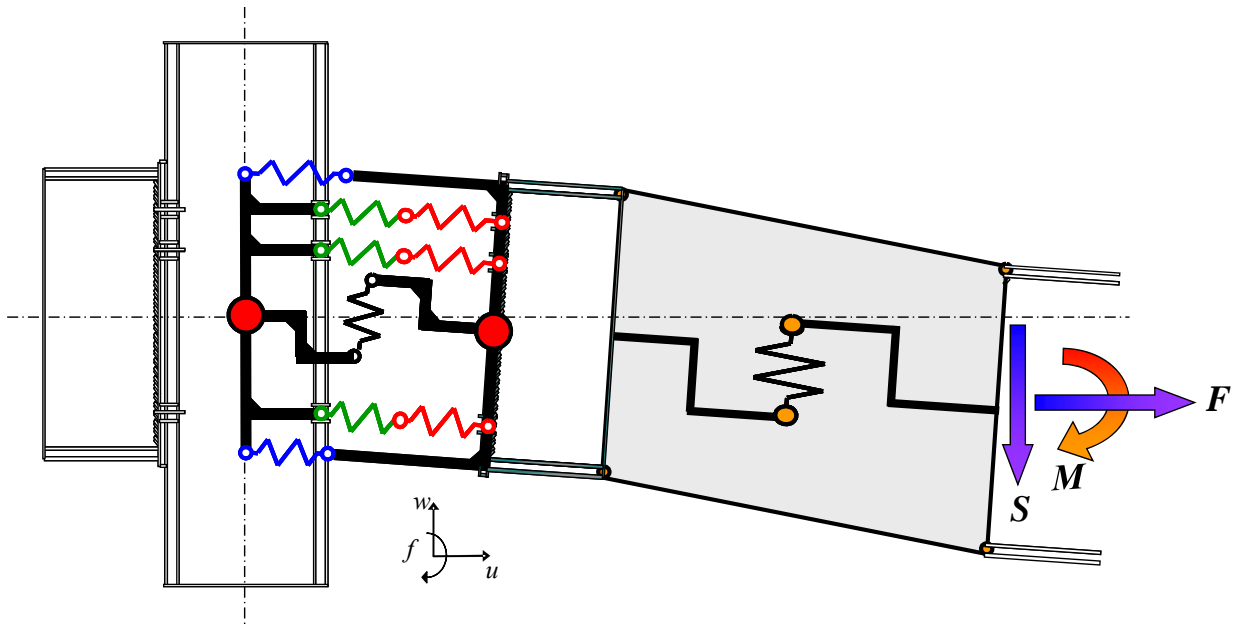

75



Component-based connection element: beam shear panel

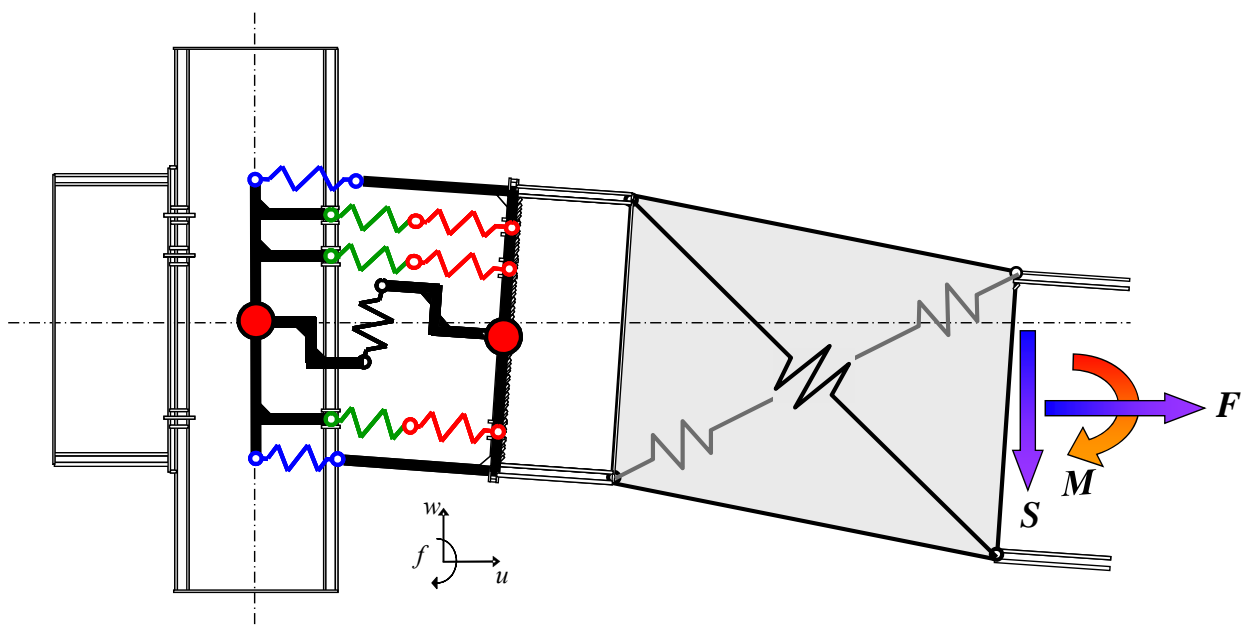



Component-based connection element: including both shear panels

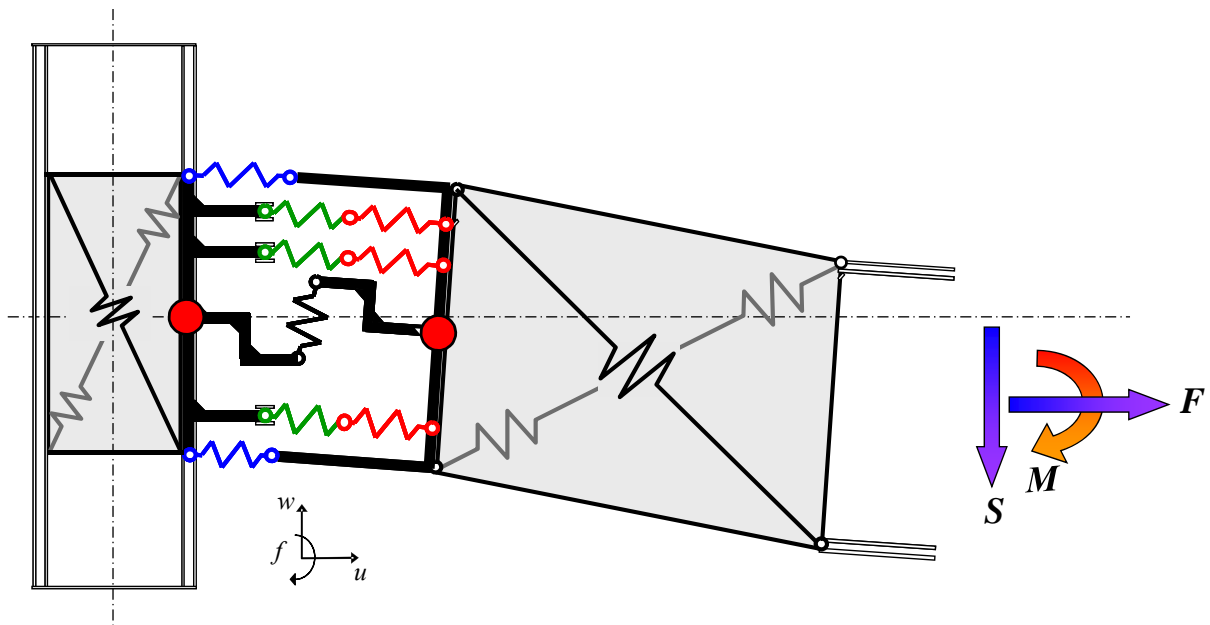

Component-based connection element: centre- line model including shear panels

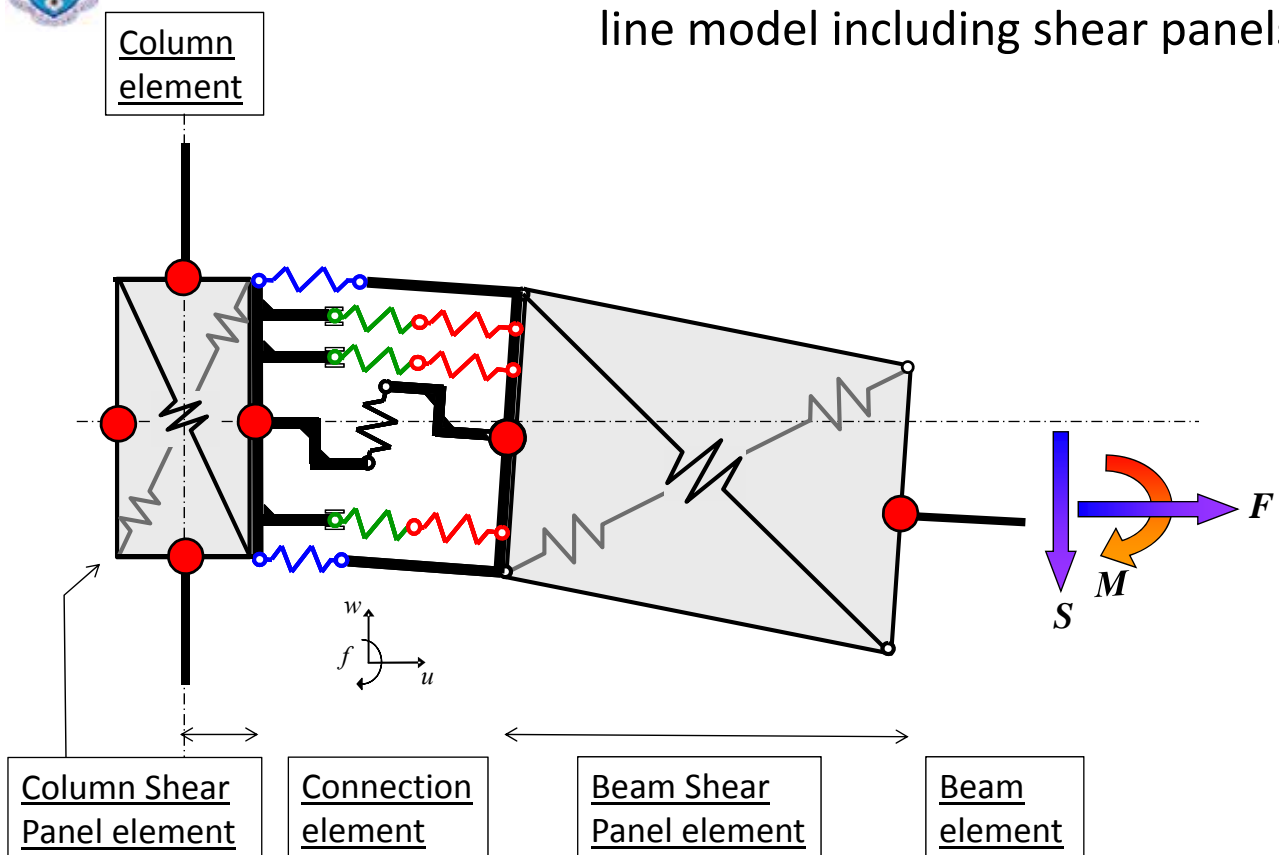



Implementation of joint element in software

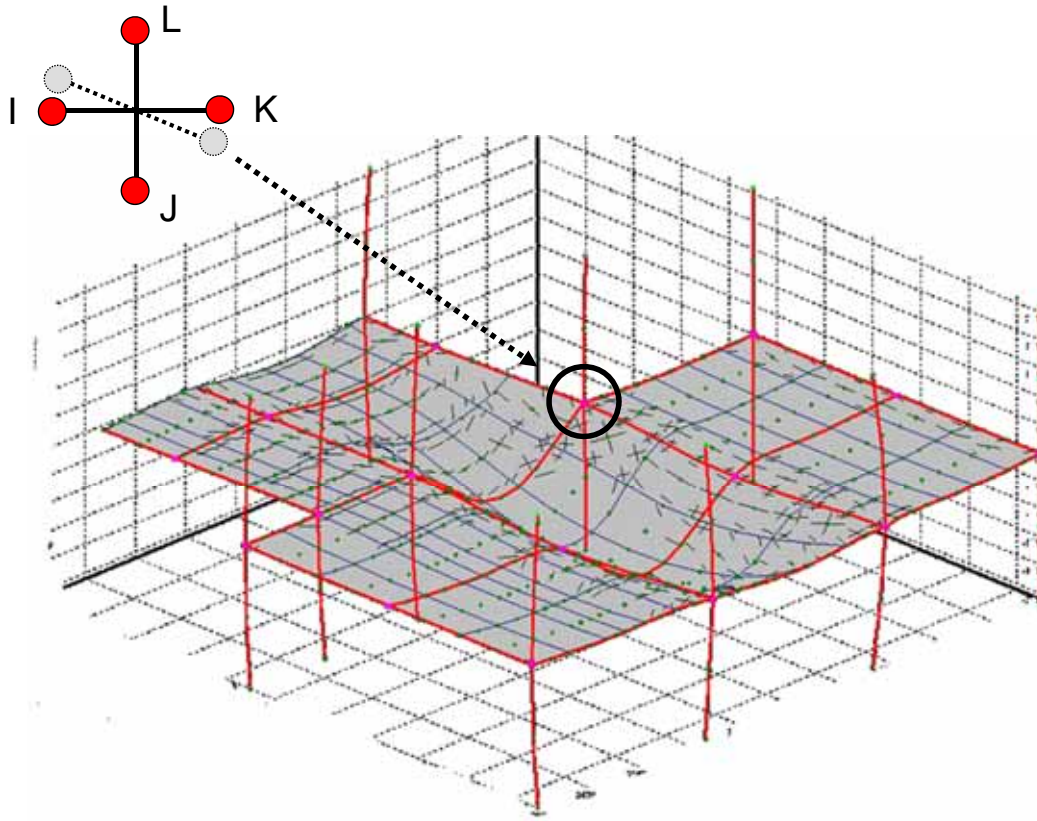

How do connections fail??



Beam section fracture in cooling

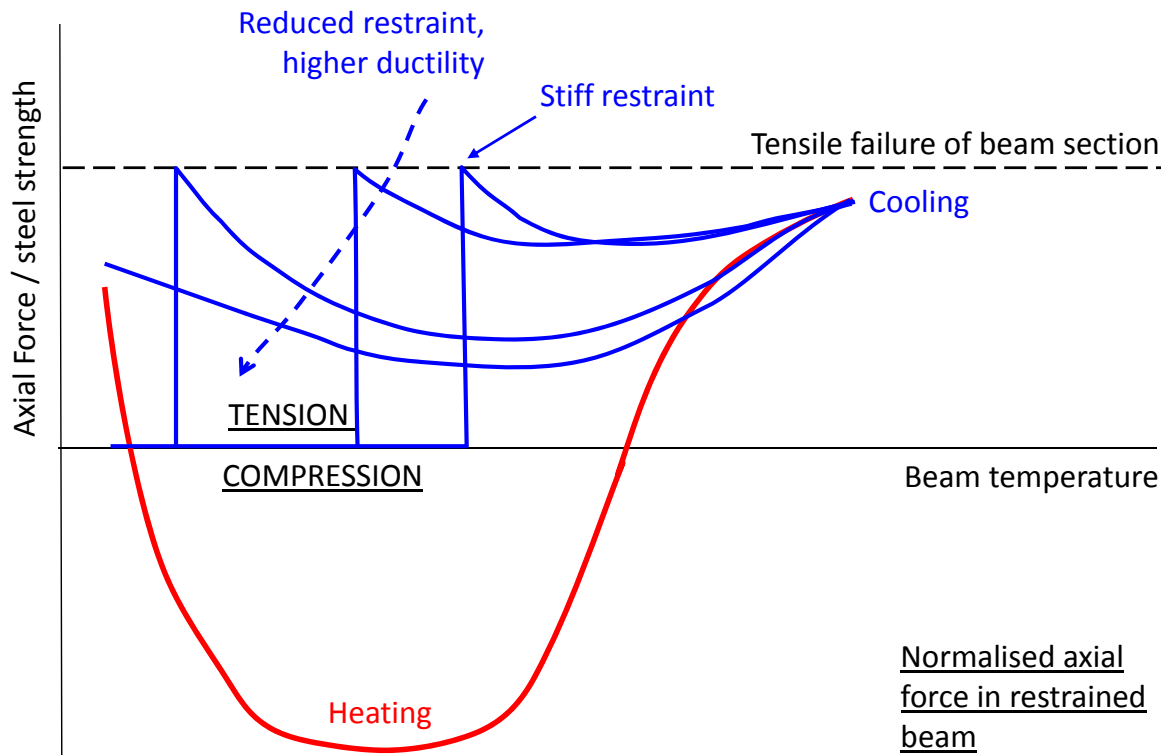

Bolt row failures in heating

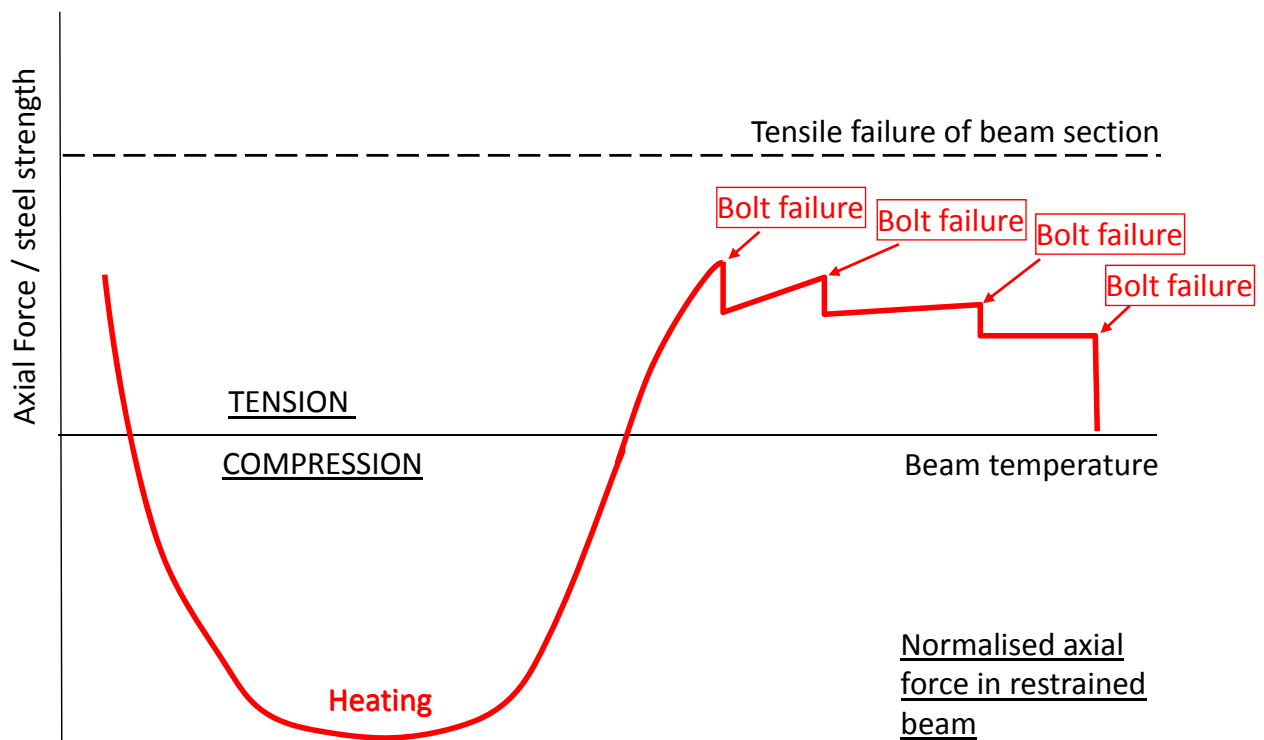



Bolt row failures in cooling

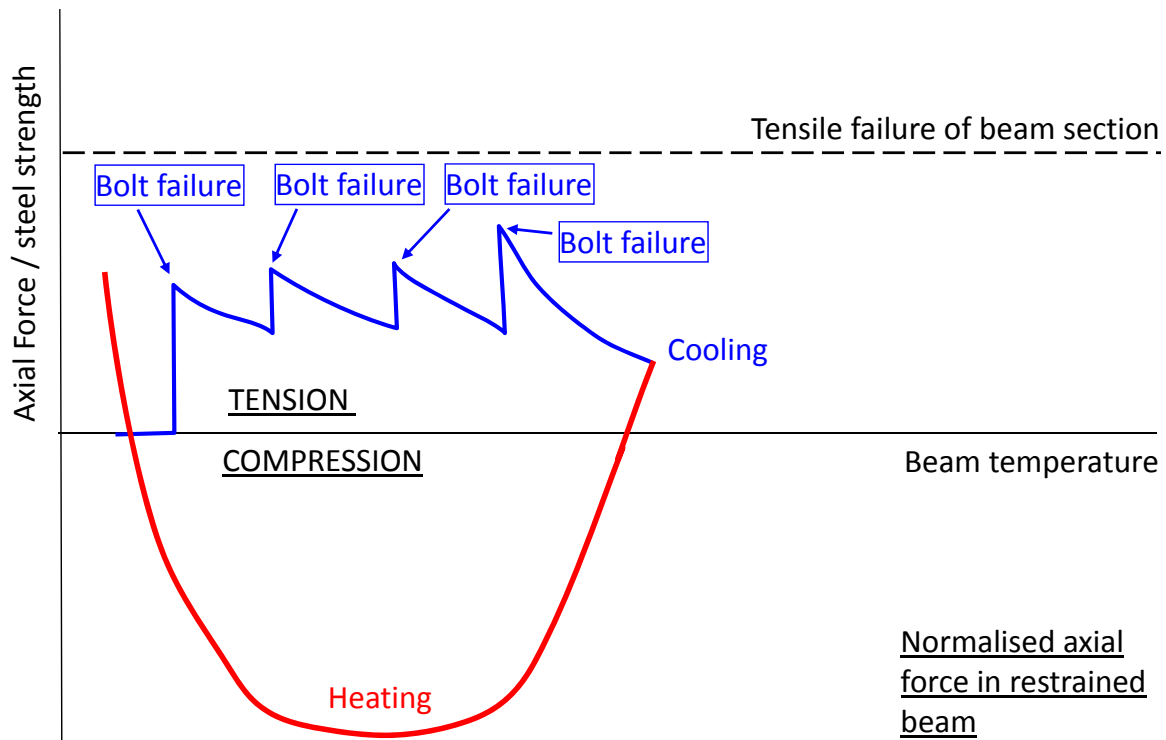

How can we fully model progressive collapse?



Dynamic analysis to identify re-stabilization

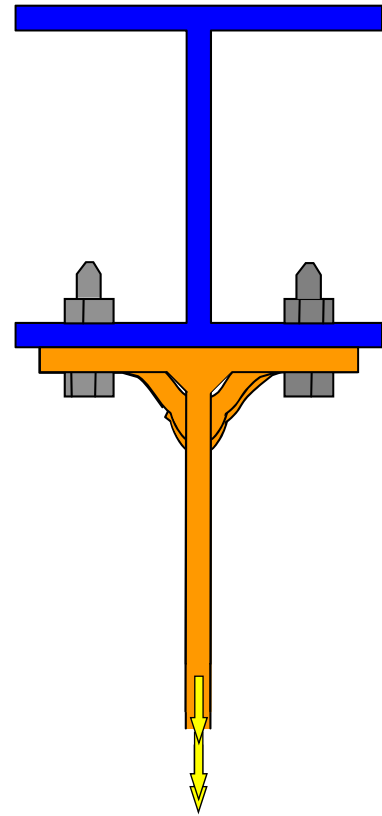
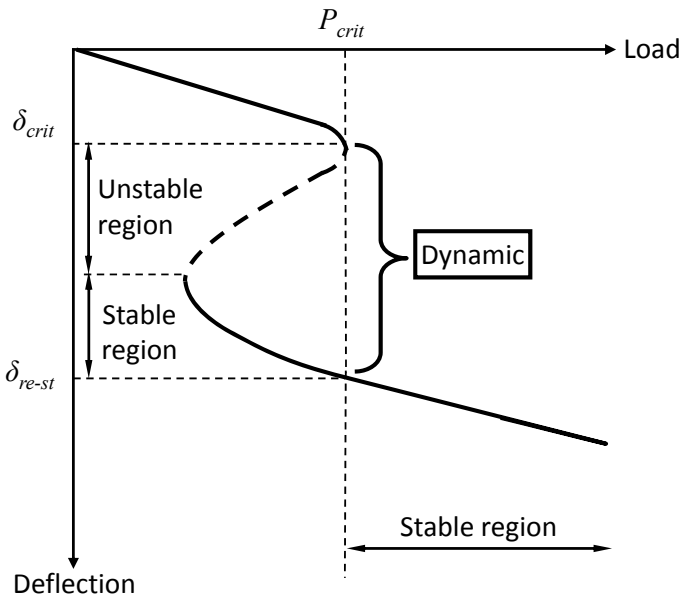

85



Where next?

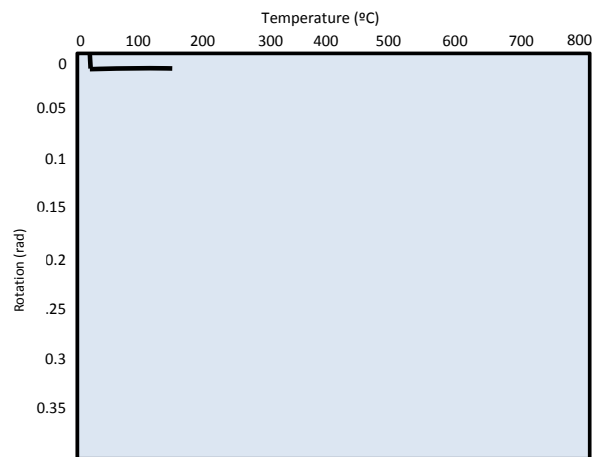
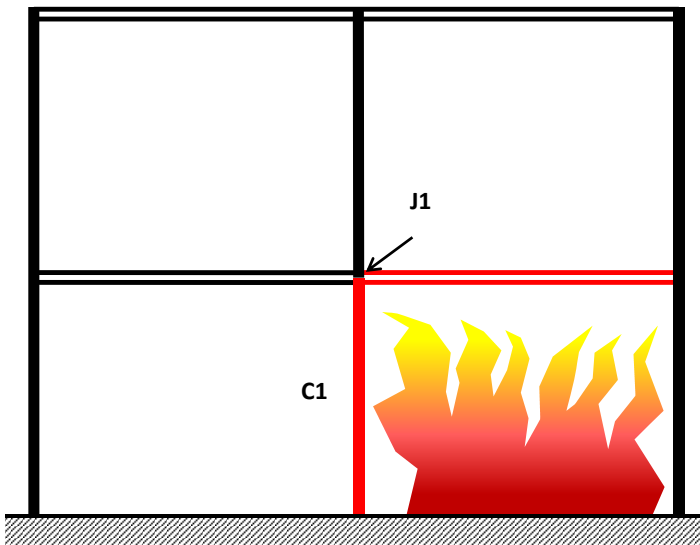



Where next?

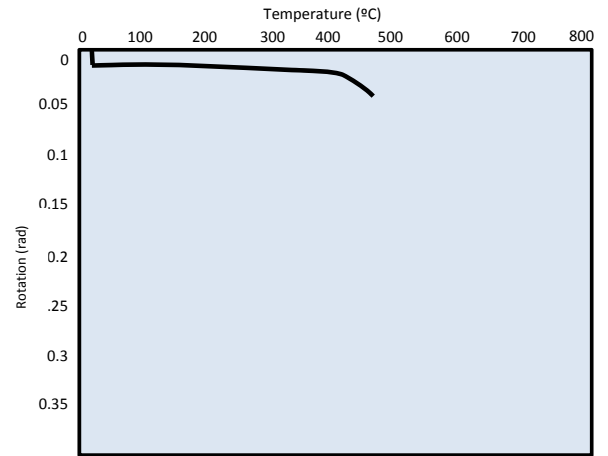
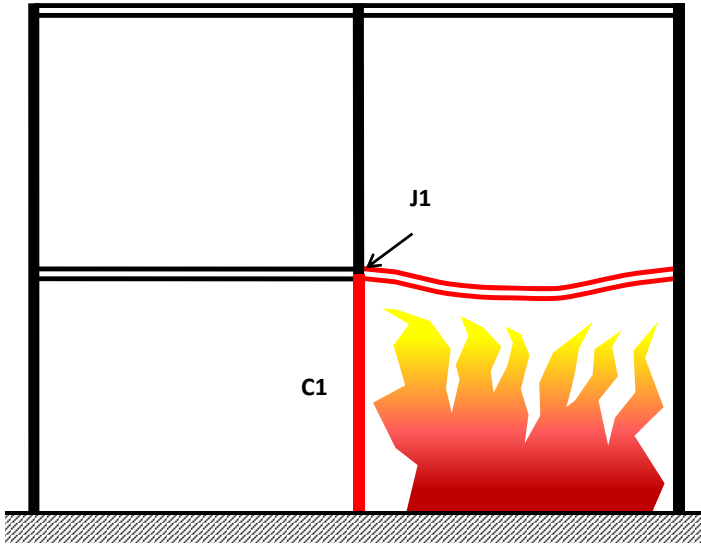

Where next?

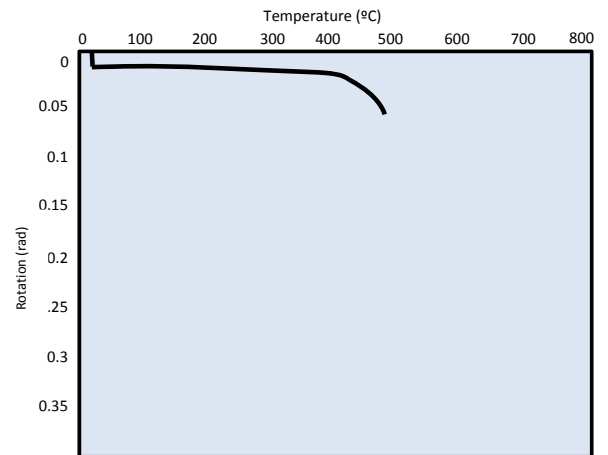
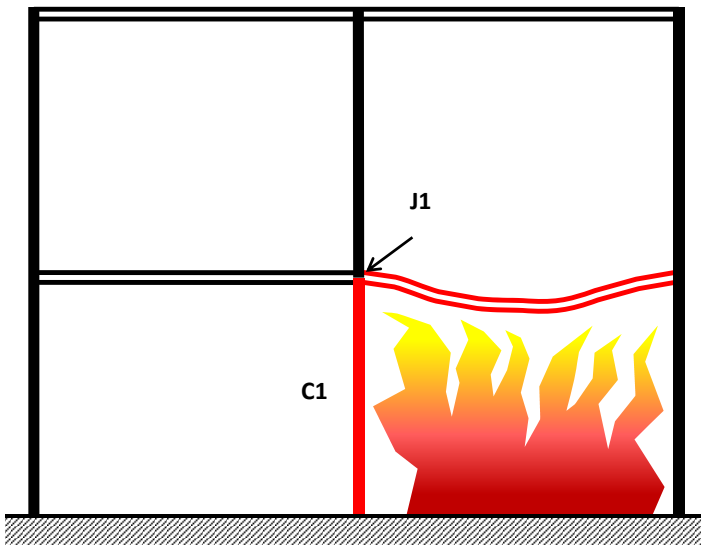



Where next?

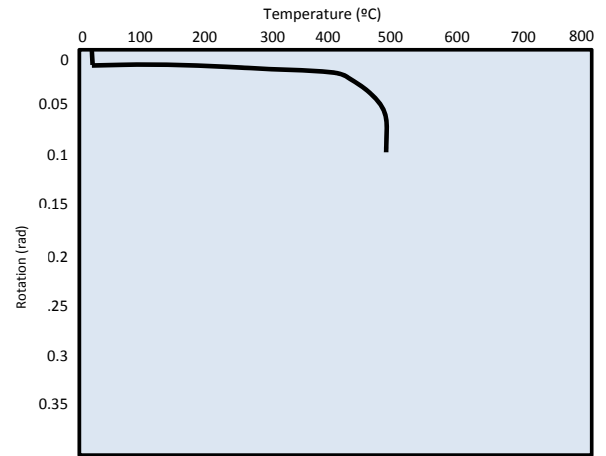
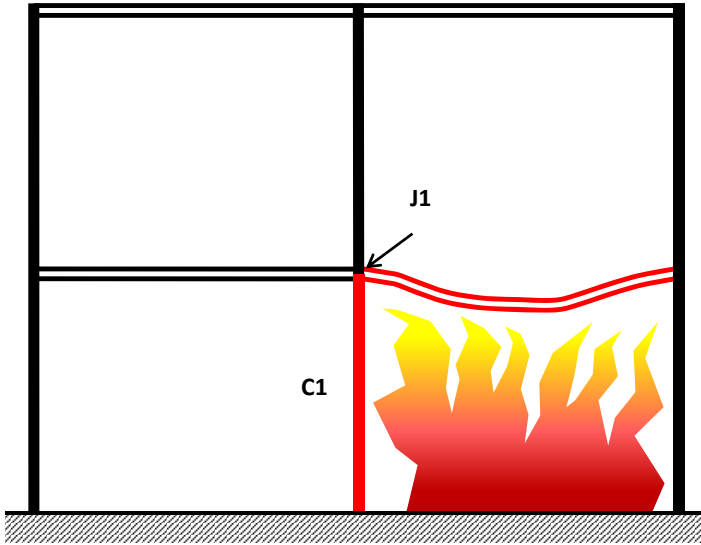

Where next?

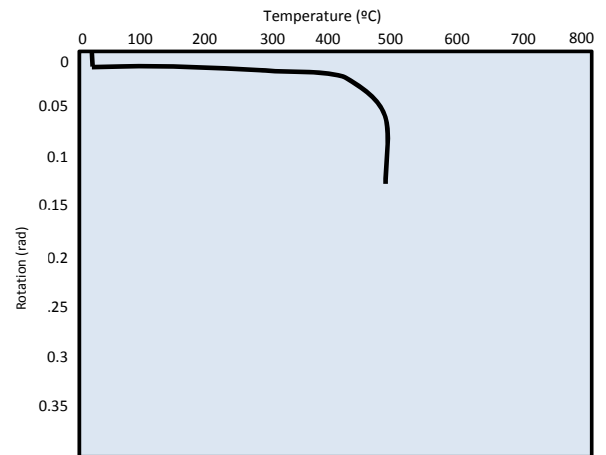
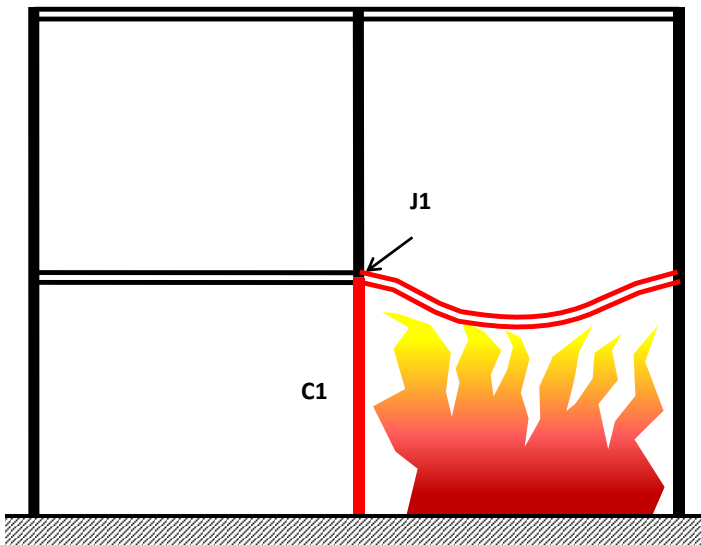



Where next?

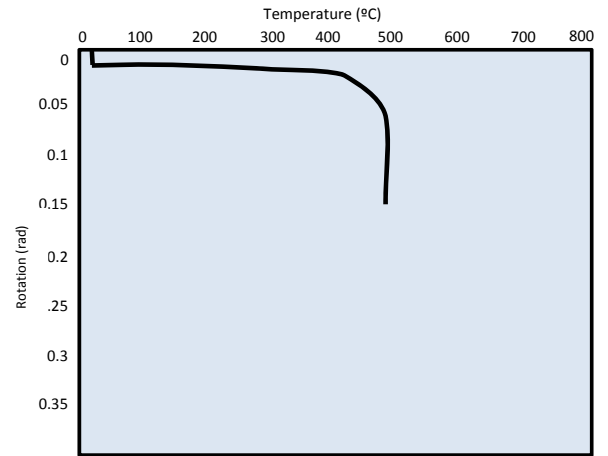
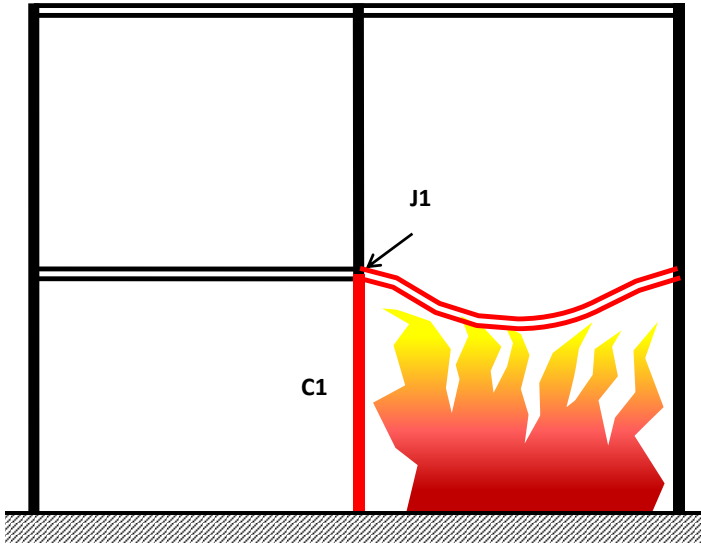

Where next?

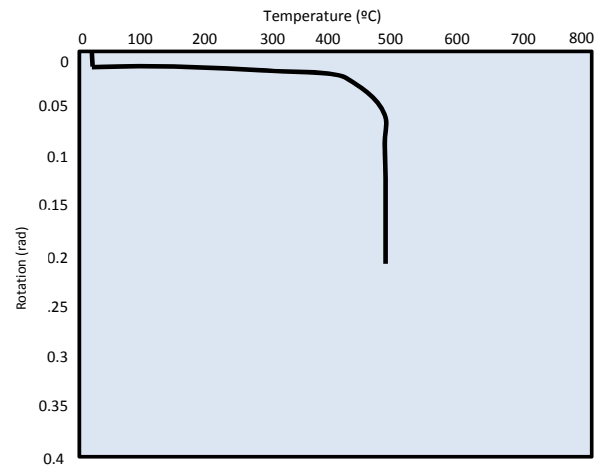
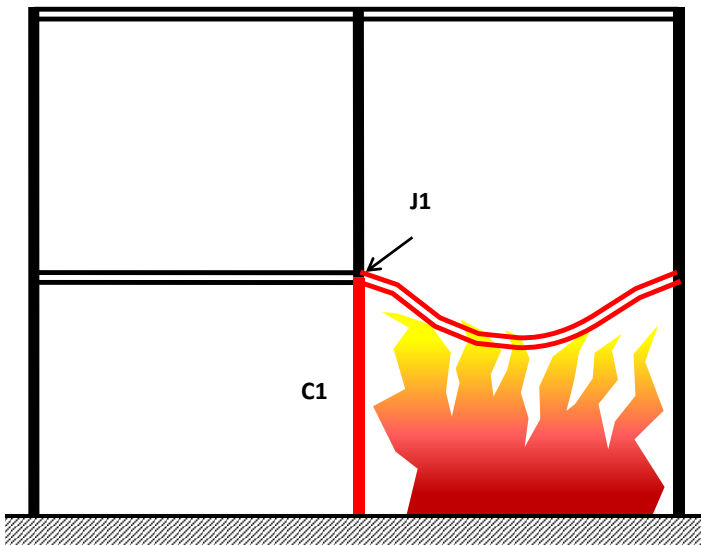



Where next?

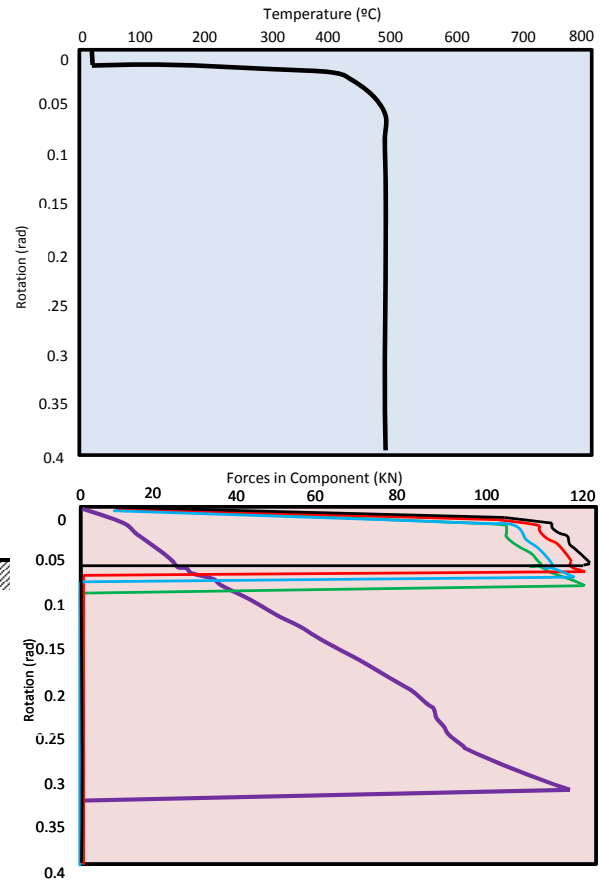
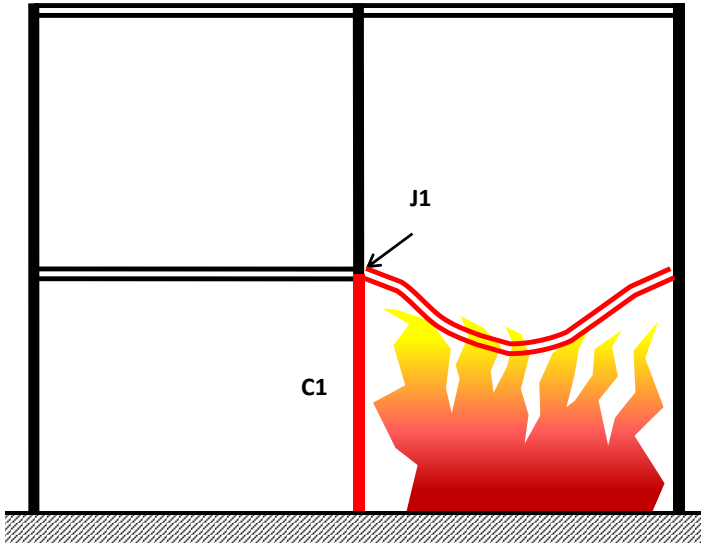

Where next?

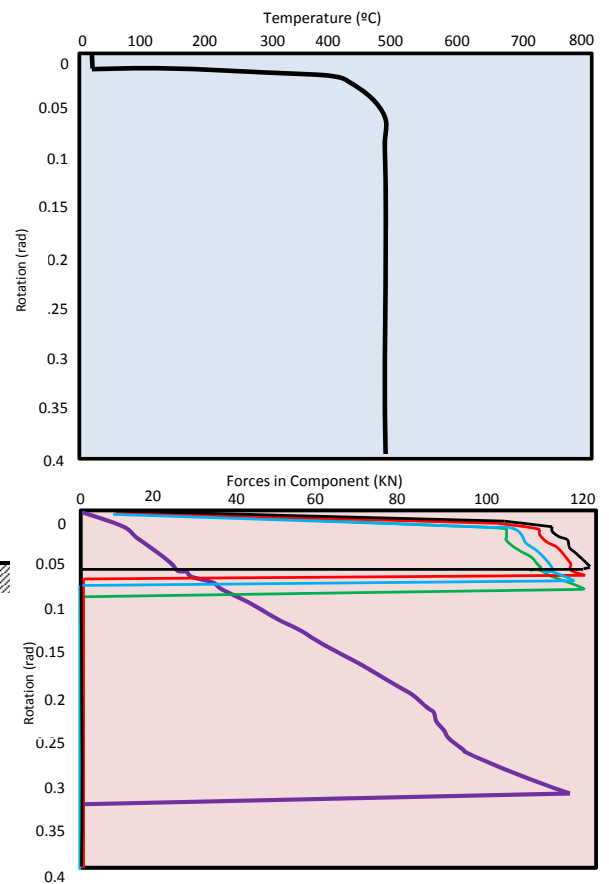
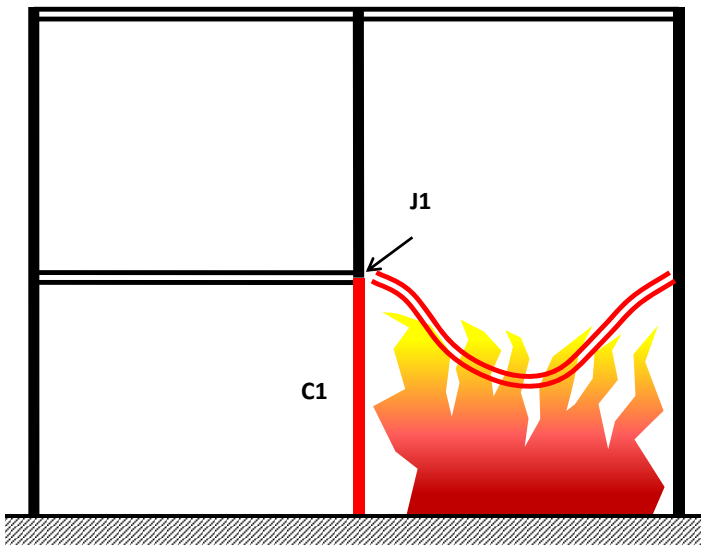



Where next?

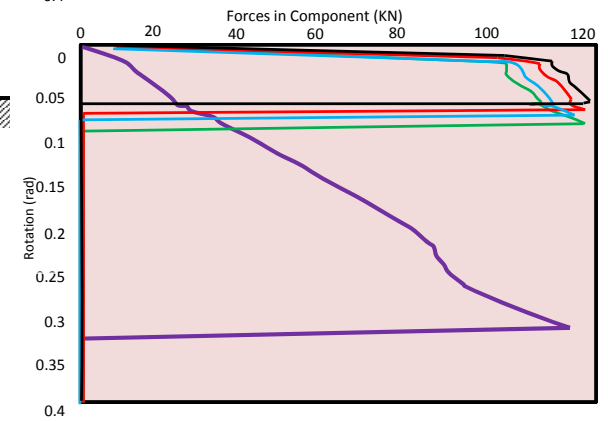
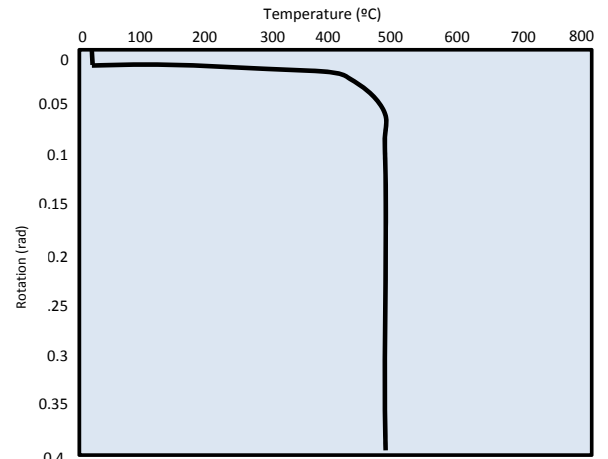
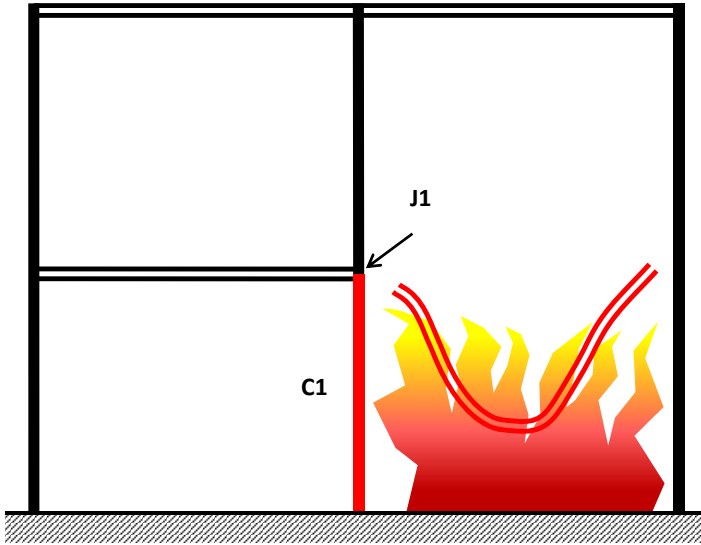

Where next?

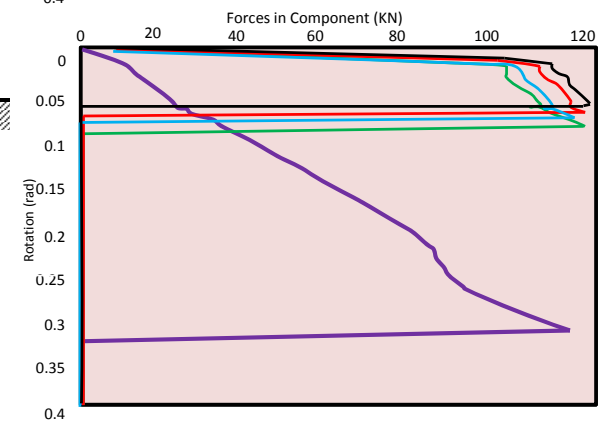
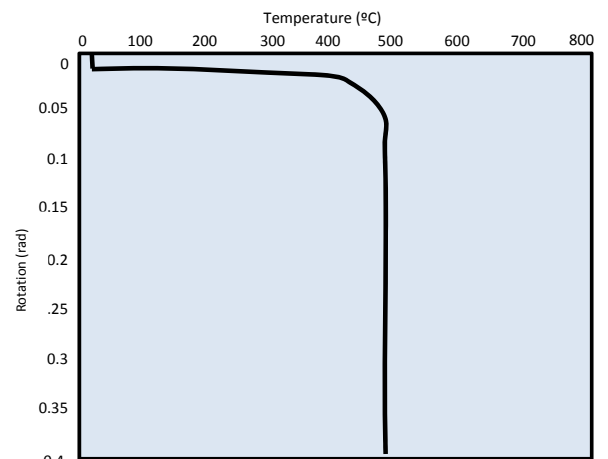
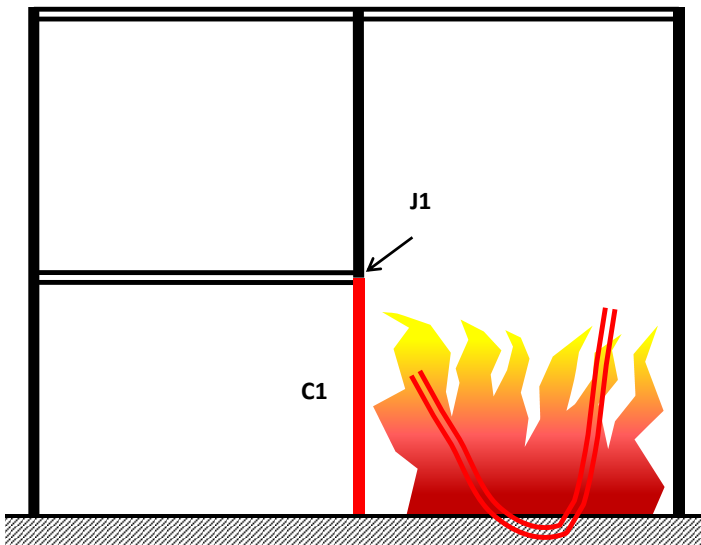



Where next?

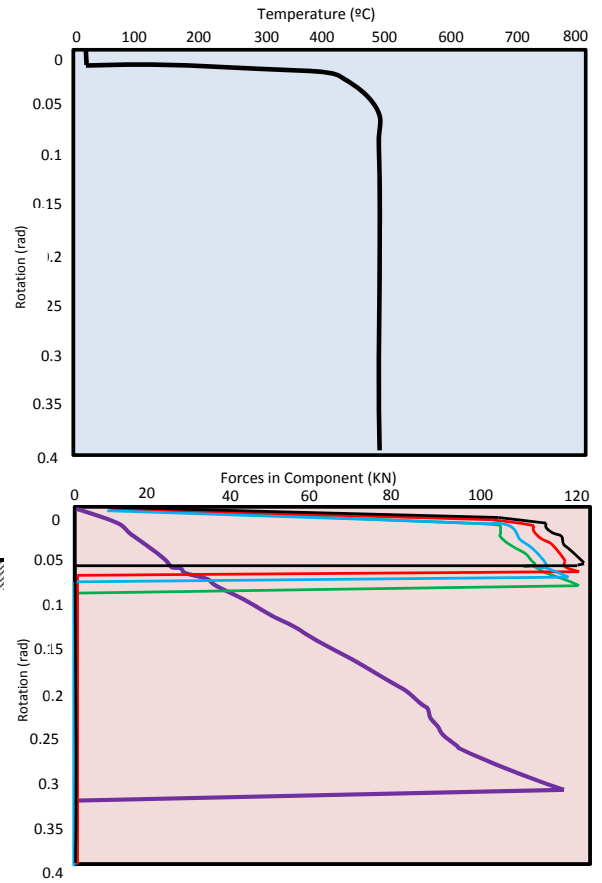
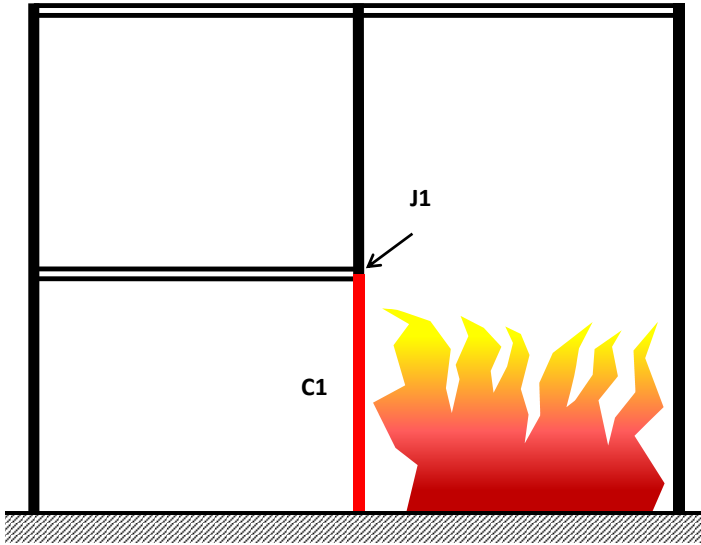

Where next?

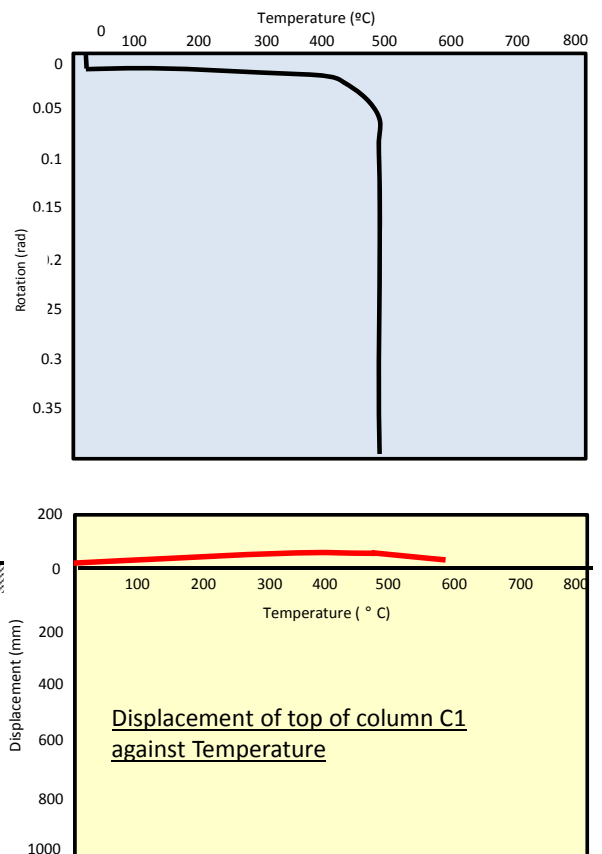
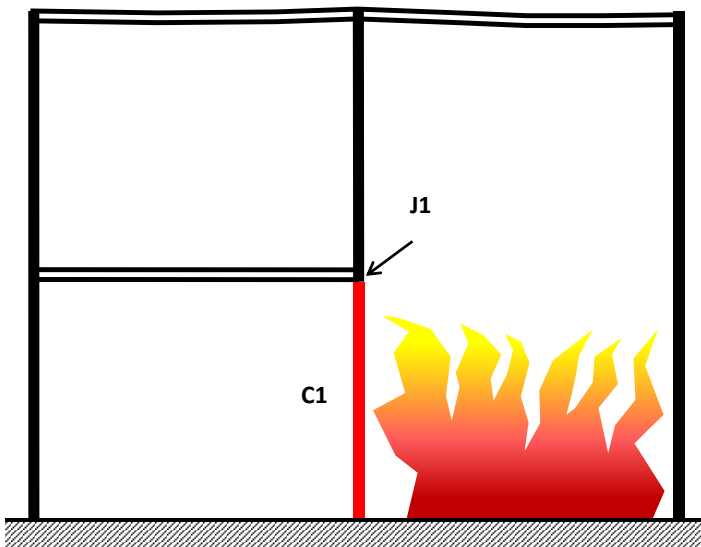

Displacement of top of column C1 against Temperature



Where next?

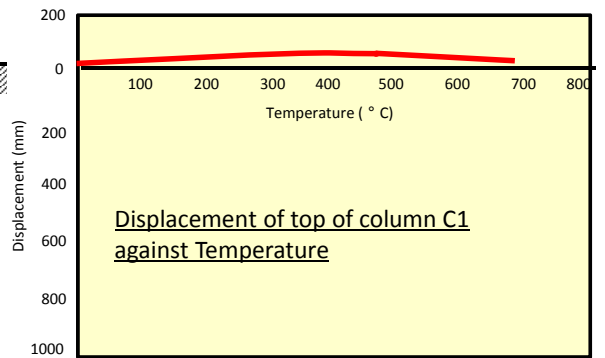
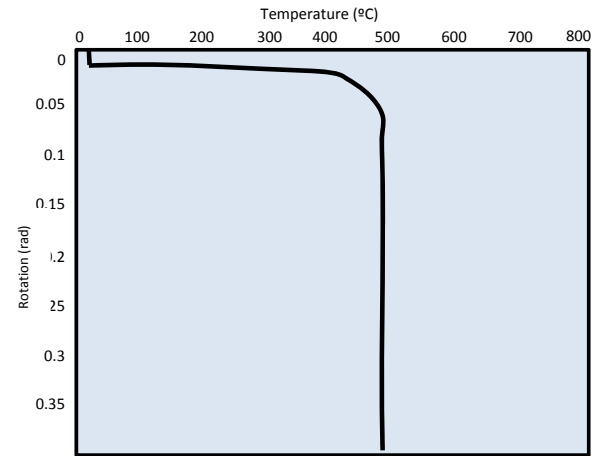
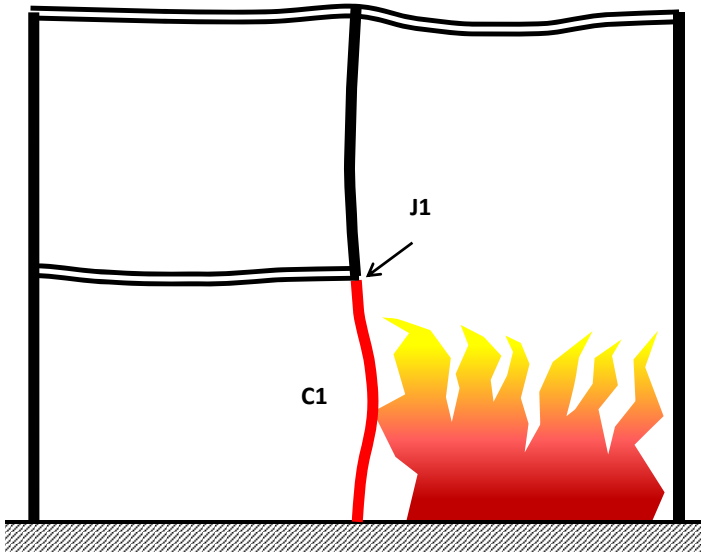

Where next?

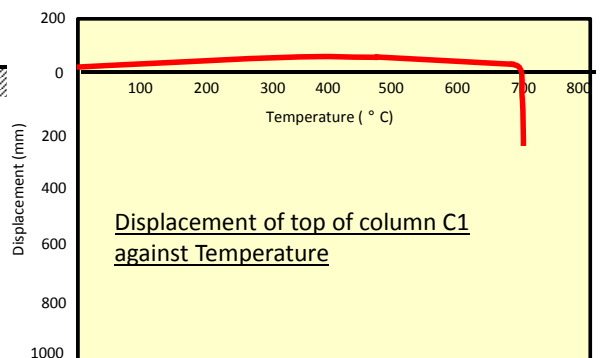
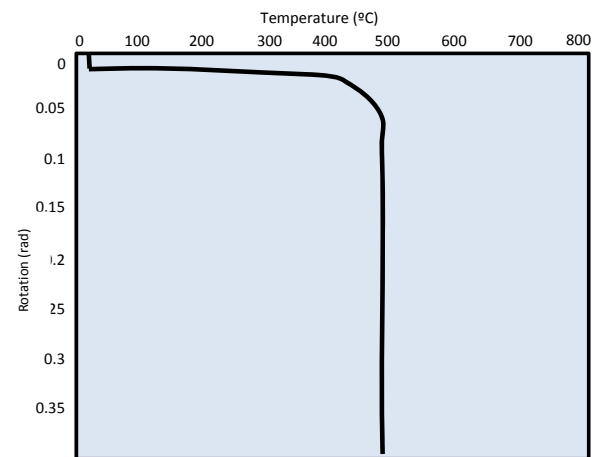
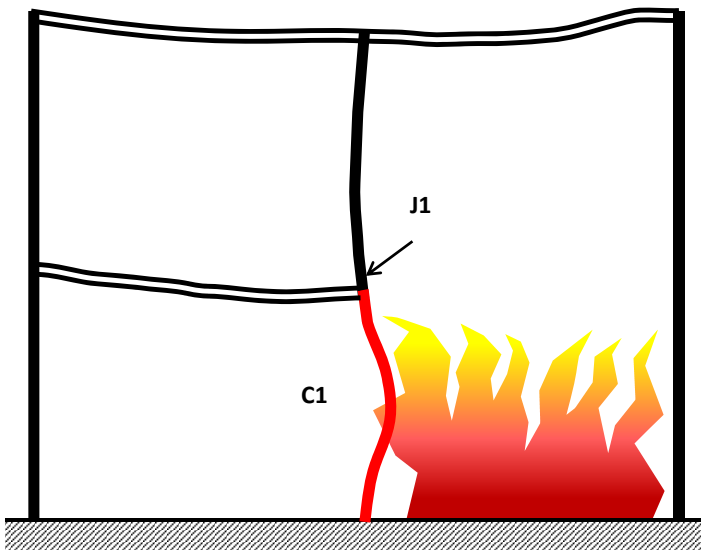



Where next?

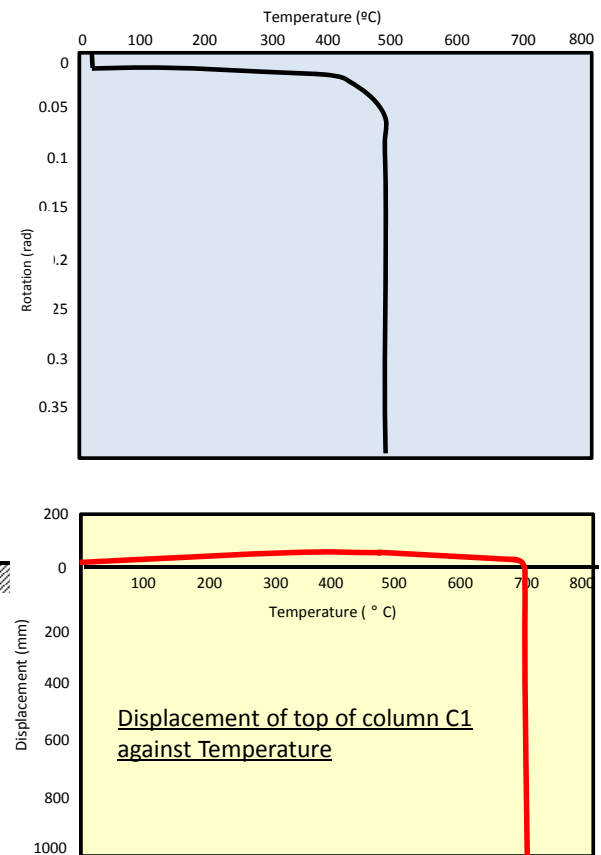
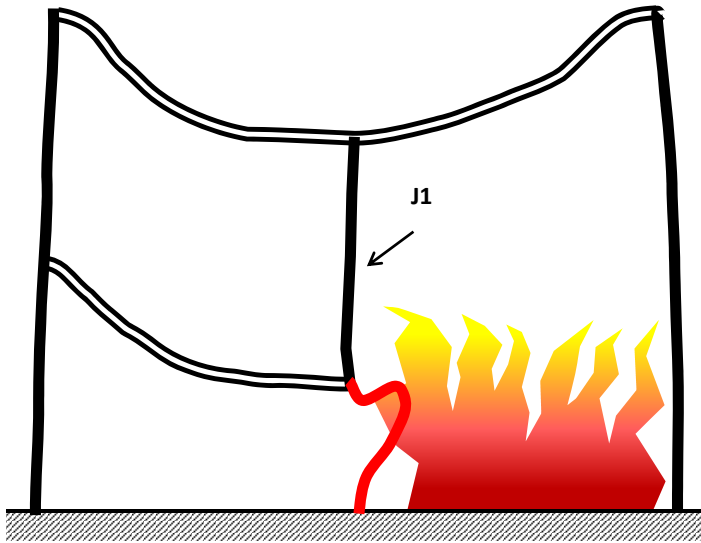

Thoughts ...

Problems

1. Building structure is optimised by designers – and is therefore vulnerable to actions which have not been explicitly considered in design.
2. This can include local fractures and consequential progressive collapse of floors under impact and overload. Finally collapse of columns without support over multiple floors.

Evidence of connection behaviour

1. Cardington shows connection phenomena which can happen.
2. WTC7 shows how design which is OK for normal temperatures can go disastrously wrong in fire.

Predicting behaviour

1. Fire-resistant design based on isolated members simply is not adequate to predict connection fracture in complex structures.
2. The only feasible way for design seems to be global modelling with component-based models.



Will the component-based method work?



Characterizing components for connection element

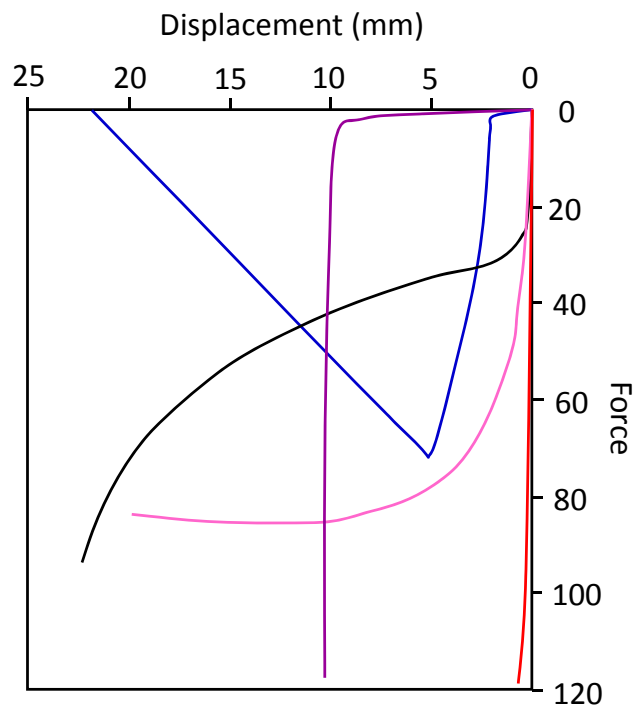
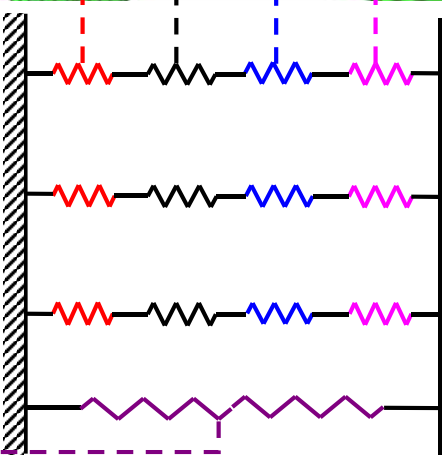
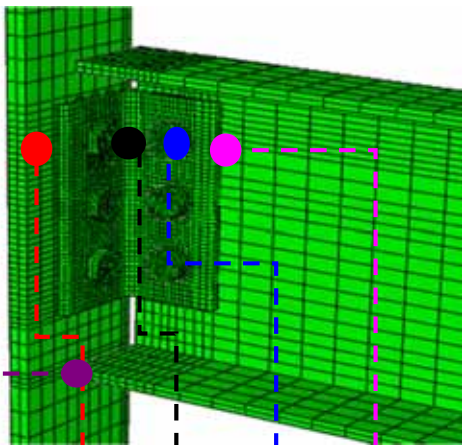



Tests on flush endplate connections

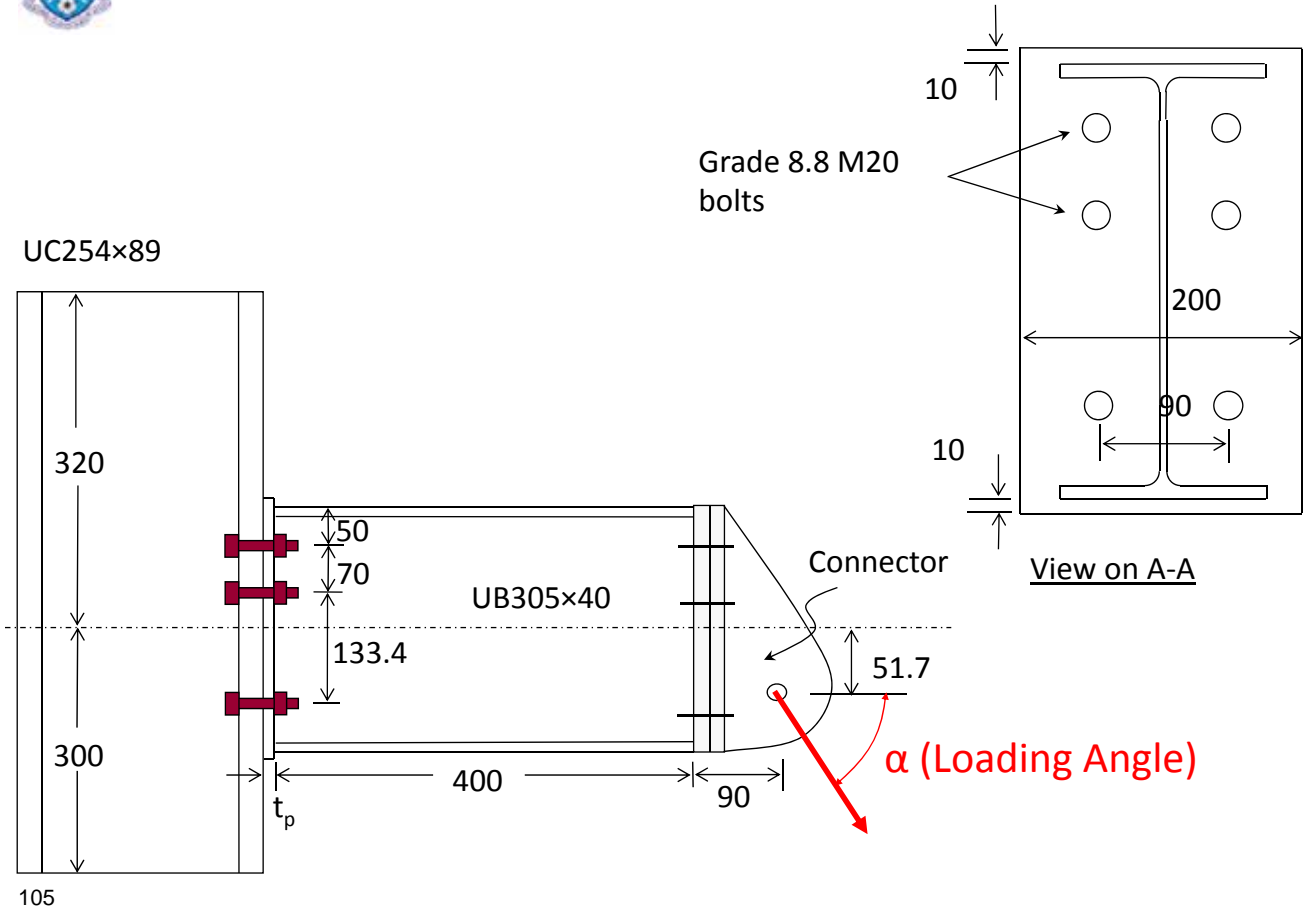

Deformed Shape and Failure Mode

At 20°C





Comparison with web cleat tests : Loading at 35°

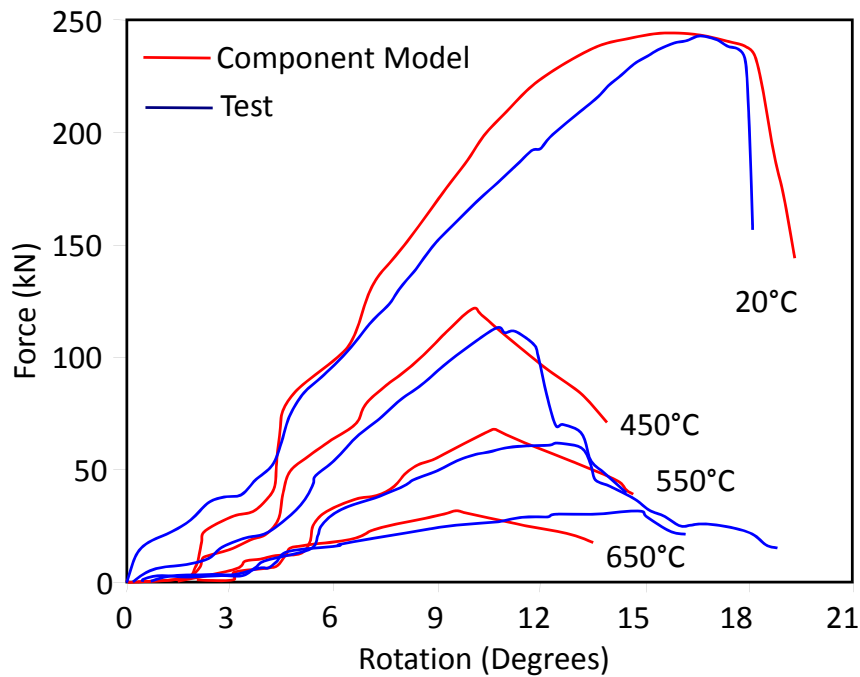

So where are we?

- Component models are:
 - reliable in predicting component fracture,
 - unreliable in predicting stiffness.
- Component-based connection elements provide a practical way of modelling the progressive failure of connections through their components.
- When combined with static-dynamic analysis they allow global structural analysis in fire scenarios which models progressive collapse of whole structures or large sub-structures without excessive numbers of elements or computational effort.
- This could be used in performance-based structural fire engineering design, to optimise the robustness of structures in fire.