



Masonry Buildings: From Past to Present

This presentation was created thanks to the support of FRVŠ project 915/2013 B1d „Tools for teaching design of concrete and masonry structures in English“

Special thanks go to my colleague Dr. Iva Broukalová and whose materials constitute a basis of this presentation (photos with no reference cited were taken from her)

Historical Milestones

- Bricks = the oldest artificial building material
- Air-dried bricks 10 000 – 8 000 BC
- Mould 5 000 BC
- Burning of bricks 3500 BC
- Variance of shapes, layout, surface
- Industrialization of the brick manufacturing – 18th century
- First hollow bricks – 1813





Ancient Civilizations

The oldest houses

- The oldest houses „made of clay“ ≈ reed lodge (swallow nest)
- Brick („bread“) with ornamentation – print of hand

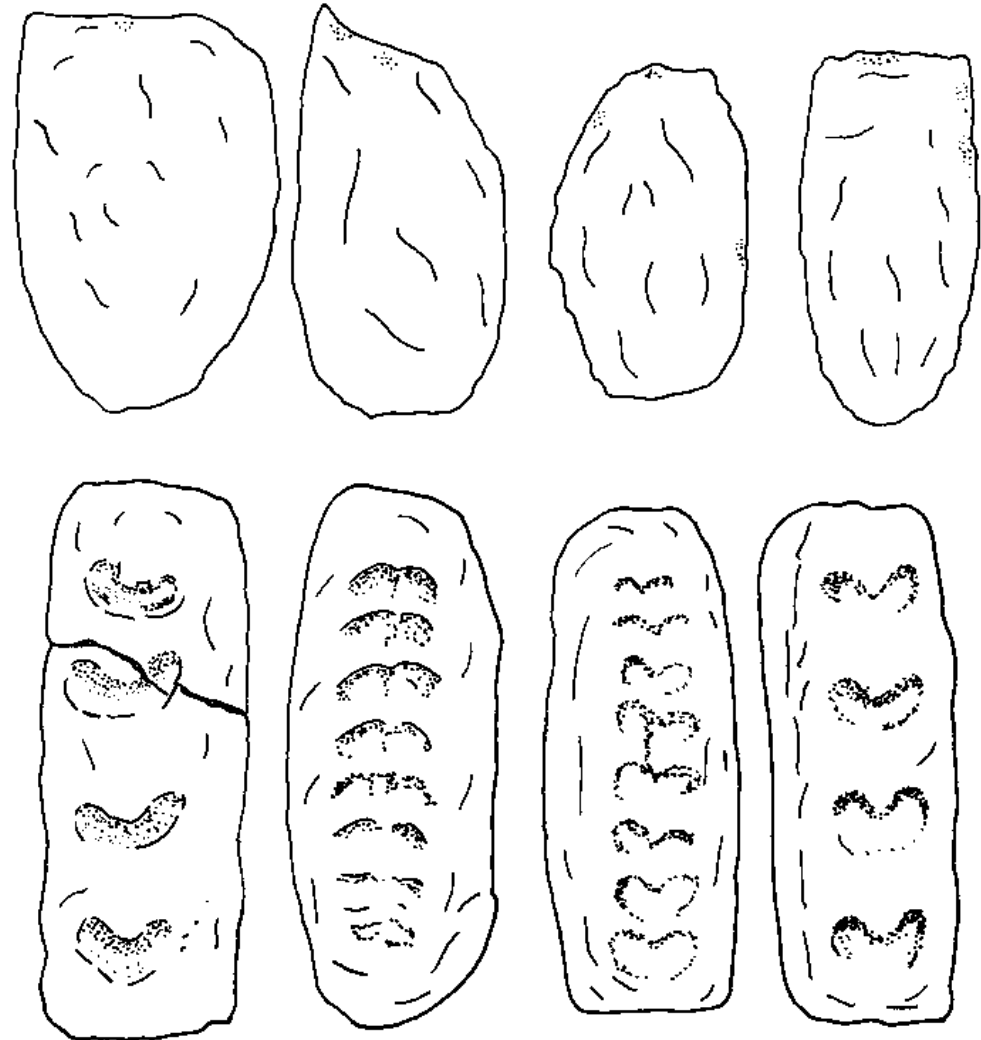

The Walls of Jericho

- The oldest monuments – air-dried bricks from Jericho (near Dead Sea in Israel)
- Flood protection walls of the city with ca 2000 inhabitants



Source: <http://www.empowernetwork.com>



Sumerians and Egyptians

- Mould – 5900-5300 B.C.
- Different shapes and sizes
- Bricks from Nile silt (mud) and straw; this mixture was watered for several days – The straw began to rot; a sticky (adhesive) fabric was released → compactness and strength of bricks
- Air-dried in the sun (as much as 2 years)
- Joint by clay or asphalt

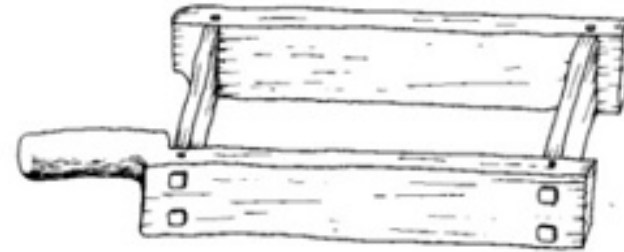

Source: <http://www.bibleistrue.com>



Fire Bricks (Burnt Bricks)

- Mesopotamia – Uruk 3100-2900 BC
- Costs 30times more
- Ziggurats – inner parts air-dried bricks, outside (cladding) burnt bricks (10 %)
- Mortar clay or natural asphalt
- Ornamentation – embossment, coloured glazing



Ziggurat Choga Zanbil

- Size 67 m
- Brick size 350x150x100 mm
- Basic shapes of bricks, detail of brick bond >>>



concrete.fsv.cvut.cz/~bily



Ishtar Gate

- Babylon, 600 BC (Nabukadnezar II)
- Mud brick masonry with glazed skin
- Glazed brick relief mosaic decorations

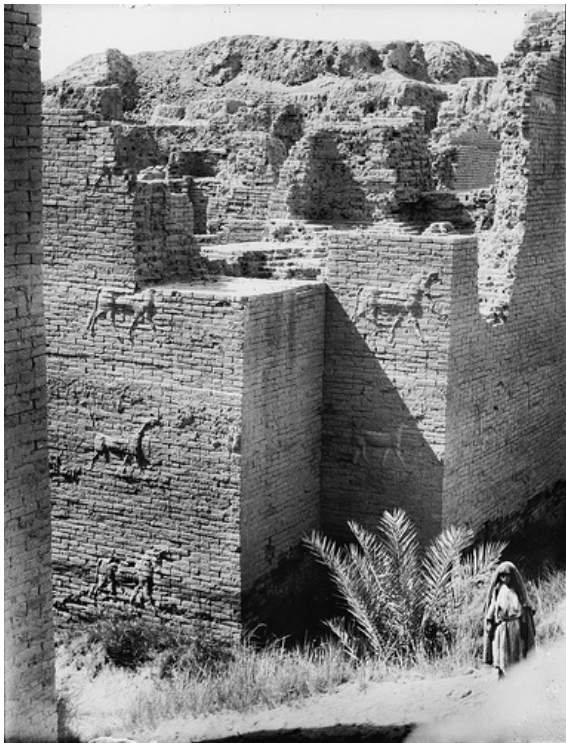



Ancient Rome

Overview

- Vitruvius – Ten books about architecture
- Dwelling buildings – initially half-timbered with adobe brick
- Public buildings – Rome concrete with masonry cladding from tuff
- Air-dried bricks
- Burnt bricks – during rule of emperors (beginning of the 1st century).
- Guilds – large-scale production, typisation (shaped pieces), normalisation, sizes, labelling
- Burning in kilns with separated fire-place
- Masonry buildings, columns and pillars, arch, floor
- Whole masonry quarters, multi-storey houses



Overview

- Vitruvius – Ten books about architecture
- Dwelling buildings – initially half-timbered with adobe brick
- Public buildings – Rome concrete with masonry cladding from tuff
- Air-dried bricks
- Burnt bricks – during rule of emperors (beginning of the 1st century).
- Guilds – large-scale production, typisation (shaped pieces), normalisation, sizes, labelling
- Burning in kilns with separated fire-place
- Masonry buildings, columns and pillars, arch, floor
- Whole masonry quarters, multi-storey houses



Roman Bricks

- 1 besalis, 2 pedalis, 3 sequipedalis, 4 bipedalis, 5 lydion, 6 imbrese, 7 tegula; labels; kiln

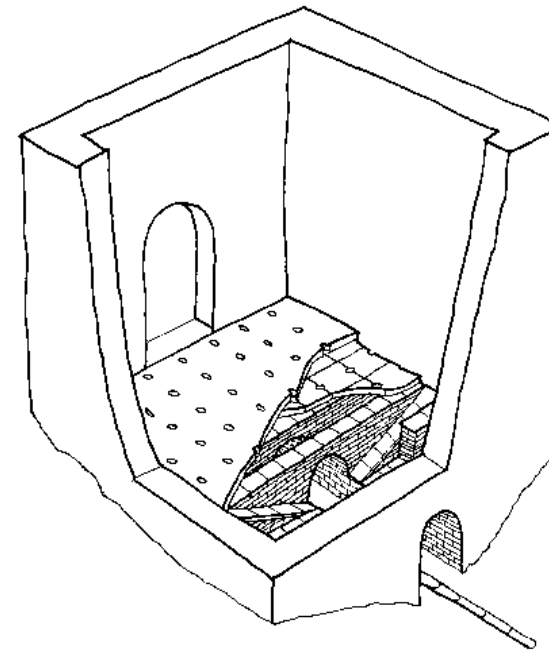
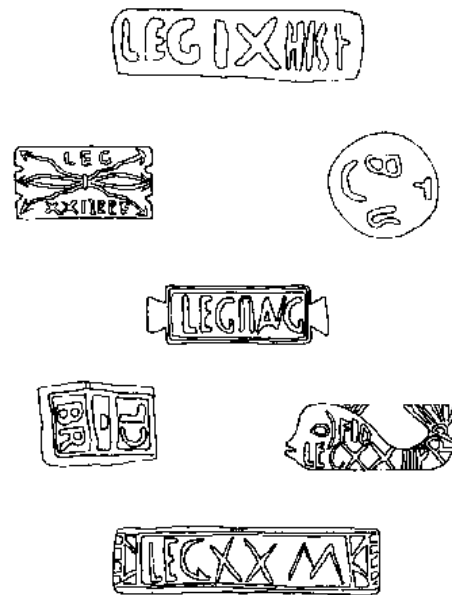
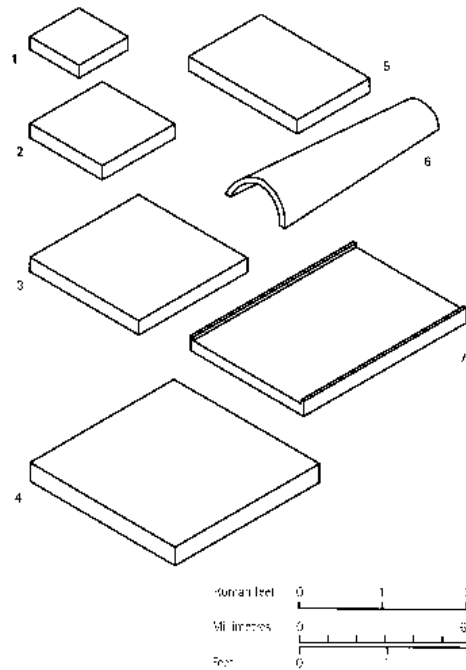

Pantheon

- Hadrian (118-128)
- Inner diameter 43 m
- Height 50 m
- Dome (cupola) from the Rome concrete, in the lower part – cylinder (thickness of wall 6,05 m)
- Brick arches in the cylindrical part



Pantheon



Coliseum (Colosseum)

- Rome 80 AC
- The greatest amphitheatre of the Roman Empire held up to 70.000 people
- Bearing masonry, cut stone
- Tiers of arches and half-columns of Doric, Ionic, and Corinthian orders



Coliseum (Colosseum)

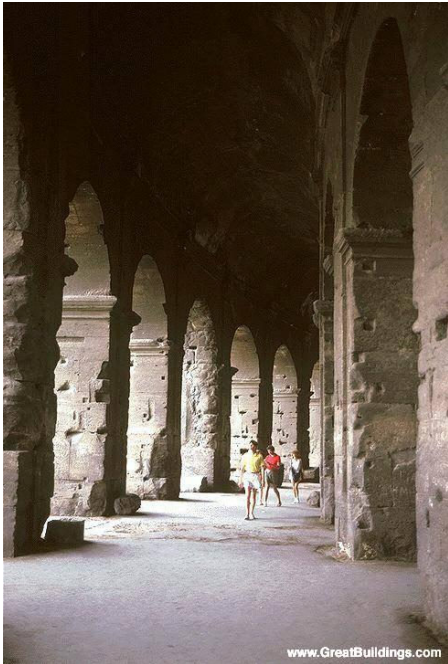



Byzantine Empire

Overview

- Constantinople – centre since 330 AD
- Central management – rules, regulations (qualification, guarantee for 10years, forbidden to work on more sites at the same time)
- Rubble masonry with brick face
- Flat bricks, wide joints, sometimes coloured



concrete.fsv.cvut.cz/~bily



www.shutterstock.com · 36505165



St. Sophia Church

- Justinian 532 AD



Churches of Christ Pentepoptese and St. Irene

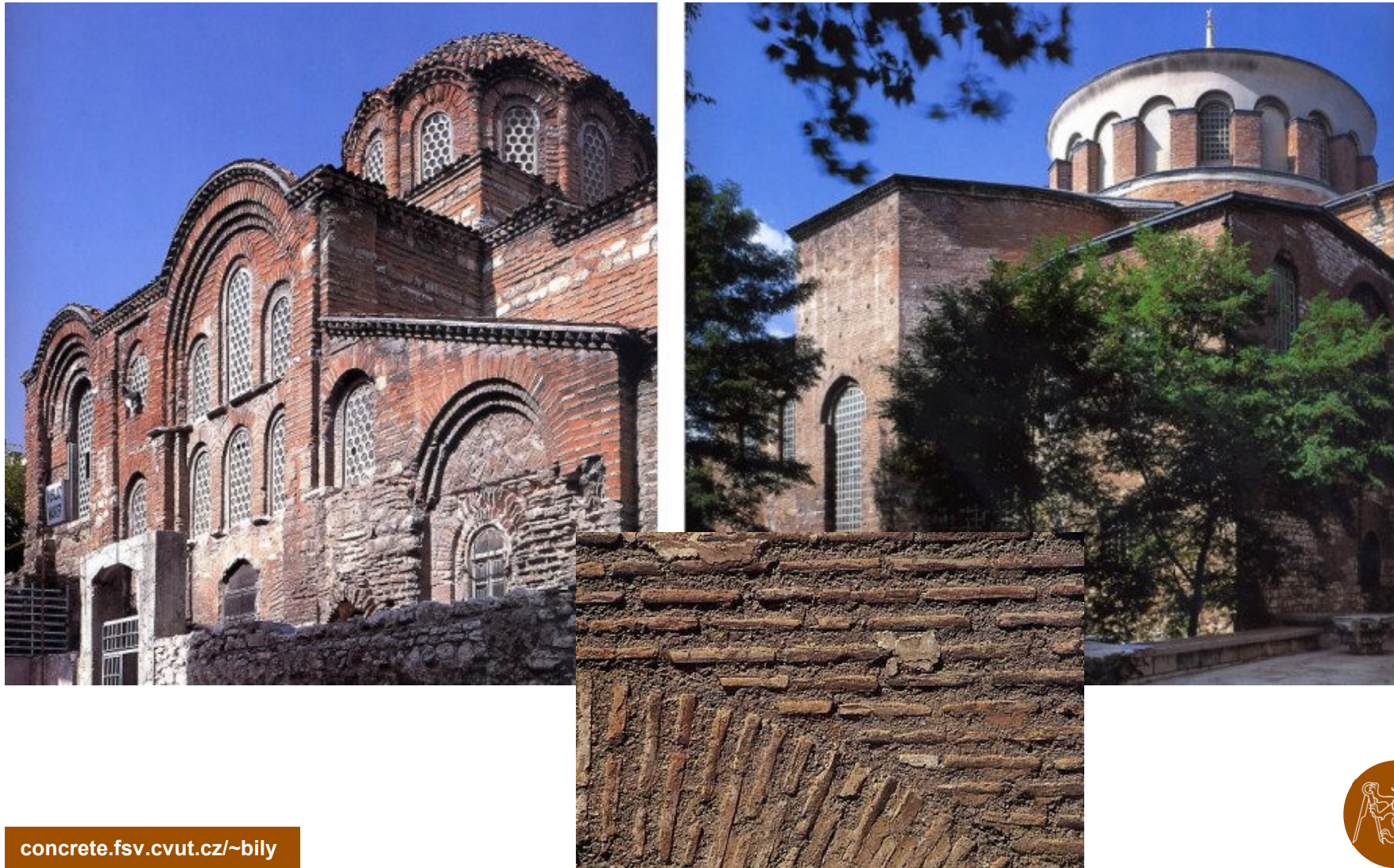

Central Asia

- Mausoleum Samani, Buchara 900 AD, size 10,8 m
- Four-square bricks thickness 40 mm, joints 10 mm
- Ornamentation: pattern by bond
- Bricks formed also after burning

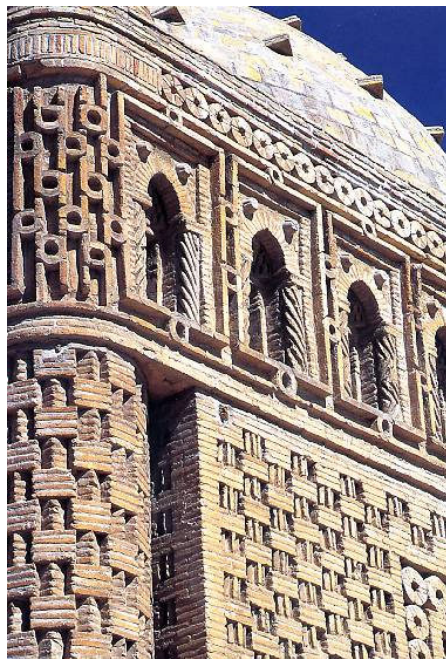
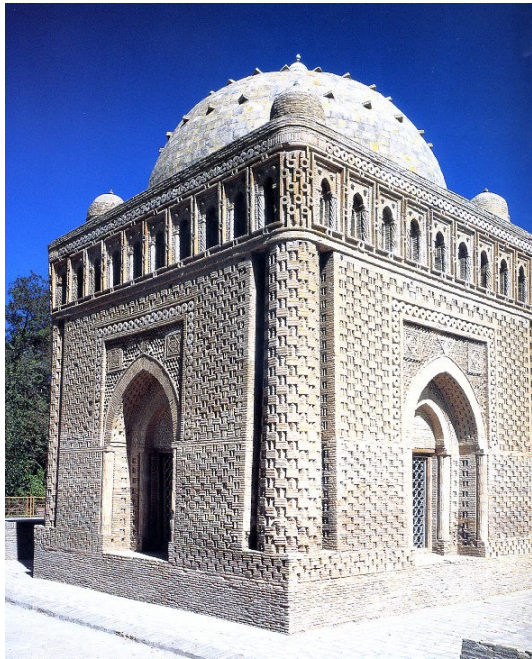



Middle Ages

(1000 – 1450 AD)

Barma

- Town Pagan
- Buddhist basis of civilization, lasted 300 years until 1287
- 2000 sacred buildings rest until today (from 5000)
- Stupas and churches – arched space

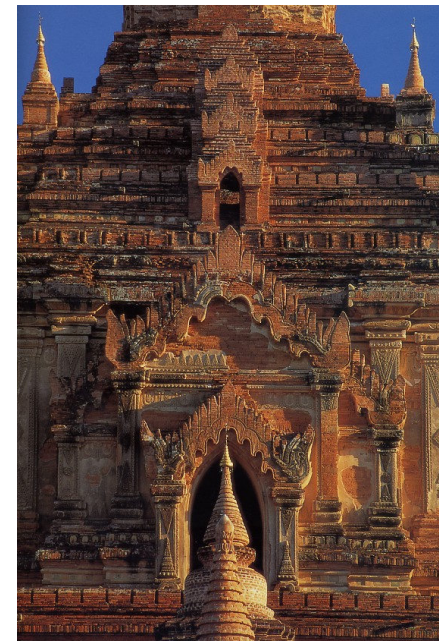

Barma – Town Pagan



Pagoda Long Hua (Shanghai, 977)

- Built on the previous stupa
- Staircase inside
- Watchtower, light-house, observatory
- Brick with high strength, unique bond



Minaret of the Al-Mutawakkil Mosque

- Sammara (Iraq)
- 9th century
- 52 meters high
- The eastern provinces of the Islamic empire always had their own architectural traditions and differ from the Arabian architecture

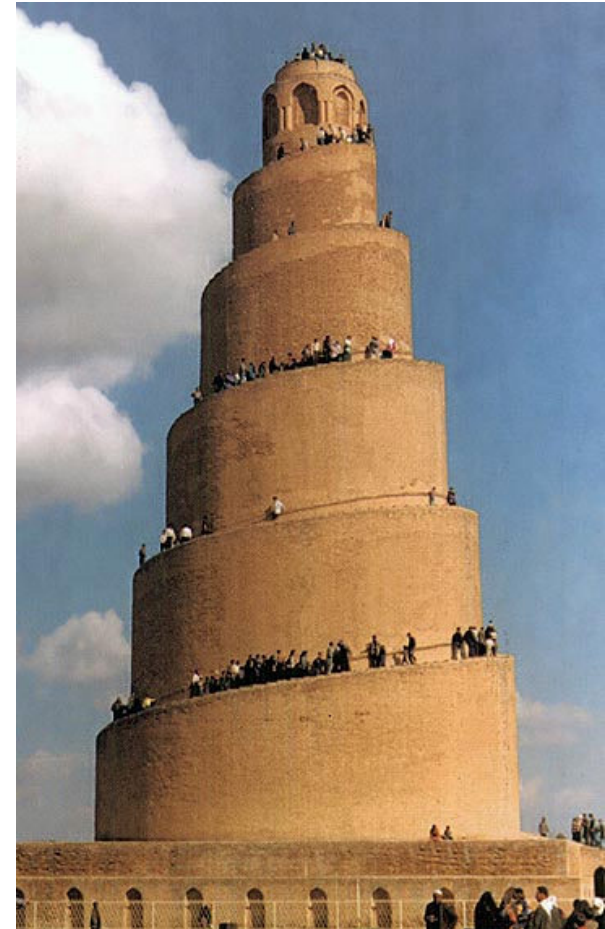

Southern Palace in Lashkar Gah (Afghanistan)

- 12th century
- Famous for its interwoven arcades which appear as ornaments at the outer and inner facade.
- The South Palace is just a small part of a huge complex.



Source: <http://kabulcat.wordpress.com>



Old China

- „Hollow“ bricks
- Bricks with groove and tongue

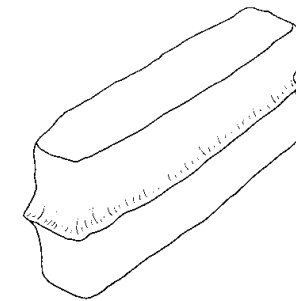
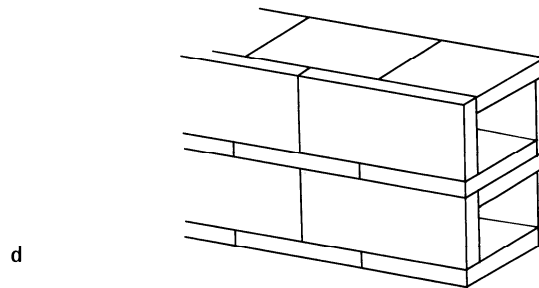
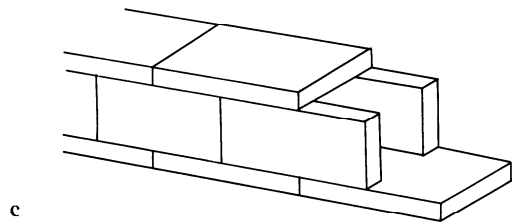
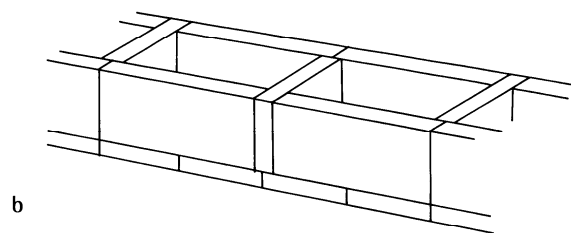
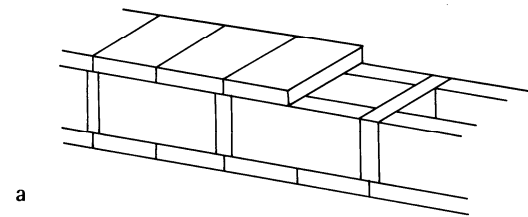

Europe in Middle Ages

- The continuity of ancient Rome was interrupted
- Different size of bricks that conforms to material properties
- Expansion of the brick manufacturing up to north-western Europe (Baltic countries)
- Manufacturing of bricks in the site
- Charcoal burning (in heat) – not a kiln
- Guild system



Malbork Castle (Poland)

- 14th century – seat of the Teutonic knights
- Largest castle in the world by surface area
- Largest brick complex in Europe



Source: <http://osrodek.org>

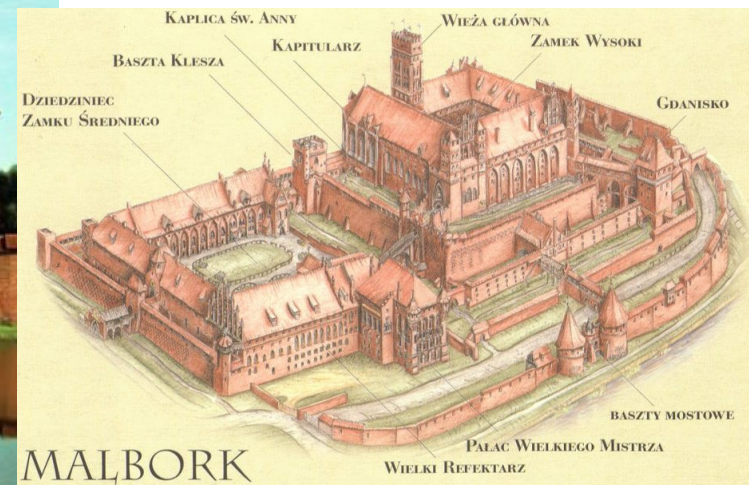

Albi Cathedral (France)

- Found 1287 as a fortress, then build for 200 years
- Sometimes claimed the largest brick building in the world



Source: http://en.wikipedia.org/wiki/Albi_Cathedral#cite_note-1





At the Treshold of Modern Period

(1450 – 1650 AD)

San Lorenzo Cathedral (Florence, Italy)

- 1469 – Filippo Brunelleschi, financed by the Medici
- The first great church of the Renaissance
- Generations of architects, even Michelangelo, failed to finish the facade.



Source: http://cs.wikipedia.org/wiki/San_Lorenzo_%28Florence%29



Hampton Court Palace (London, UK)

- 1514 – 1540 – originally built for Cardinal Thomas Wolsey, later possessed by the King Henry VIII.



Source: <http://www.evanevanstours.co.uk>



Hampton Court Palace (London, UK)

- Decorative chimneys

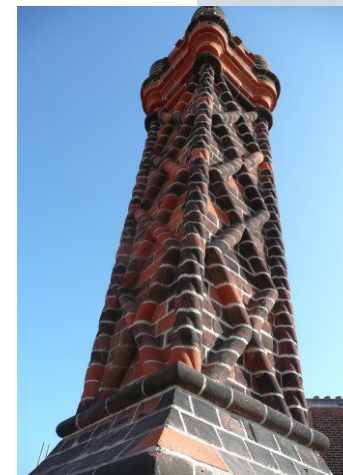
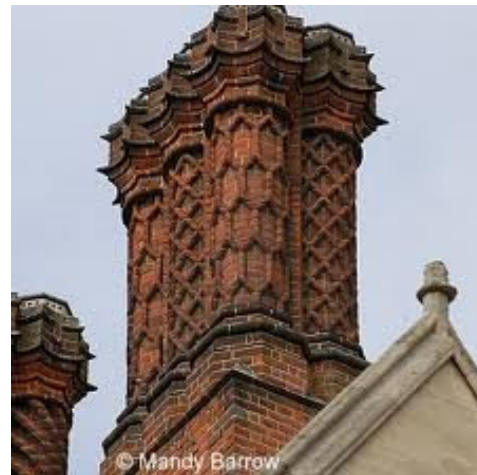
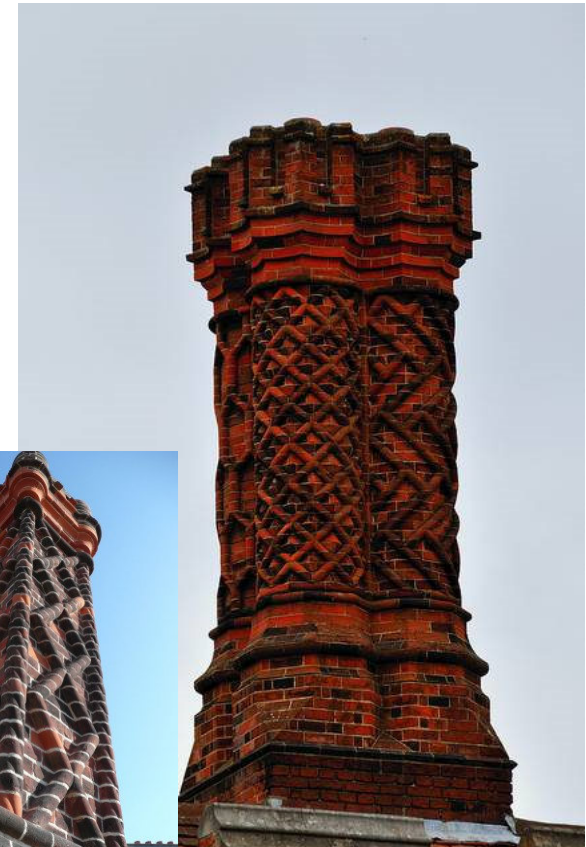

Isfahan Mosque (Iran)

- 1611-1629
- Total area 100x130 m, central courtyard 70x70 m



Source: www.presstv.ir



Great Wall of China

- 700 BC – 1644 AD
- 2,260km (1400 miles) long, running generally east-west along the northern edge of China





17th and 18th Century

Overview

- Netherlands and Belgium – centres of brick production
- France – classic architecture – alternating of stone elements and fair-face brickwork
- Big fire in London 1666 – reconstruction entirely from bricks
- Advancement in crafts

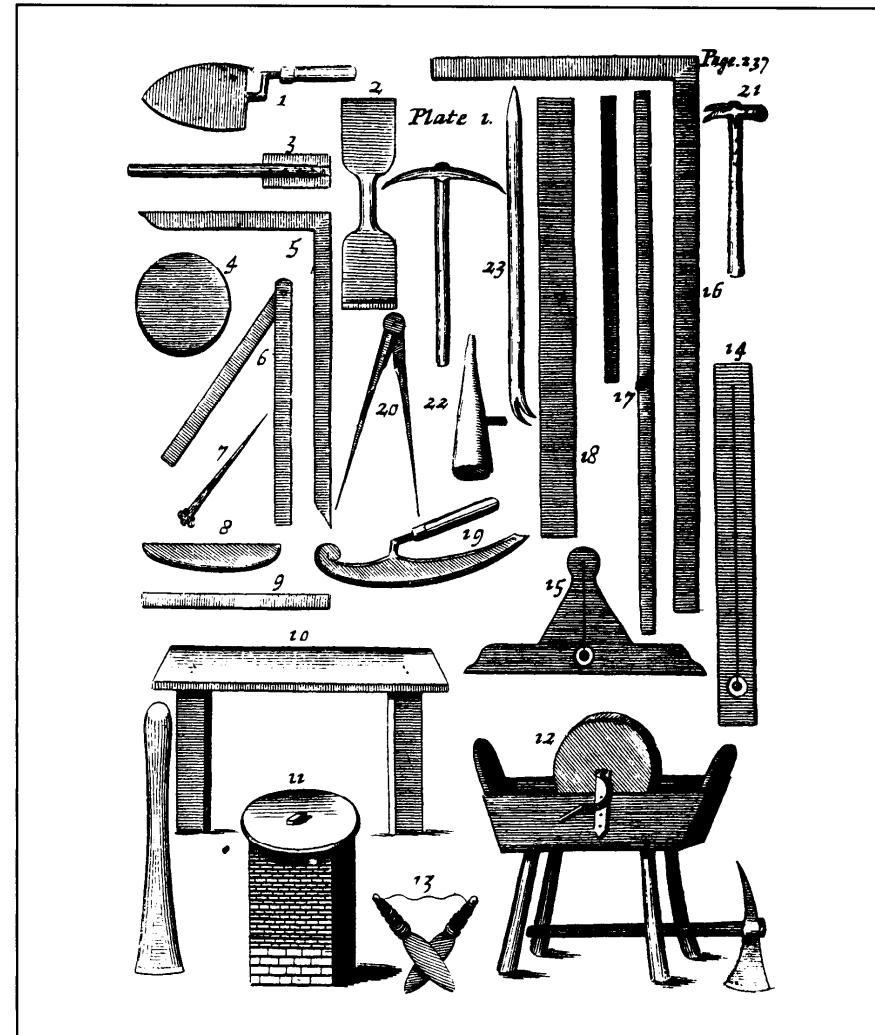

Overview

- Finishing of bricks by grinding, cutting, sculpturing
- Bricks from fine clay without pebbles
- Minimal thickness of joints – lime binder

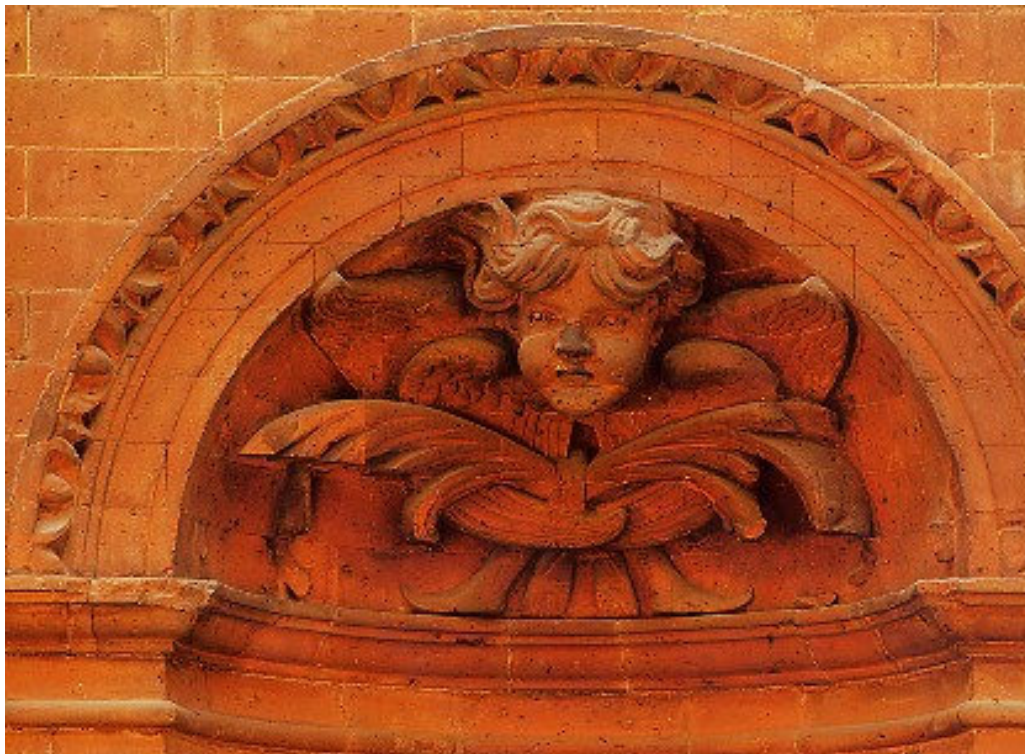

Palais Royal (Paris, France)

- 1605-1615
- Originally, a house of Cardinal Richelieu

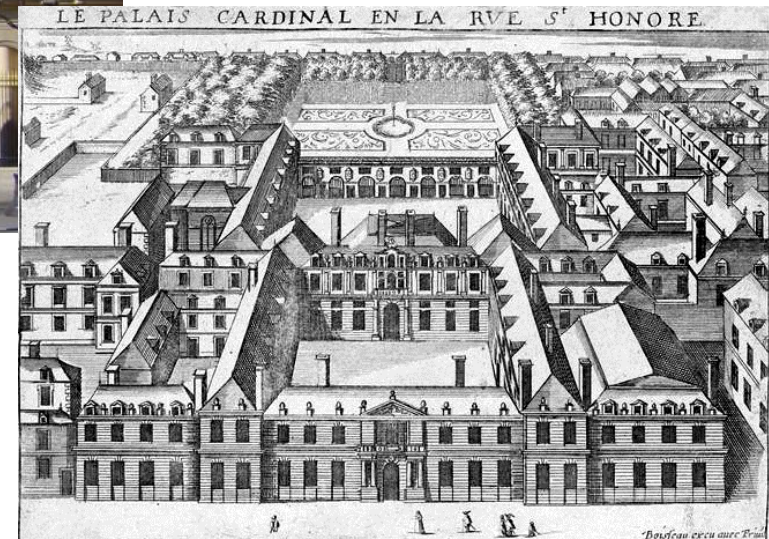

Source: www.paris-architecture.info

St. Pauls Cathedral (London, UK)

- 111 m high

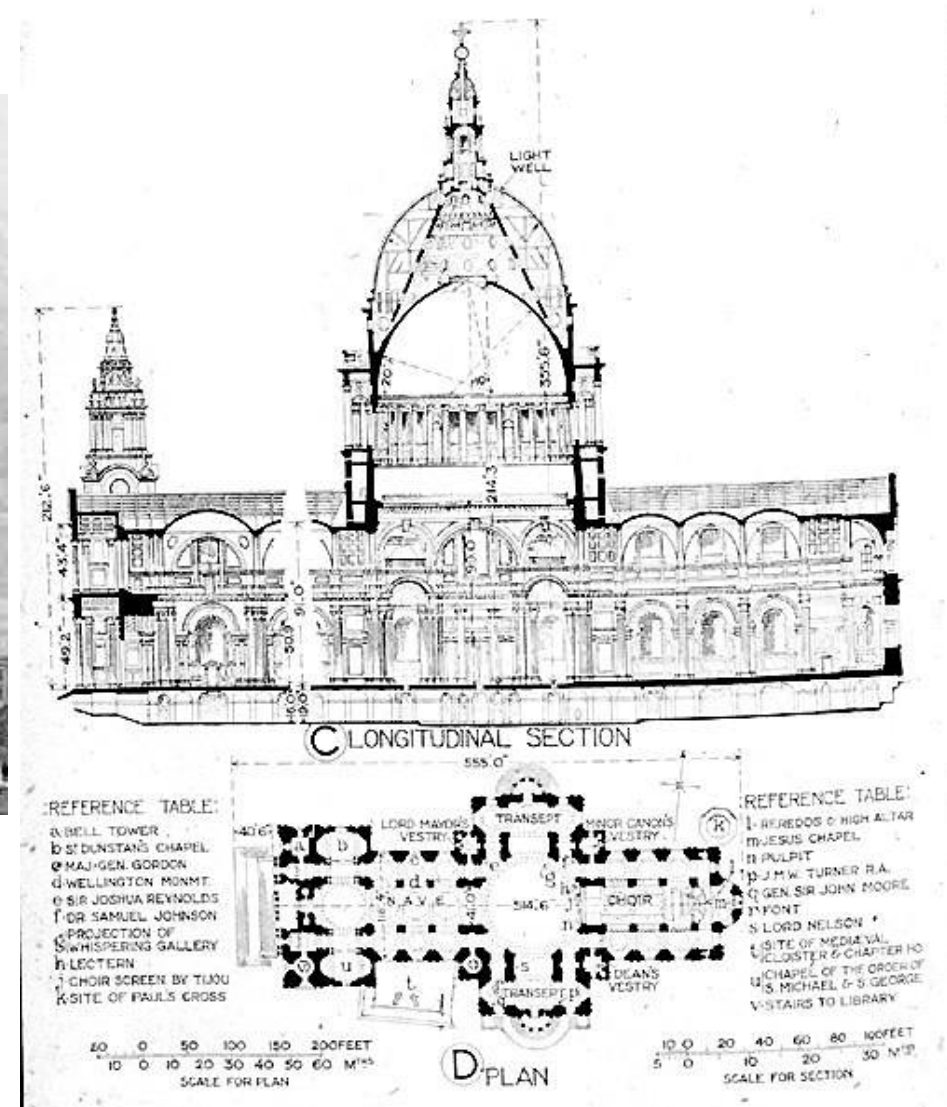

Source: www.explore-stpauls.net

Fortification

- Extensive in the whole Europe
- Big consumption of bricks and bricklayers



Source: www.terezin-malapevnost.estranky.cz





19th Century

Overview

- Industrialization of manufacturing – Preparing of the raw material, forming of bricks, drying and burning in a kiln
- Machine for manufacturing of bricks
- Kiln with lower smoke outlet
- Circular Hoffman kiln

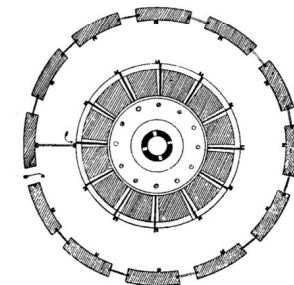
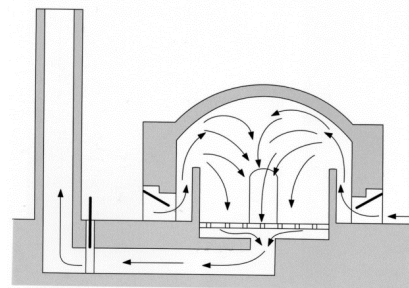
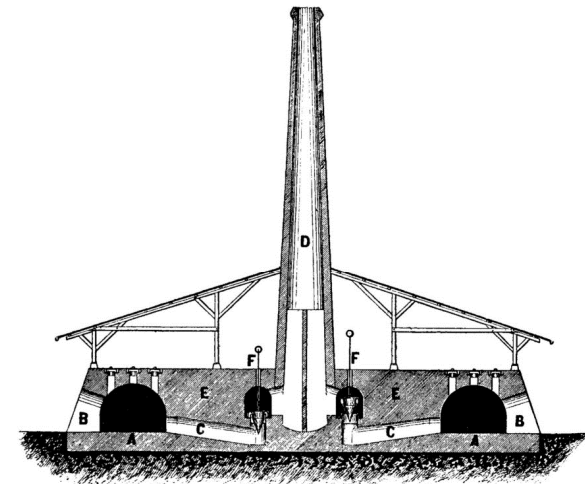
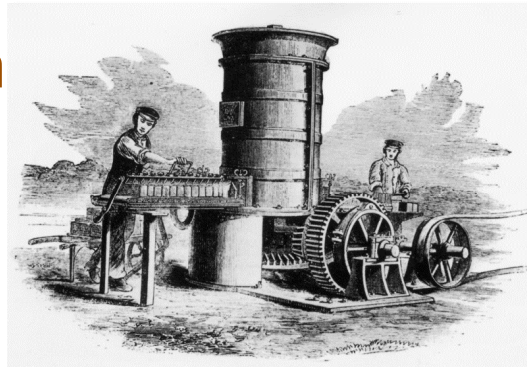

Overview

- Higher strength of masonry – quality of bricks, cement mortar
- Channels, sewers, viaducts



Source: www.itras.cz

concrete.fsv.cvut.cz/~bily



Overview

- Huge building of cheap houses in industrial areas
- Developing of new masonry elements and shapes of bricks, hollow bricks – beginning of the 19th century
- Flooring systems: conventional – timbered and arches, new – ceramics, steel, concrete, combinations
- Reinforced masonry (Marc Brunel – tunnel below Thames)
- Facades with ornamentation, terracotta elements in period of neo-styles (England, Germany)



Midland Grand Hotel (London, UK)

- 1866-1877, financed by Midland Railway Company
- Frontispiece of St. Pancras railway station



Source:

www.telegraph.co.uk



Saulnier Mill (Noisel by Paris, France)

- Part of Menier Chocolate Factory
- Rich ornamentation

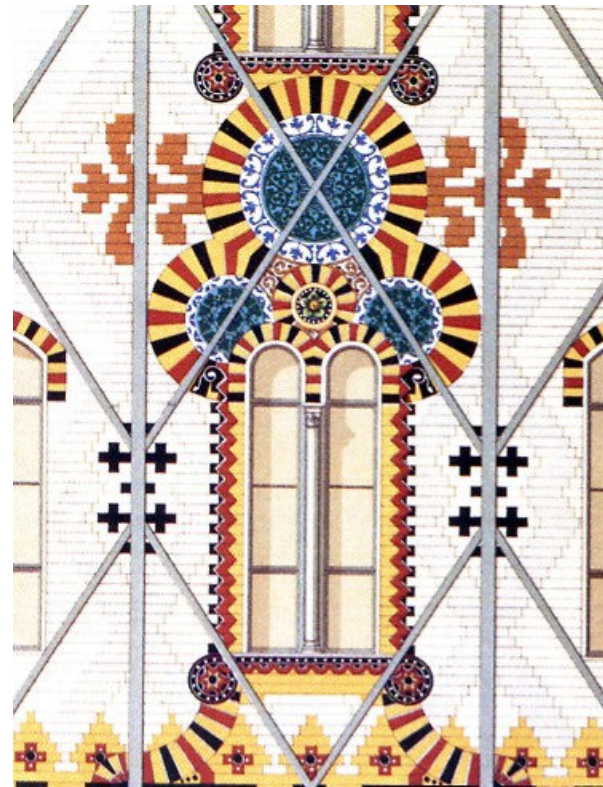

Source: http://en.wikipedia.org/wiki/File:Moulin_Saulnier.jpg



Monadnock Building (Chicago, USA)

- 1891 Burnham & Roots
- 16 storeys plus attic, 66 m high
- The last skyscraper with masonry load-bearing walls



Source: http://en.wikipedia.org/wiki/Monadnock_Building

concrete.fsv.cvut.cz/~bily



Monadnock Building (Chicago, USA)

- External load-bearing walls made of masonry; thickness varies between 1.8 m in the basement and 0.46 m in the top floor
- Horizontal loads transferred by rivetted cast-iron internal frames

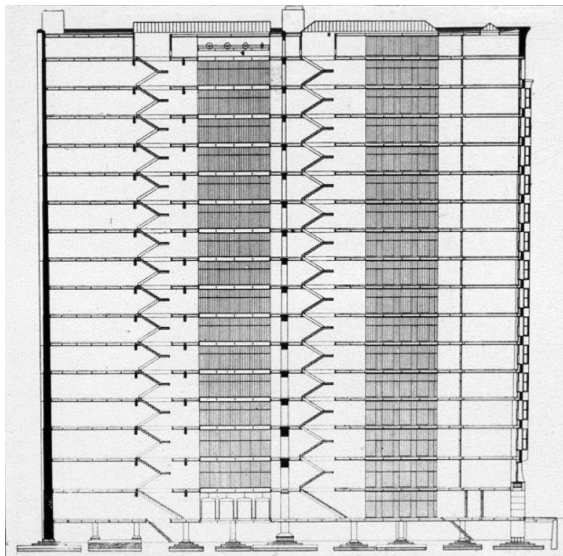

Source: www.columbia.edu

concrete.fsv.cvut.cz/~bily

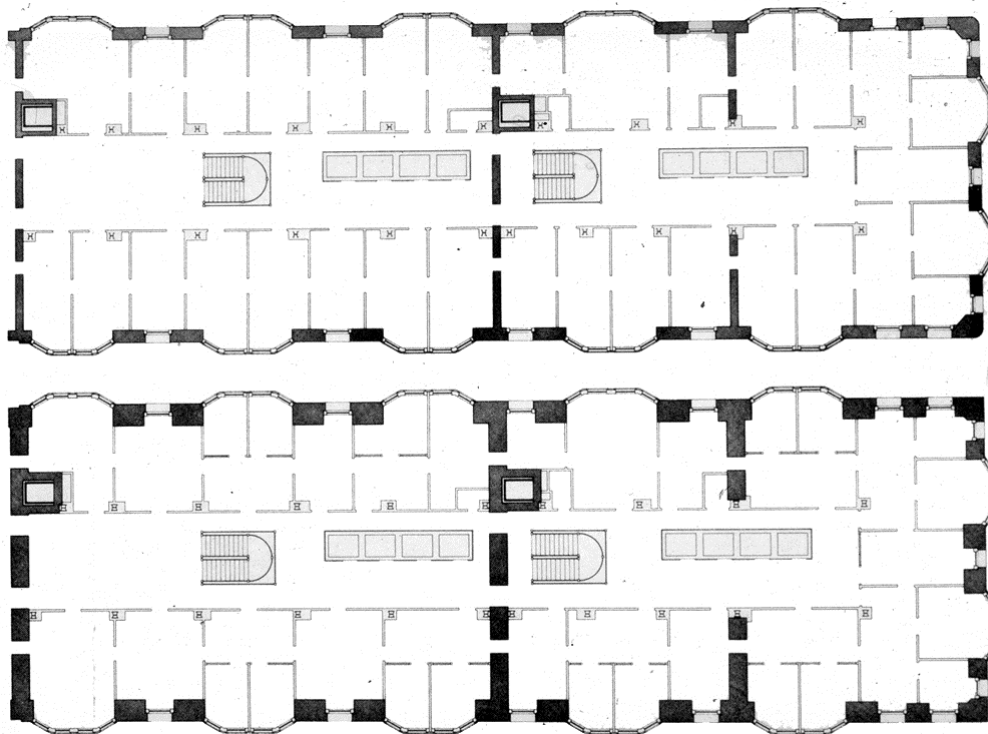

Monadnock Building – problems

- Lighting
 - Bay windows, offices separated from corridors by glazed walls
 - Corridor clad with white marble
 - Stair shaft with skylights, staircase with treads from white marble and open riser
- Foundation
 - Saturated soils
 - Design settlement was 20 cm, exceeded in 1905
 - 1948 – settlement more than 50 cm
 - Raft foundation with steel ribs and 60 cm concrete slab
 - Foundation slab reaches 3.4 m behind the perimeter of the building
 - During construction of subway, supporting caissons were added under eastern wall, reaching to bearing slates





Modern Architecture

(since 1900)

Overview

- 20th century – concrete, steel, glass
- Masonry – new possibilities, new forms, new materials
- Combination of materials
- High quality

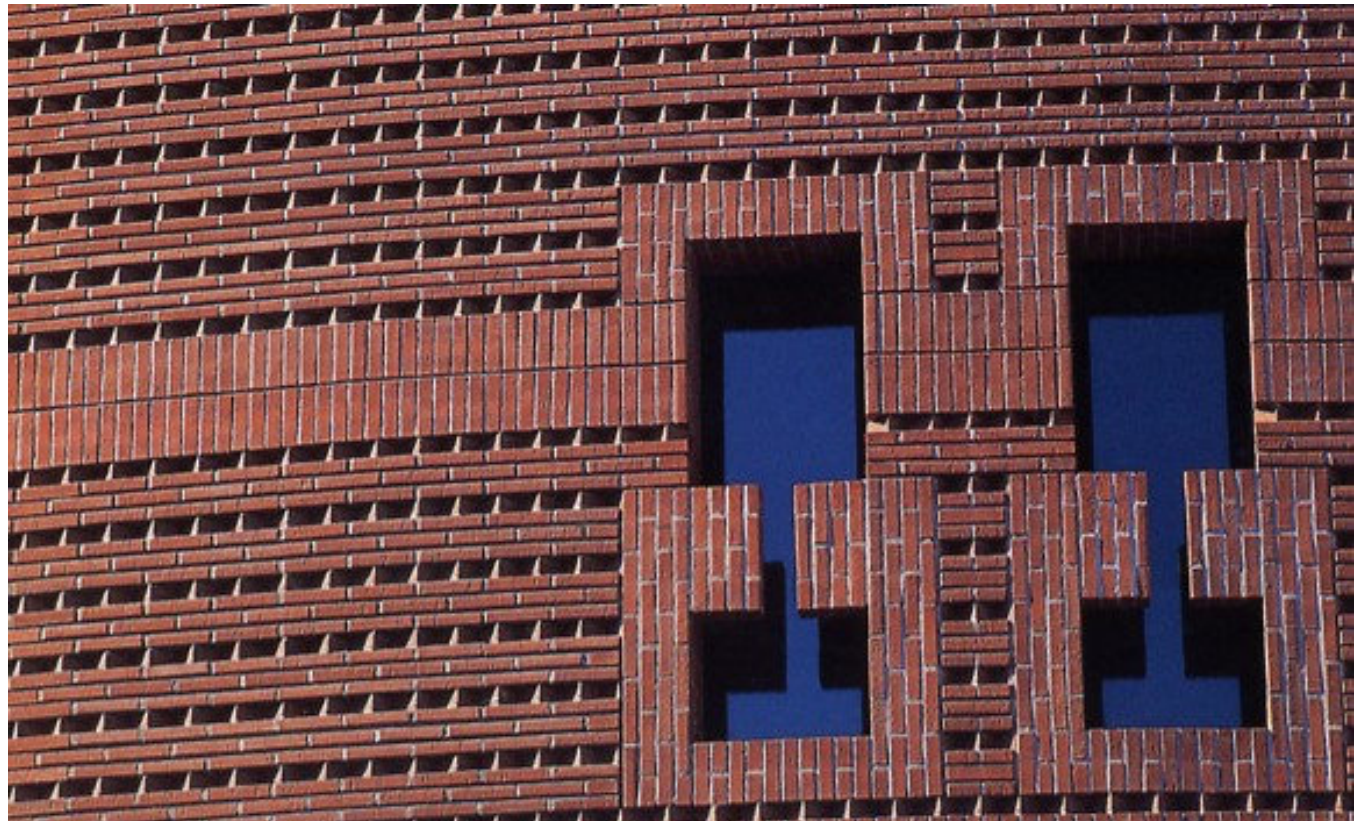

La Sagrada Familia (Barcelona, Spain)

- Antonio Gaudí – Art Nouveau
- Started 1882



concrete.fsv.cvut.cz/~bily

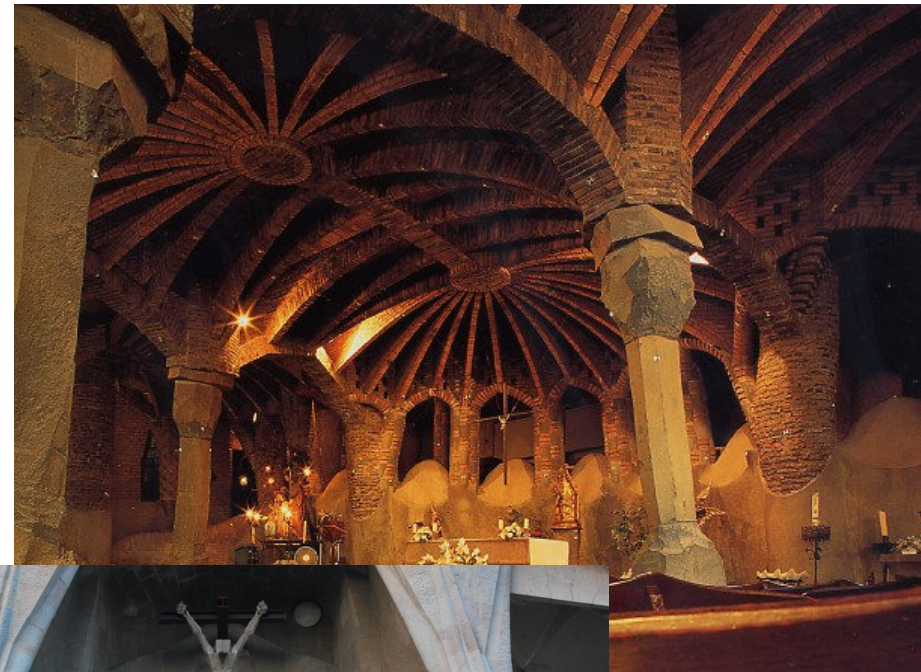

Stock Exchange of Amsterdam (Netherlands)

- Hendrik Petrus Berlage 1897 – 1909
- Load-bearing masonry with iron trusses for glazed roof
- Flat brick arches, iron trusses spanning hall



City Hall of Hilversum (Netherlands)

- Willem Dudock, 1928-31



Johnson Wax Building (Racine, Wisconsin, USA)

- Frank Lloyd Wright 1936 – 1944, office building



Engineering School in Leicester (UK)

- James Stirnling 1959



Source: [1066interests.tumblr.com](https://www.tumblr.com/1066interests)

concrete.fsv.cvut.cz/~bily



Indian Institute for Management (Ahmedabad, India)

- Louis Kahn 1974



Source: indian-institute-of-management-ahmedabad.learnhub.com

concrete.fsv.cvut.cz/~bily

Museum for Roman Art (Merida, Spain)

- Rafael Moneo 1985



Source: www.superstock.com; www.panoramio.com



Olympic Housing in Barcelona (Spain)

- José Lapena 1991



Source: www.wienerberger.com

concrete.fsv.cvut.cz/~bily



Olympic Housing in Barcelona (Spain)

- José Lapena 1991



Source: www.wienerberger.com

concrete.fsv.cvut.cz/~bily



Brdo Sightseeing Tower (Brdo Mountain, Czech Republic)

- 2001 – 2004
- Natural stone masonry



Source: Tereza Mokošová

concrete.fsv.cvut.cz/~bily

Boundary Wall of Velehrad Church (Velehrad, Czech Republic)

- 2012, housing 8 valuable statues of the saints



Source: Tereza Mokořová

concrete.fsv.cvut.cz/~bily



Modern Masonry Houses

- Combination with other materials
- Atypical shapes



Source: www.trendir.com

concrete.fsv.cvut.cz/~bily



Thermal Insulation Hollow Blocks

- Widely used in dwelling houses
- Thin layer mortar and large-scale blocks facilitate the construction process



Source: Tereza Mokrošová

concrete.fsv.cvut.cz/~bily

