



The
University
Of
Sheffield.

Shear Panel Component in the Vicinity of Beam-column Connections in Fire

Guan Quan
University of Sheffield

What is Shear Buckling?

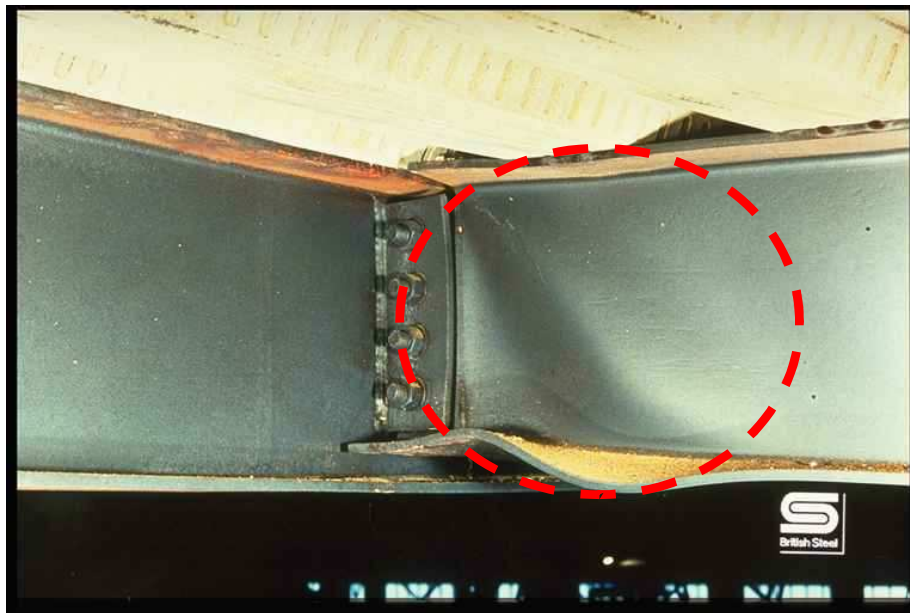
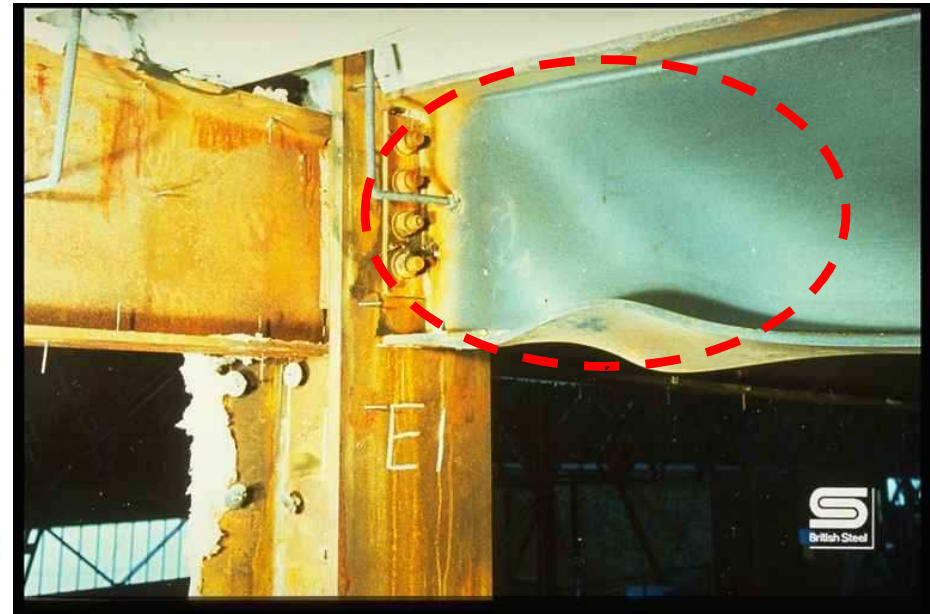
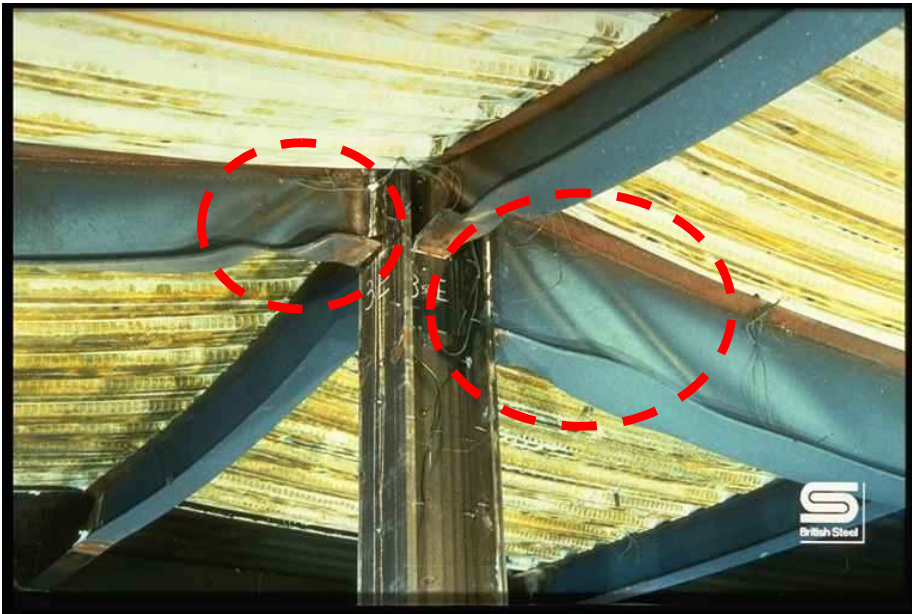

- ① Shear Buckling Near the Beam-Column Connection
- ② Primary Beam Shear Buckling
- ③ Secondary Beam Shear Buckling

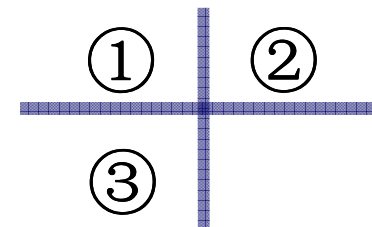



The
University
Of
Sheffield.

How to Create Shear Panel Elements?

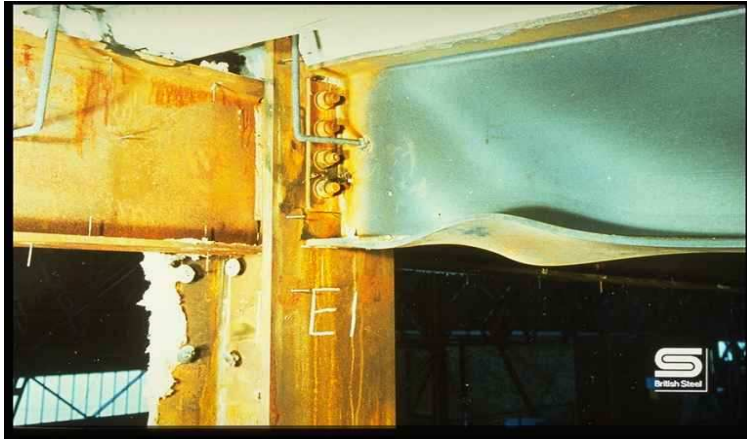



How to Create Shear Panel Elements?

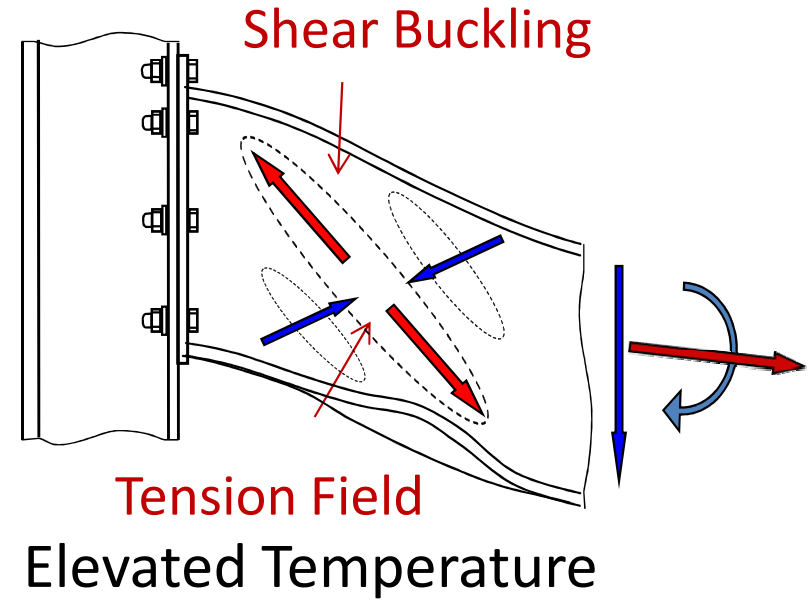
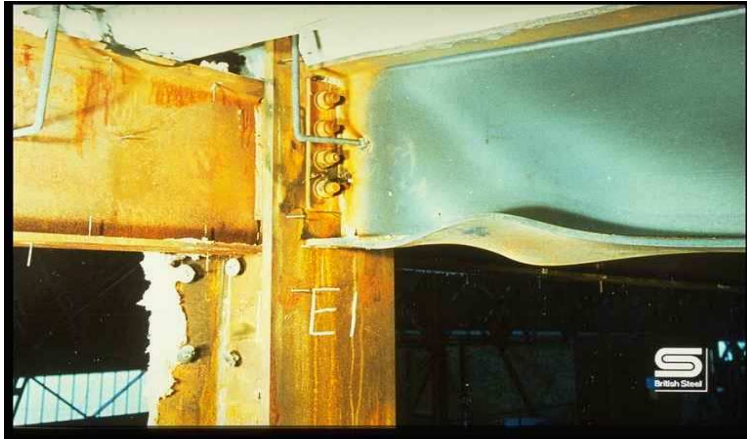



How to Create Shear Panel Elements?

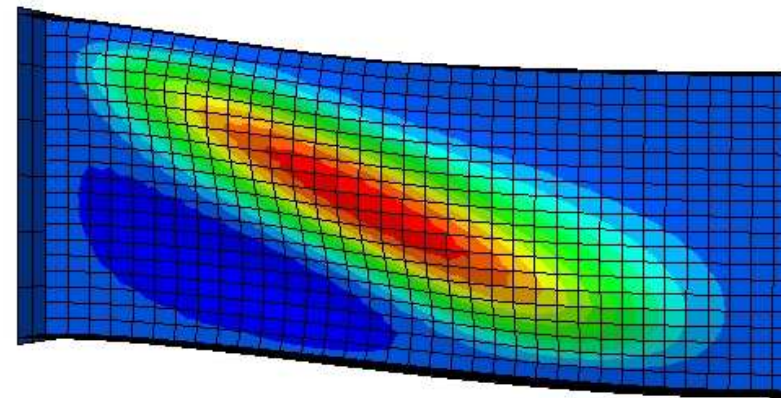
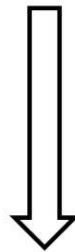
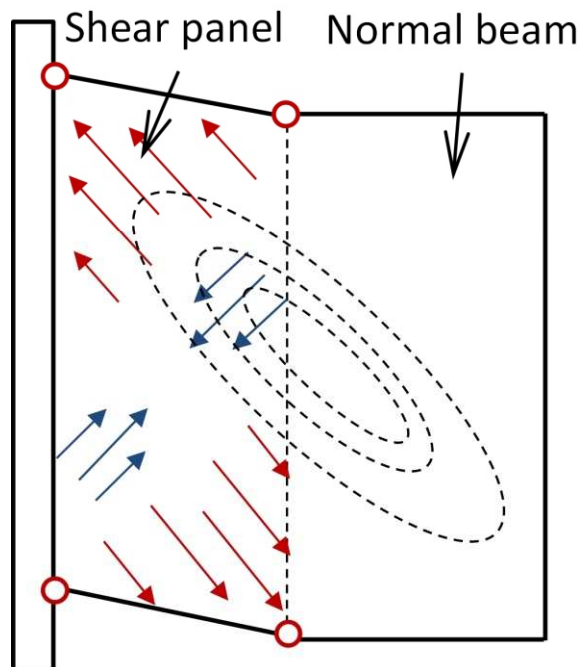
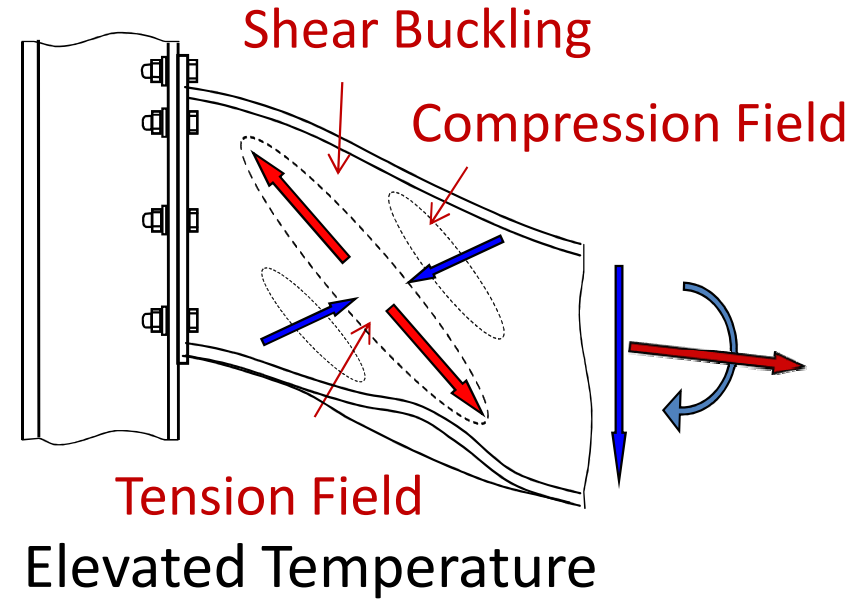
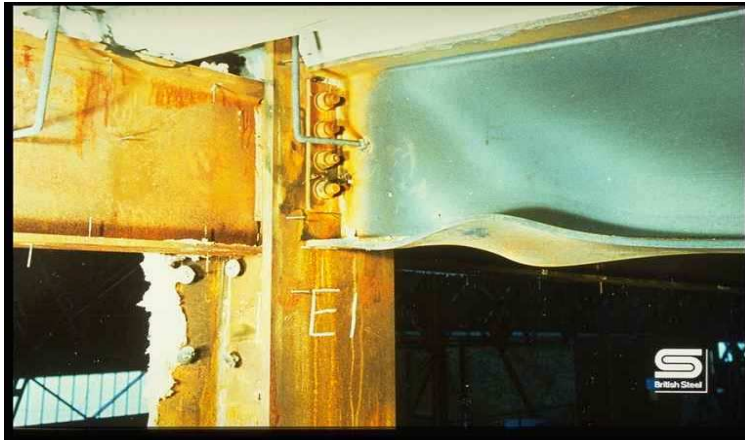



How to Create Shear Panel Elements?

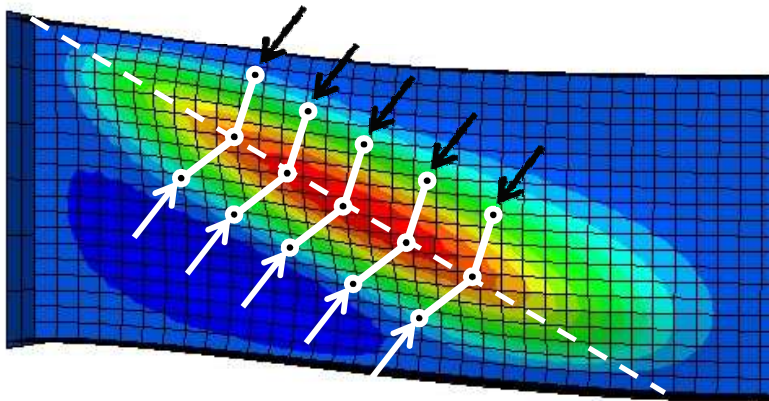
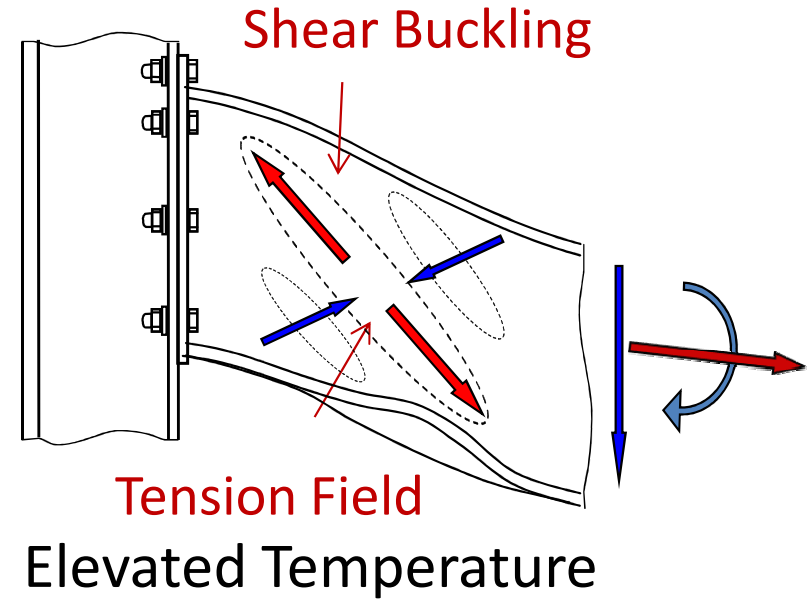
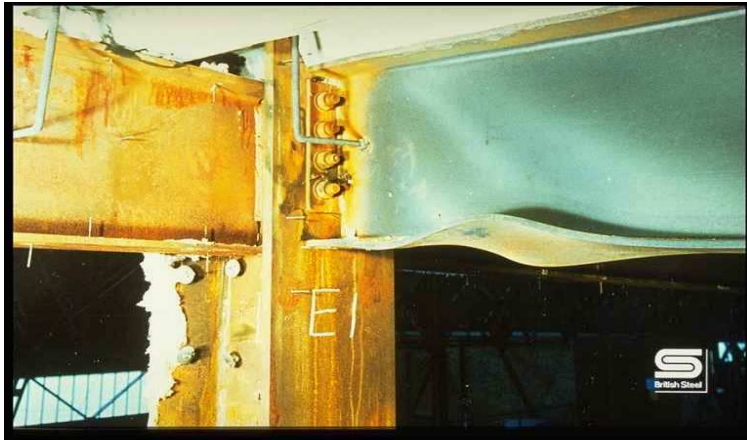



How to Create Shear Panel Elements?

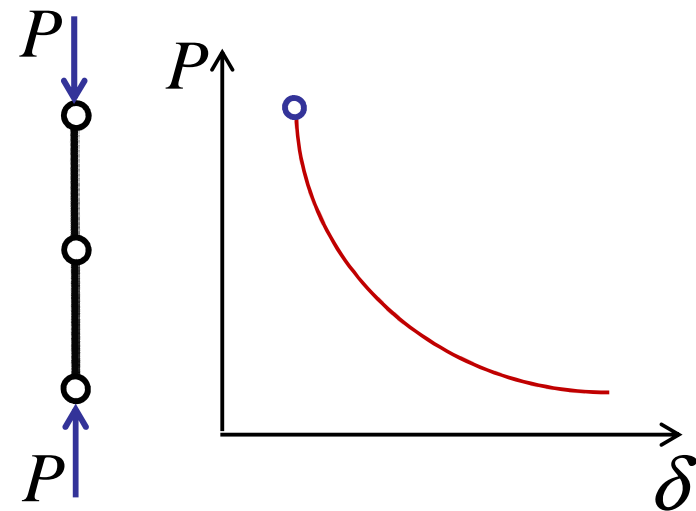
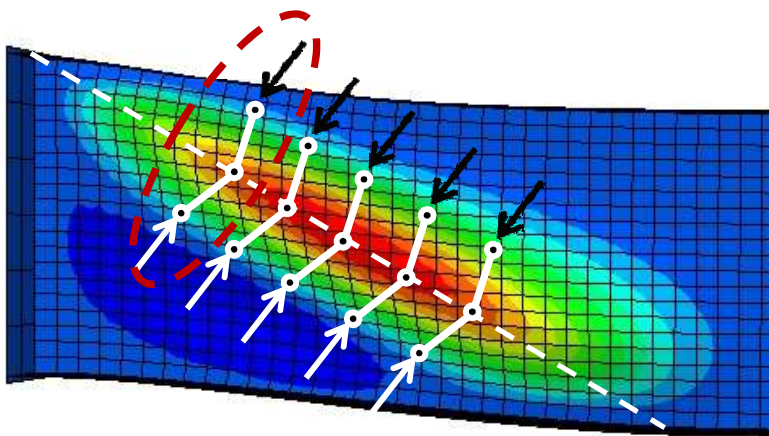
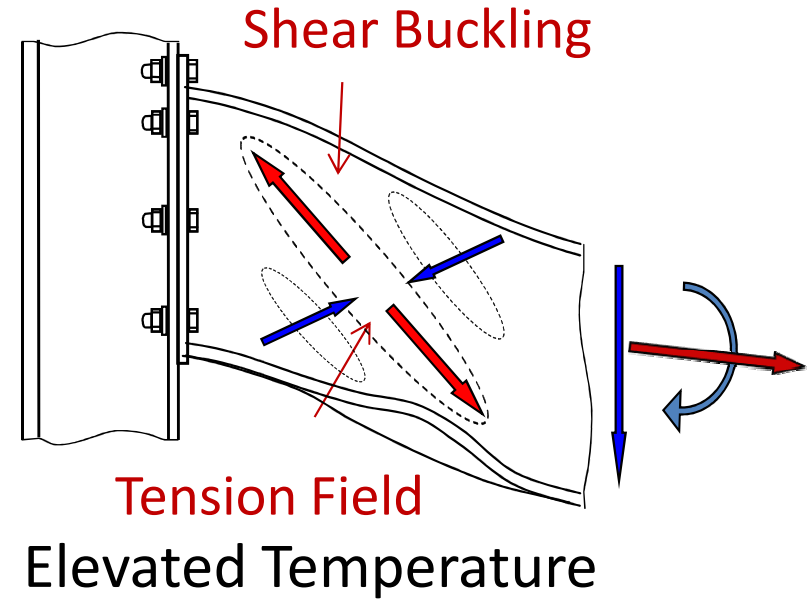
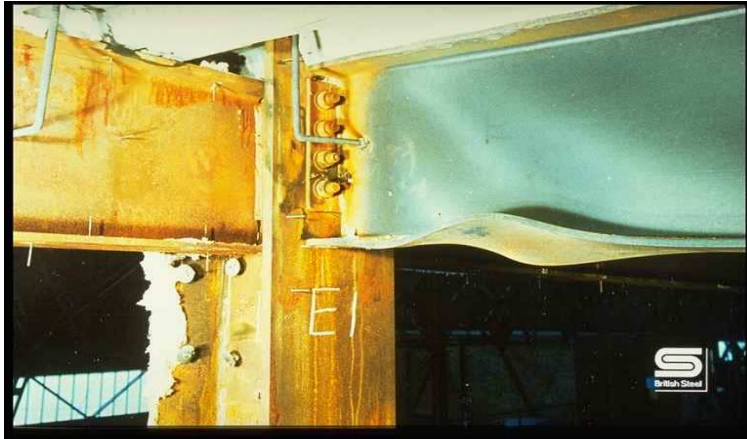



How to Create Shear Panel Elements?

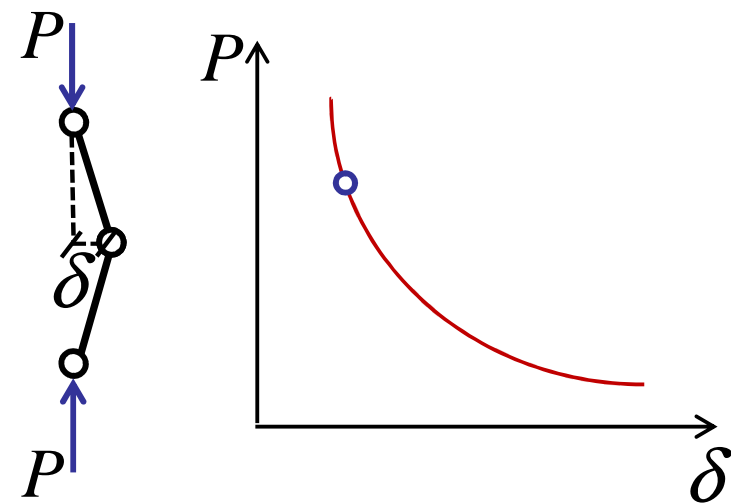
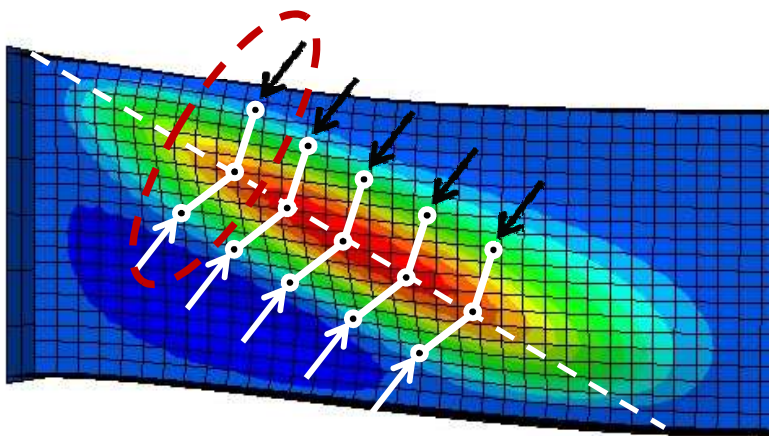
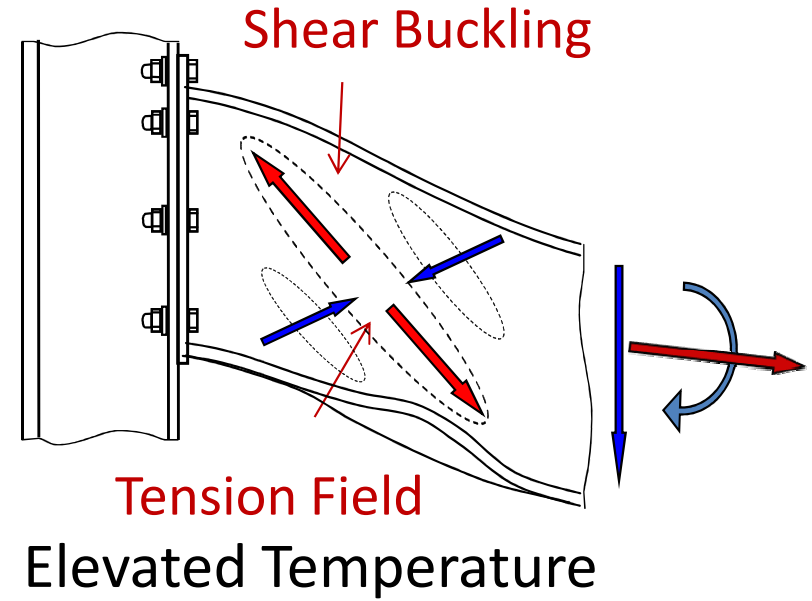
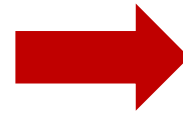
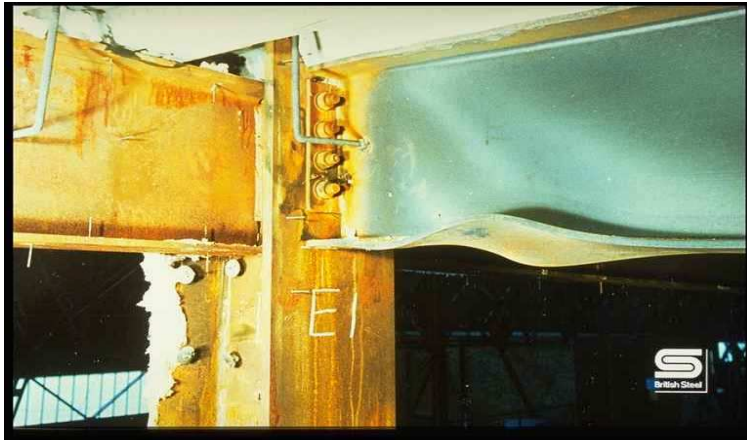



How to Create Shear Panel Elements?

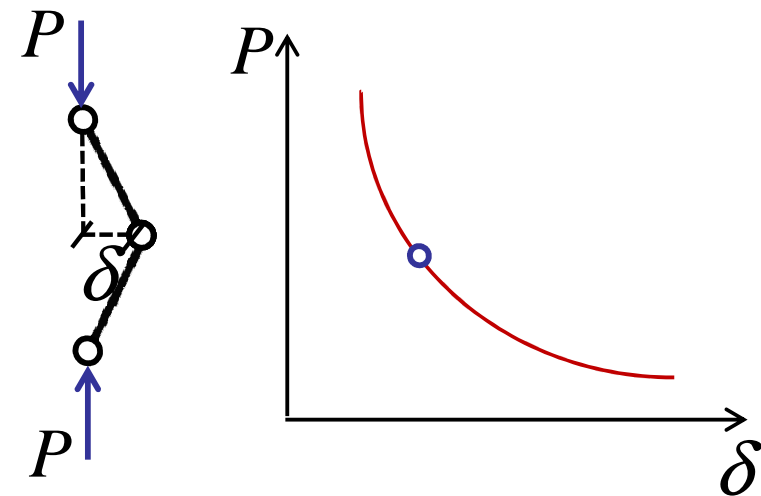
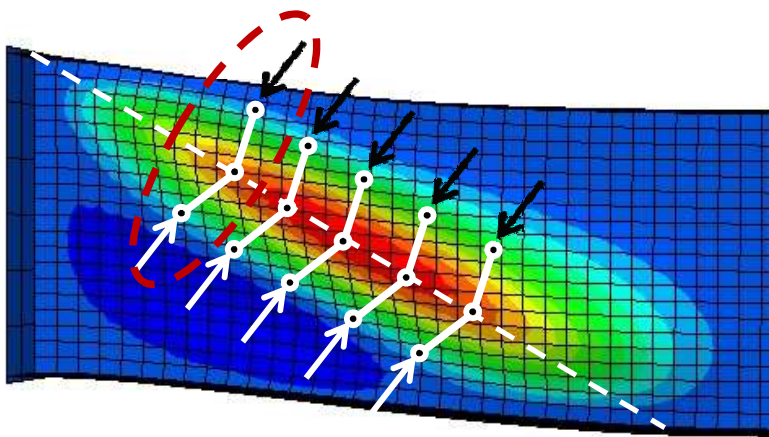
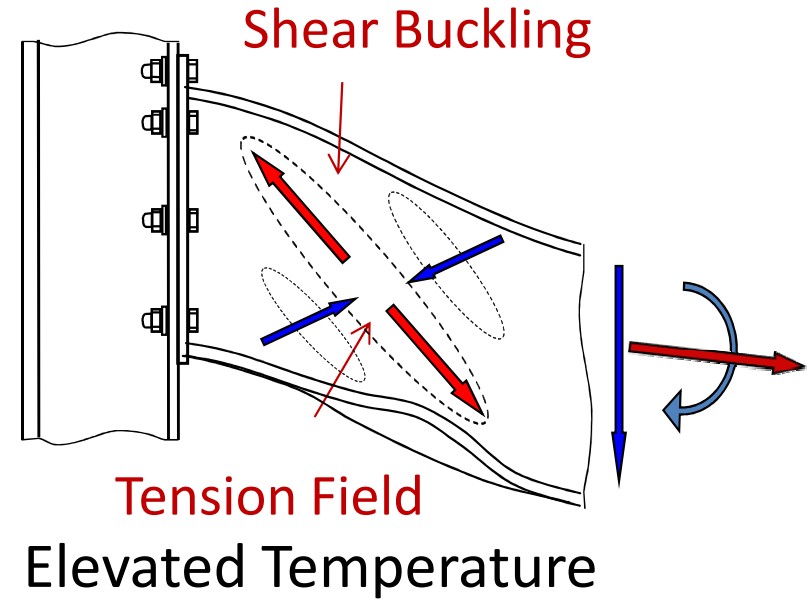
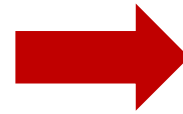
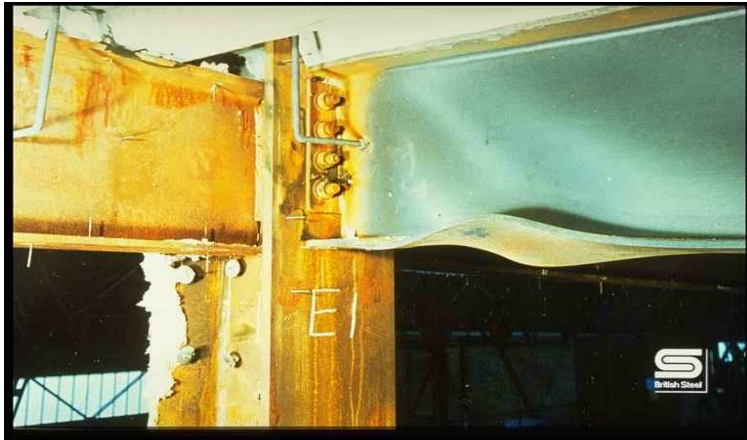

How to Create Shear Panel Elements?

Internal work = External work

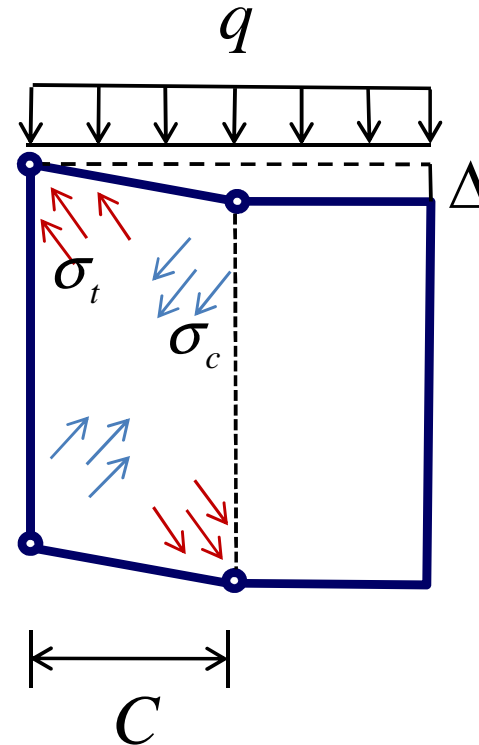
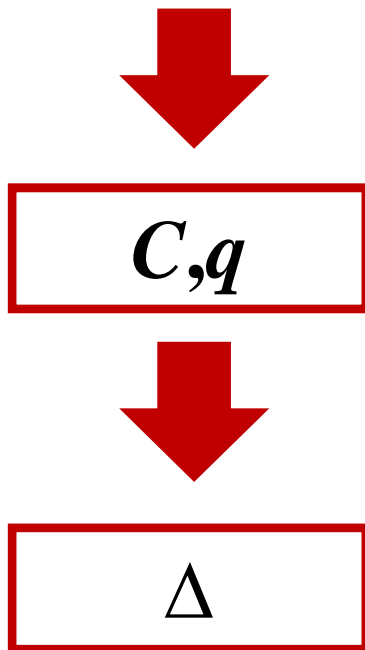

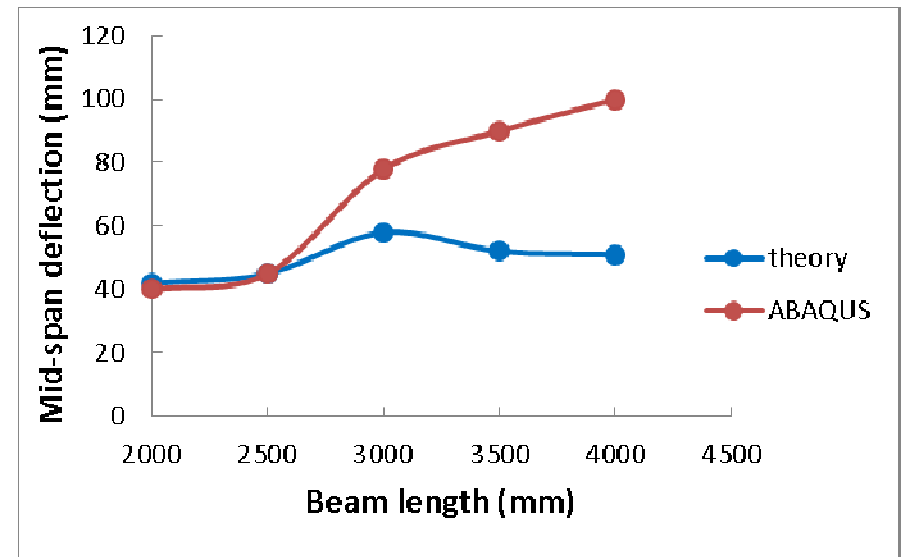
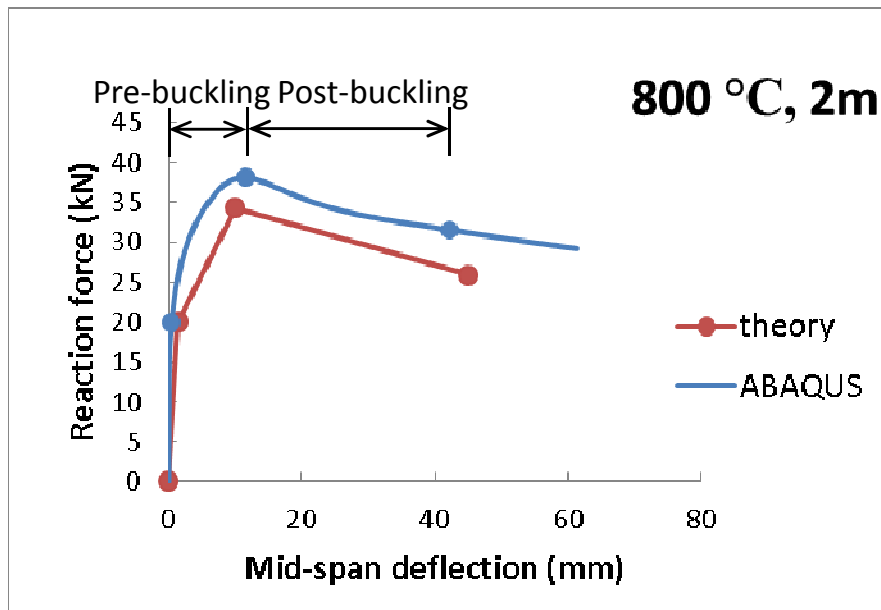
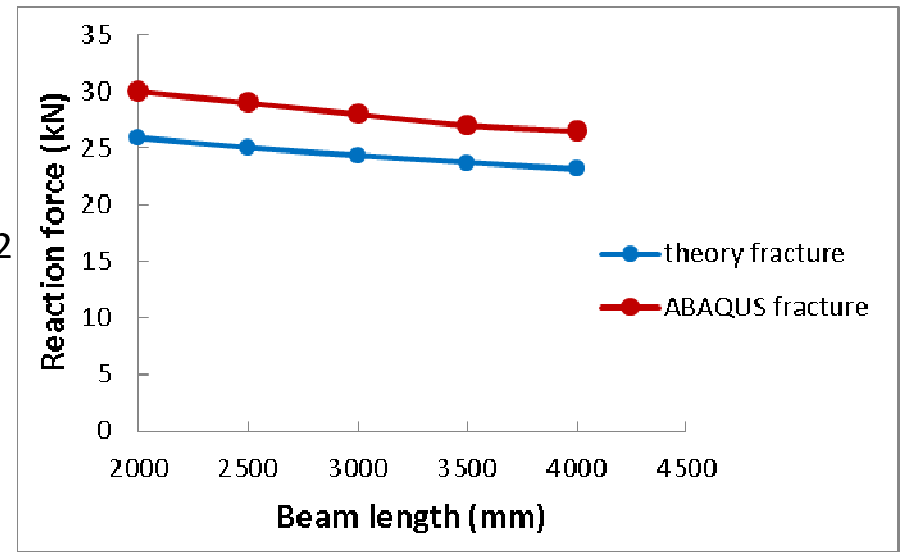
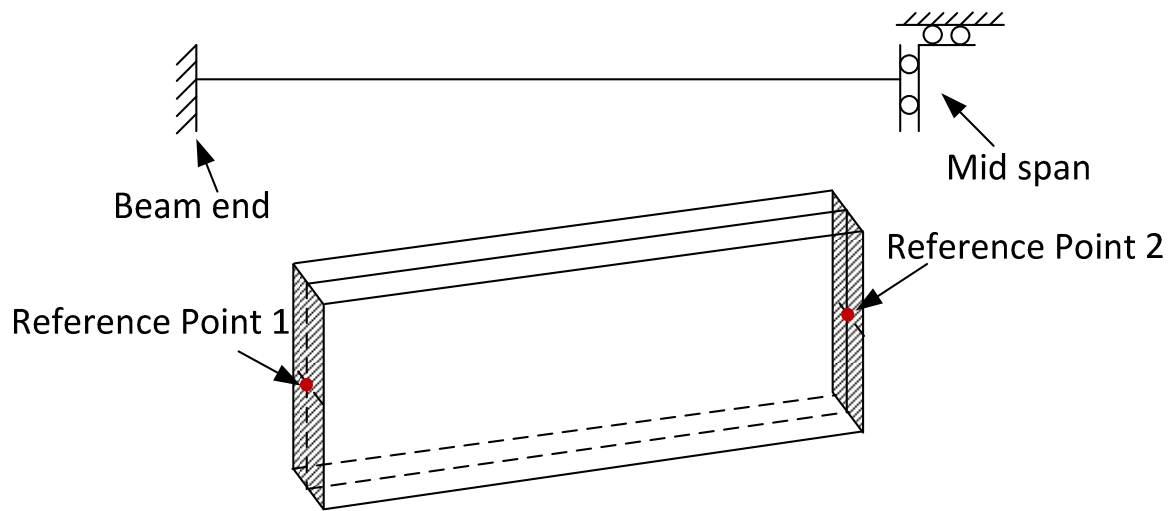



Component-based model

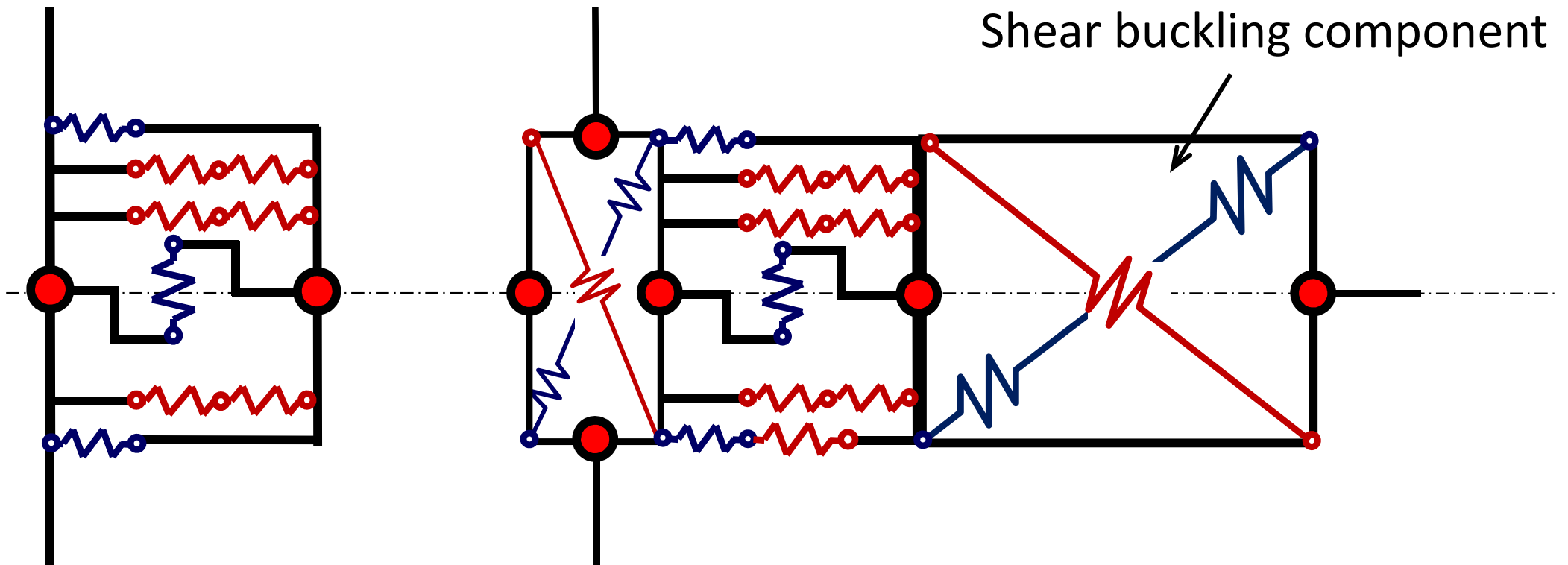



Component-based model

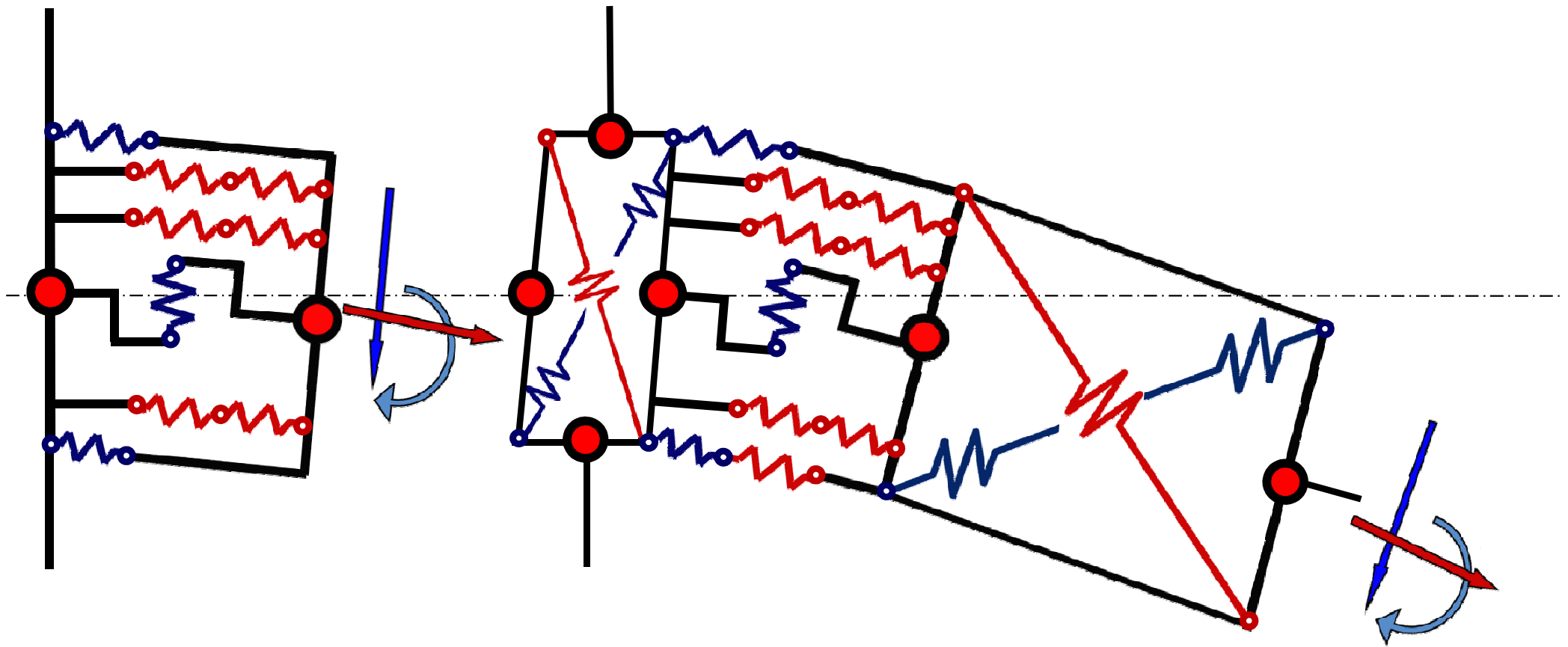



The
University
Of
Sheffield.

Thanks for your attention!

Email: g.quan@sheffield.ac.uk